

```

2 public class ZIntSET {
3     private Node root;
4     private static class Node {
5         public final int key;
6         public Node left, right;
7         public Node(int key) { this.key = key; }
8     }
9
10    public int size () {
11        return size (root);
12    }
13    private static int sz = 0;
14    private static int size (Node x) {
15        if (x == null) return sz;
16        sz = sz + 1;
17        size (x.left);
18        size (x.right);
19        return sz;
20    }
21
22    public static void main (String[] args) {
23        ZIntSET tree = ZIntSET.fromString ("41 21 61 11 31");
24        tree.size ();
25        tree.size ();
26    }
27
--

```

ZIntSET	sz = 0
---------	--------

@2 : ZIntSET.size # 11

@1 : ZIntSET.main # 24

--

ZIntSET

Node	key = 41
------	----------

Node	key = 21
------	----------

Node	key = 61
------	----------

Node	key = 11
------	----------

Node	key = 31
------	----------

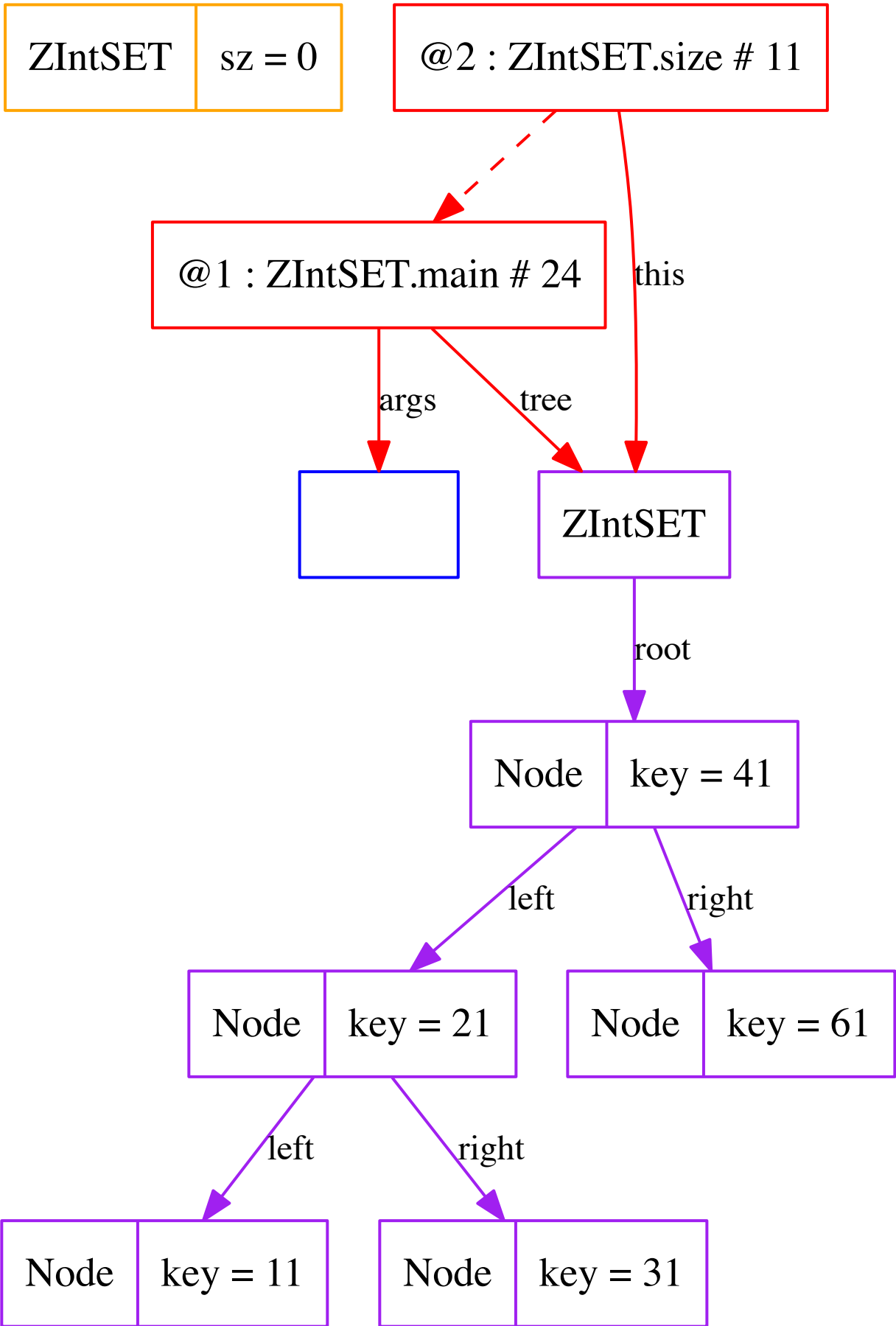

ZIntSET	sz = 0
---------	--------

@2 : ZIntSET.size # 12

@1 : ZIntSET.main # 24

--

ZIntSET

Node	key = 41
------	----------

Node	key = 21
------	----------

Node	key = 61
------	----------

Node	key = 11
------	----------

Node	key = 31
------	----------

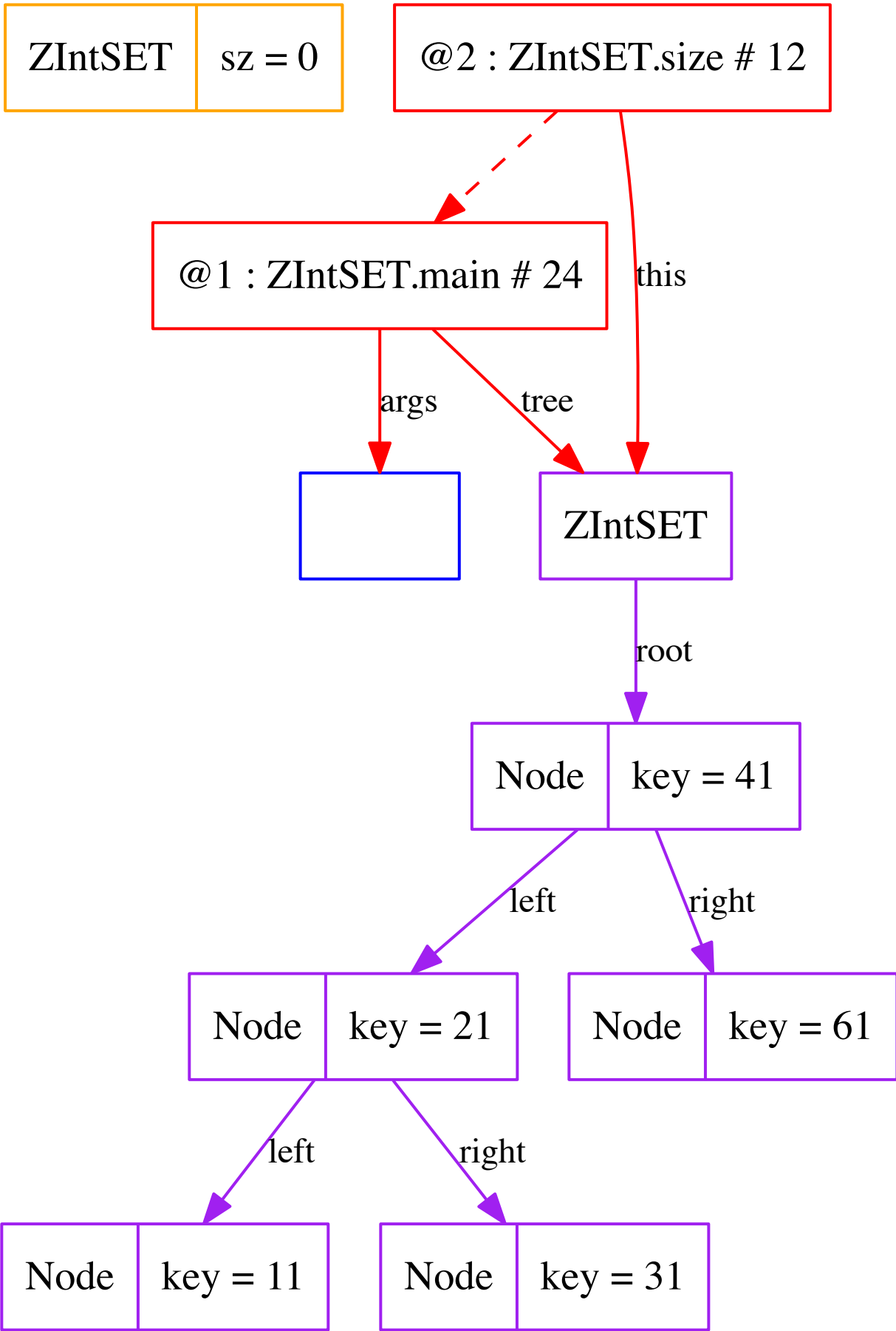

ZIntSET	sz = 0
---------	--------

@3 : ZIntSET.size # 15

@2 : ZIntSET.size # 11

@1 : ZIntSET.main # 24

--

ZIntSET

Node	key = 41
------	----------

Node	key = 21
------	----------

Node	key = 61
------	----------

Node	key = 11
------	----------

Node	key = 31
------	----------

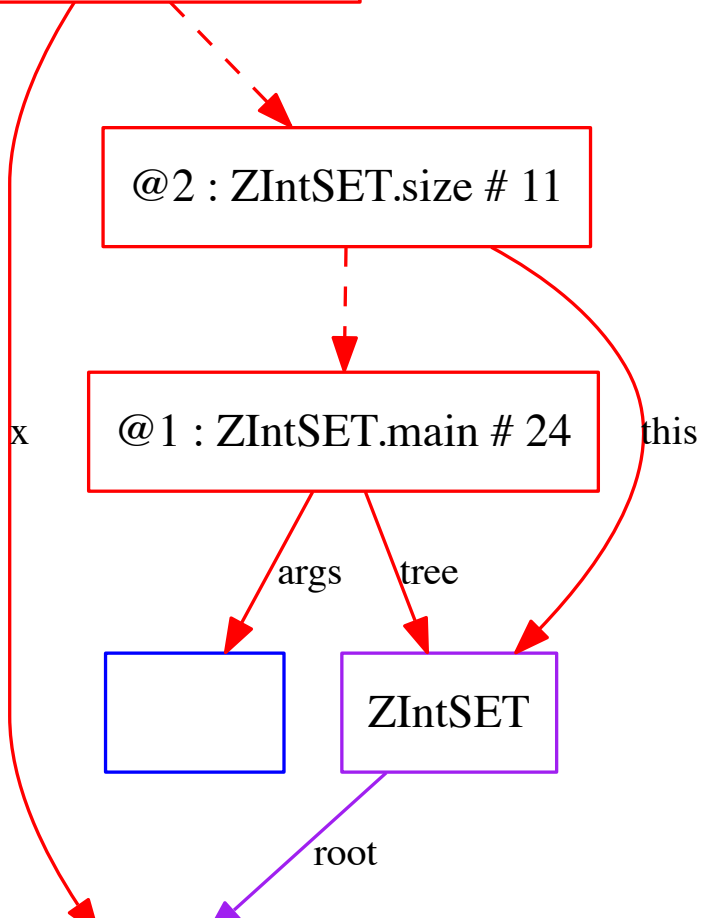

ZIntSET	sz = 0
---------	--------

@3 : ZIntSET.size # 16

@2 : ZIntSET.size # 11

@1 : ZIntSET.main # 24

--

ZIntSET

Node	key = 41
------	----------

Node	key = 21
------	----------

Node	key = 61
------	----------

Node	key = 11
------	----------

Node	key = 31
------	----------

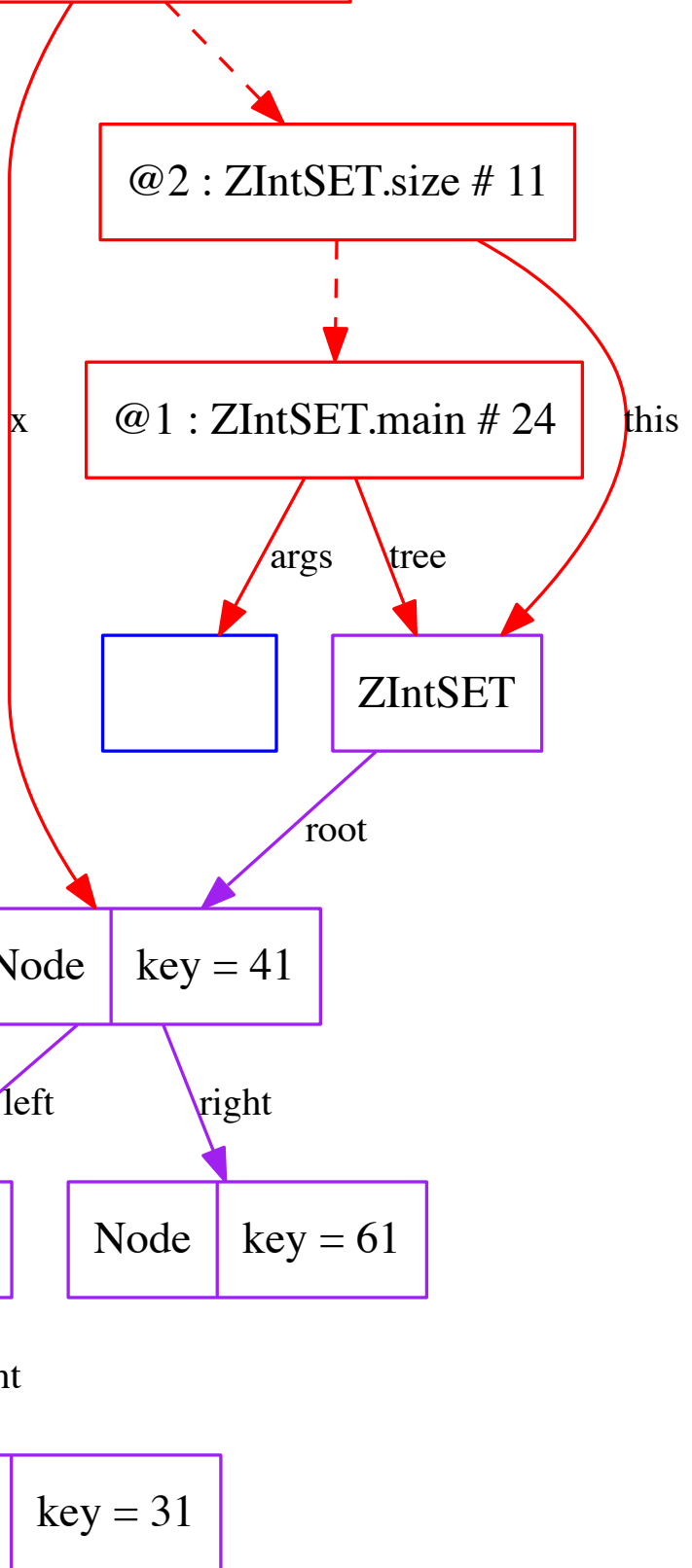

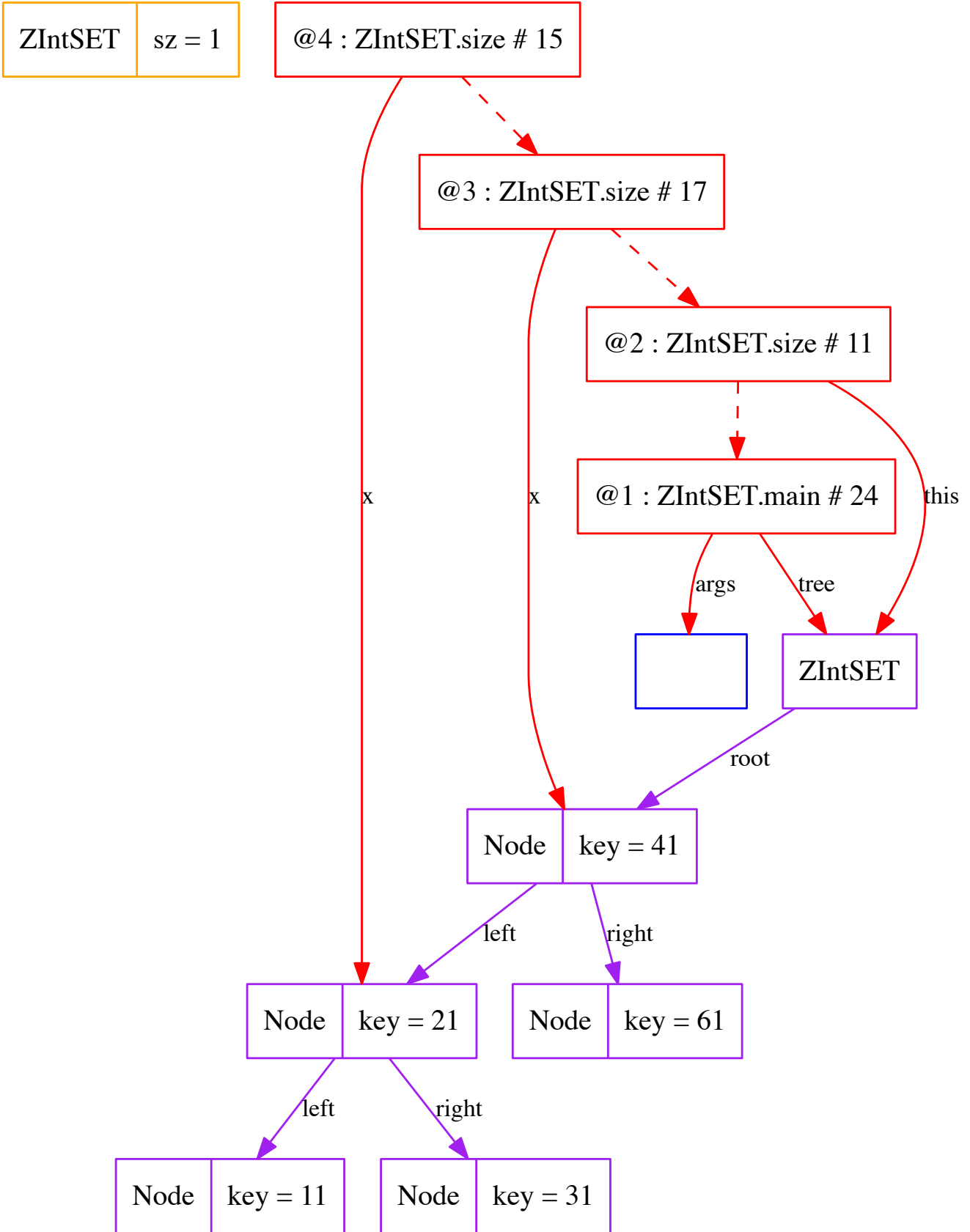

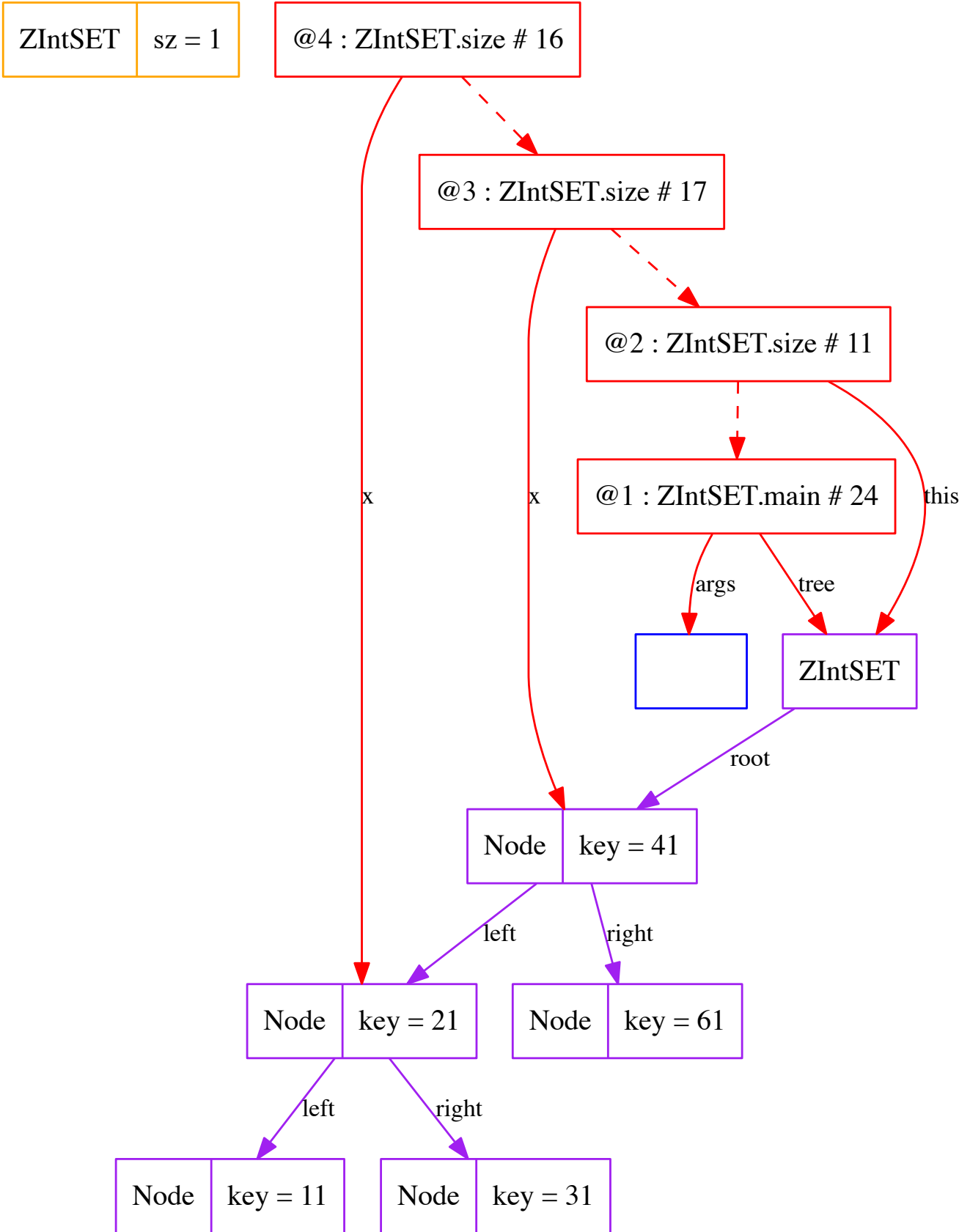

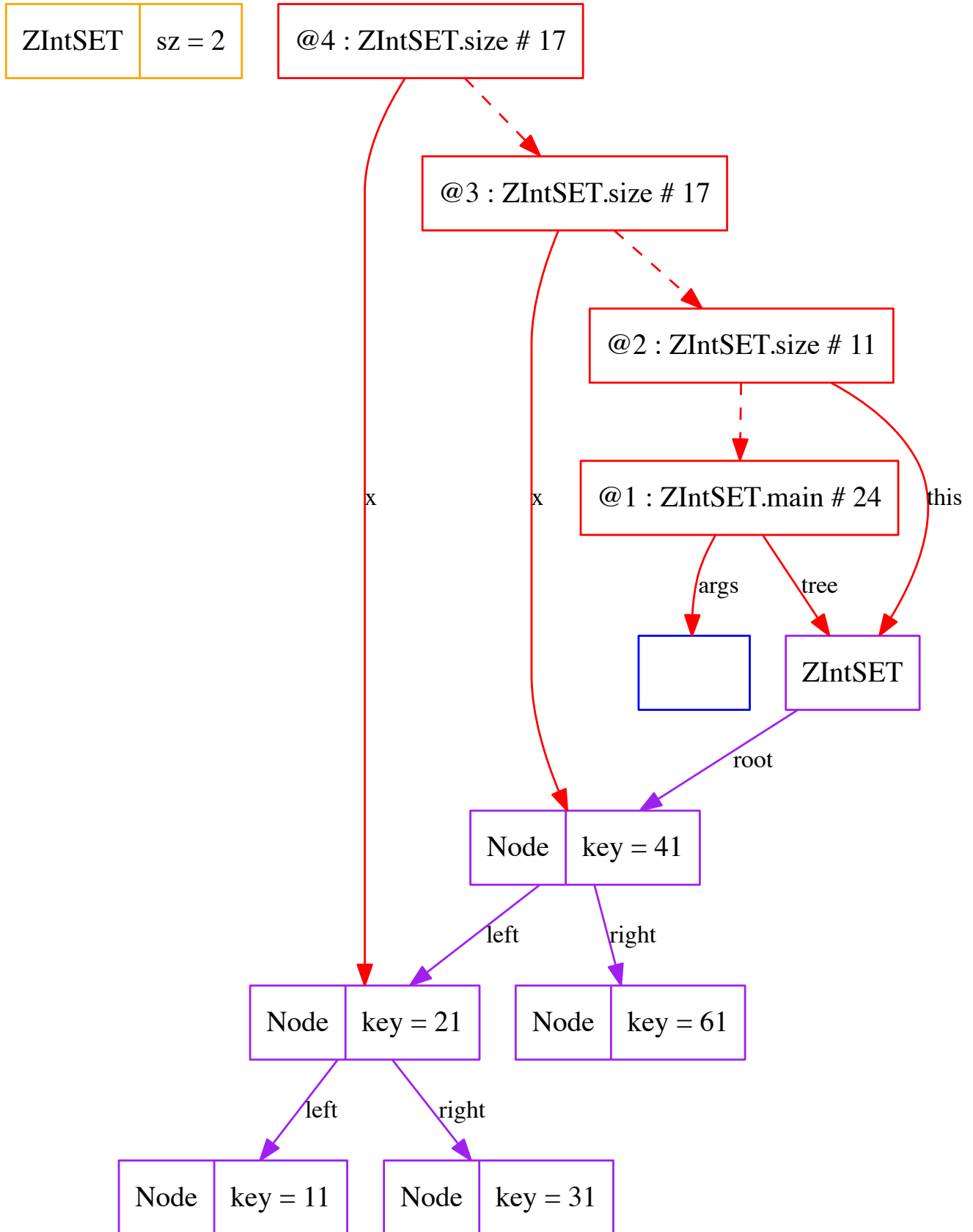

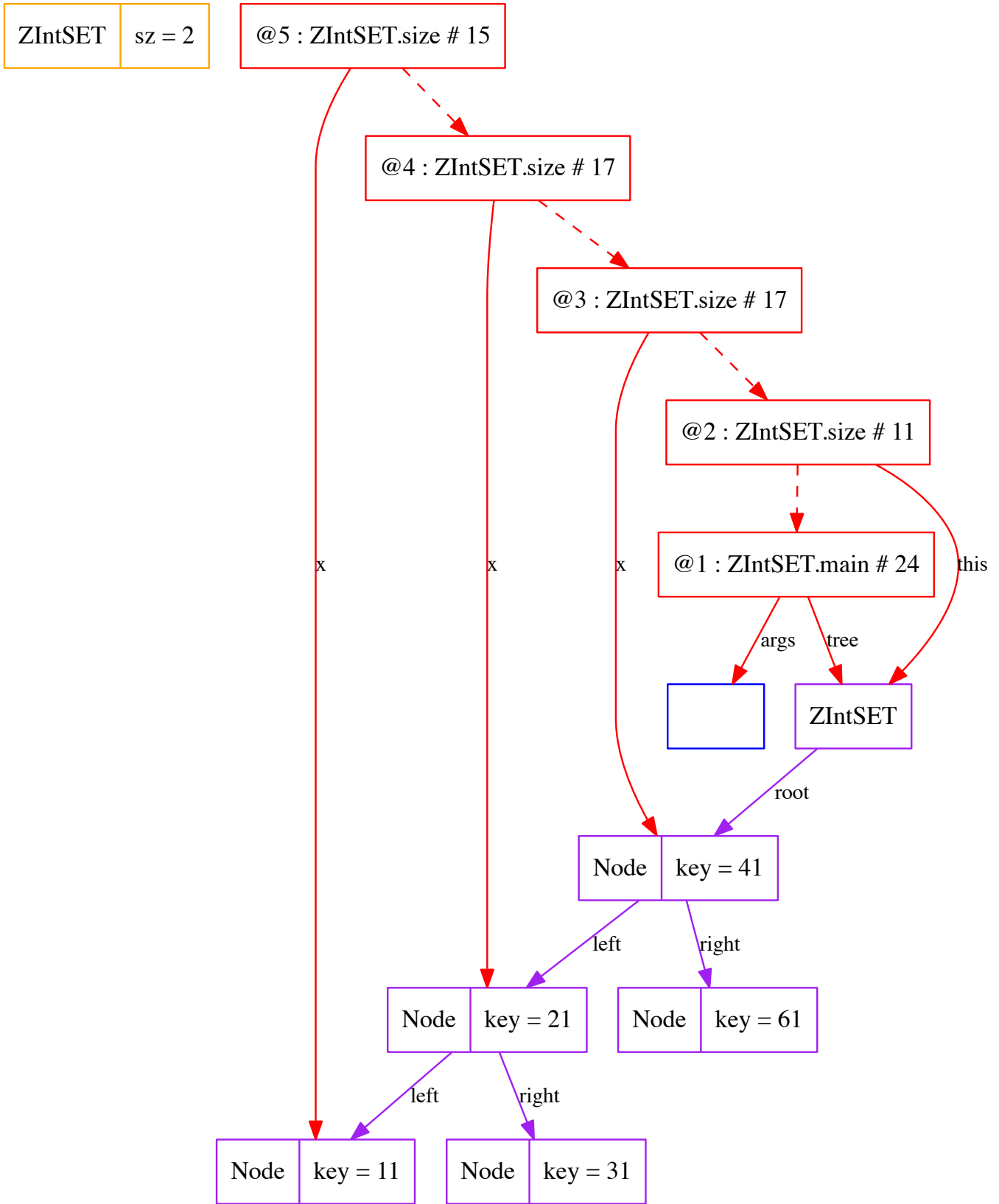

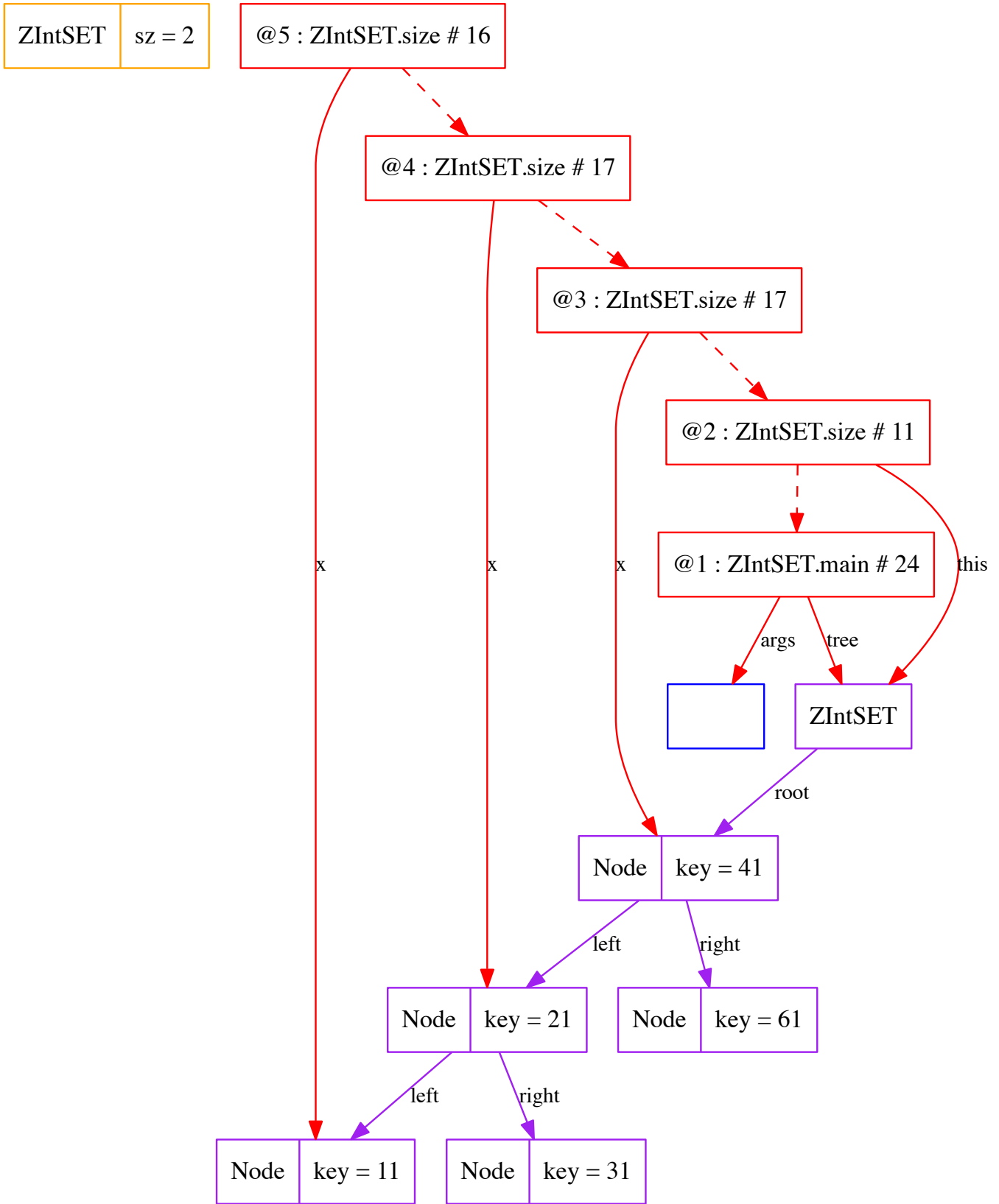

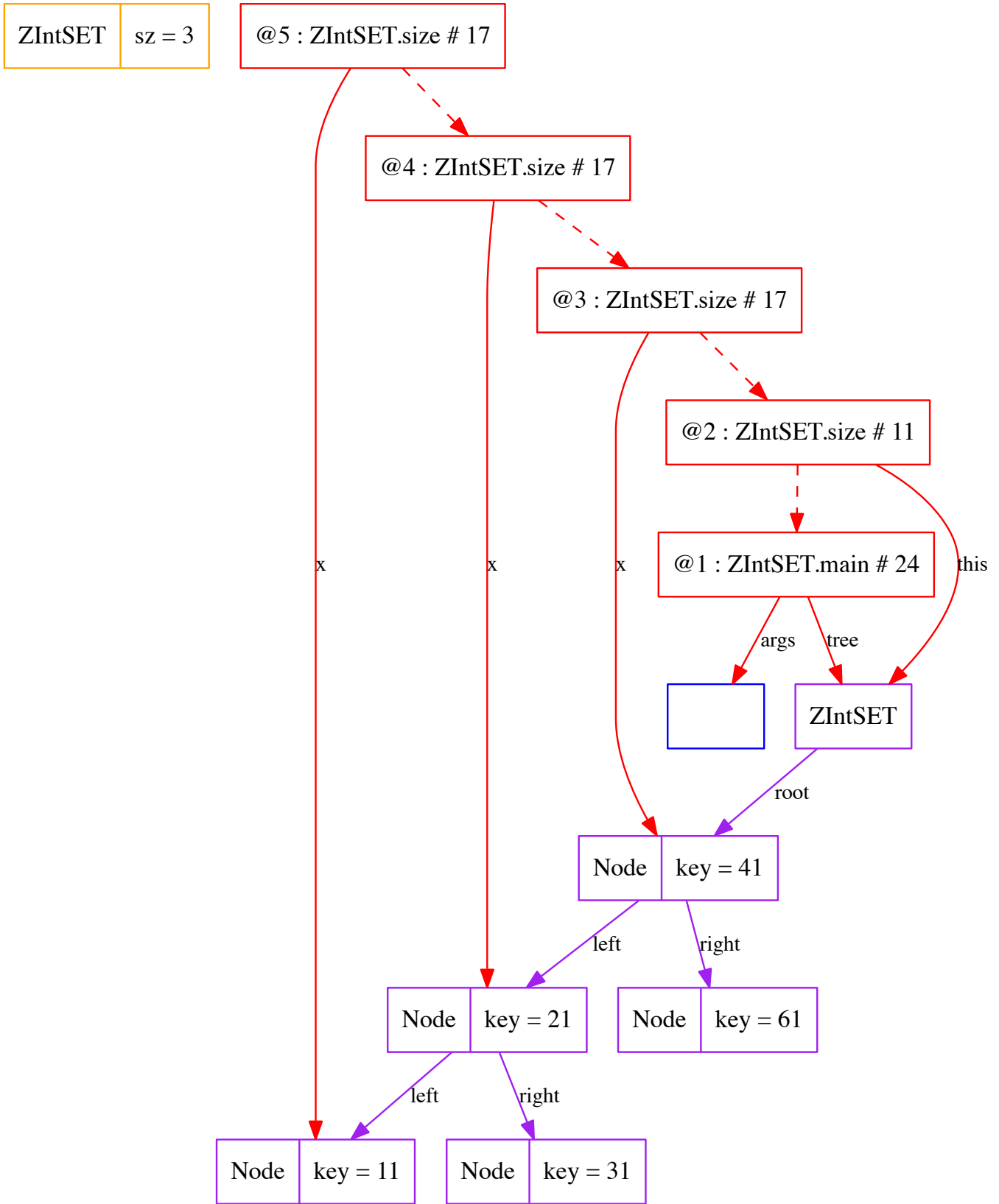

ZIntSET	sz = 3
---------	--------

@6 : ZIntSET.size # 15	x = null
------------------------	----------

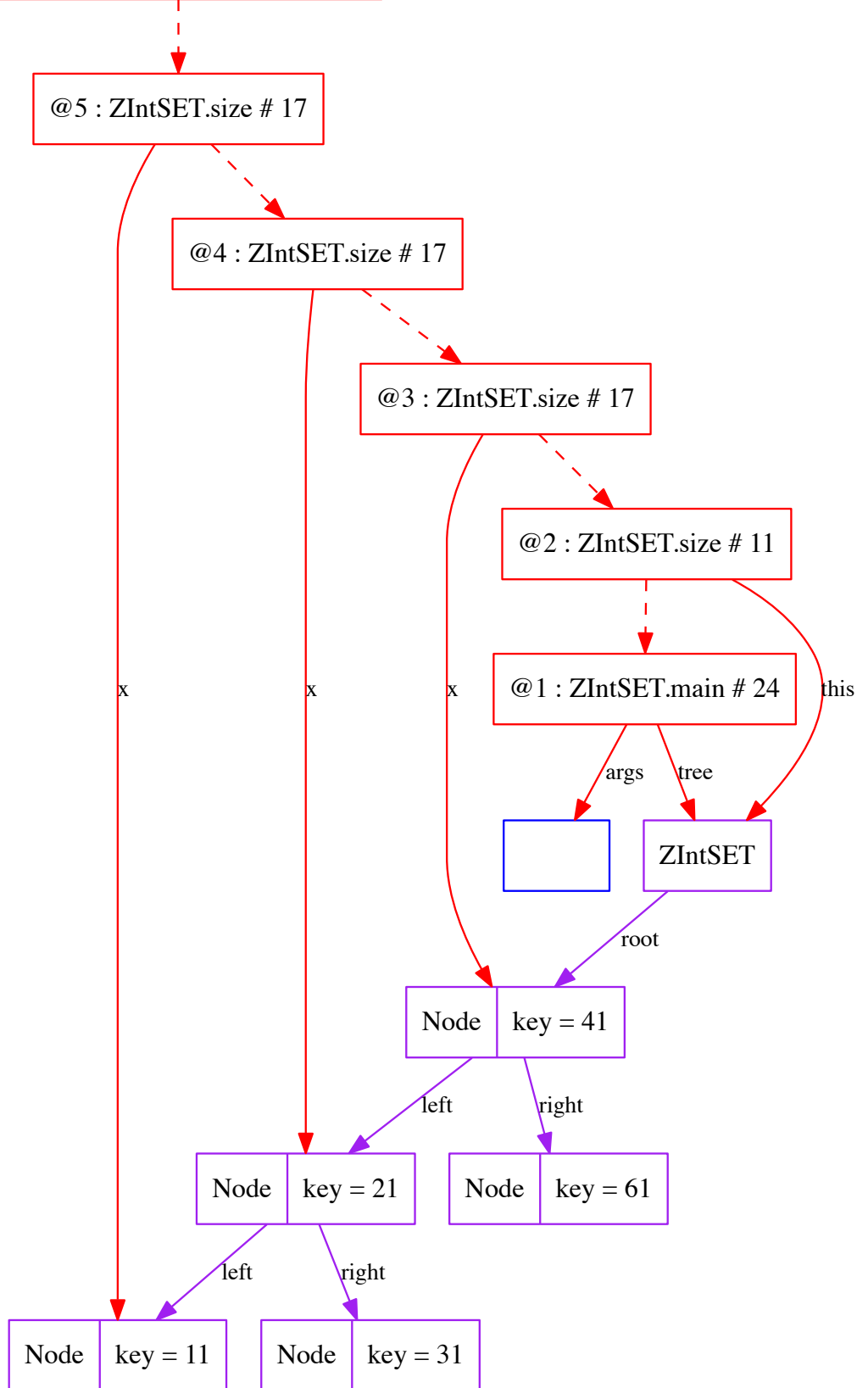

ZIntSET	sz = 3
---------	--------

@6 : returnValue = 3

@5 : ZIntSET.size # 17

@4 : ZIntSET.size # 17

@3 : ZIntSET.size # 17

@2 : ZIntSET.size # 11

@1 : ZIntSET.main # 24

ZIntSET

Node key = 41

Node key = 21

Node key = 61

Node key = 11

Node key = 31

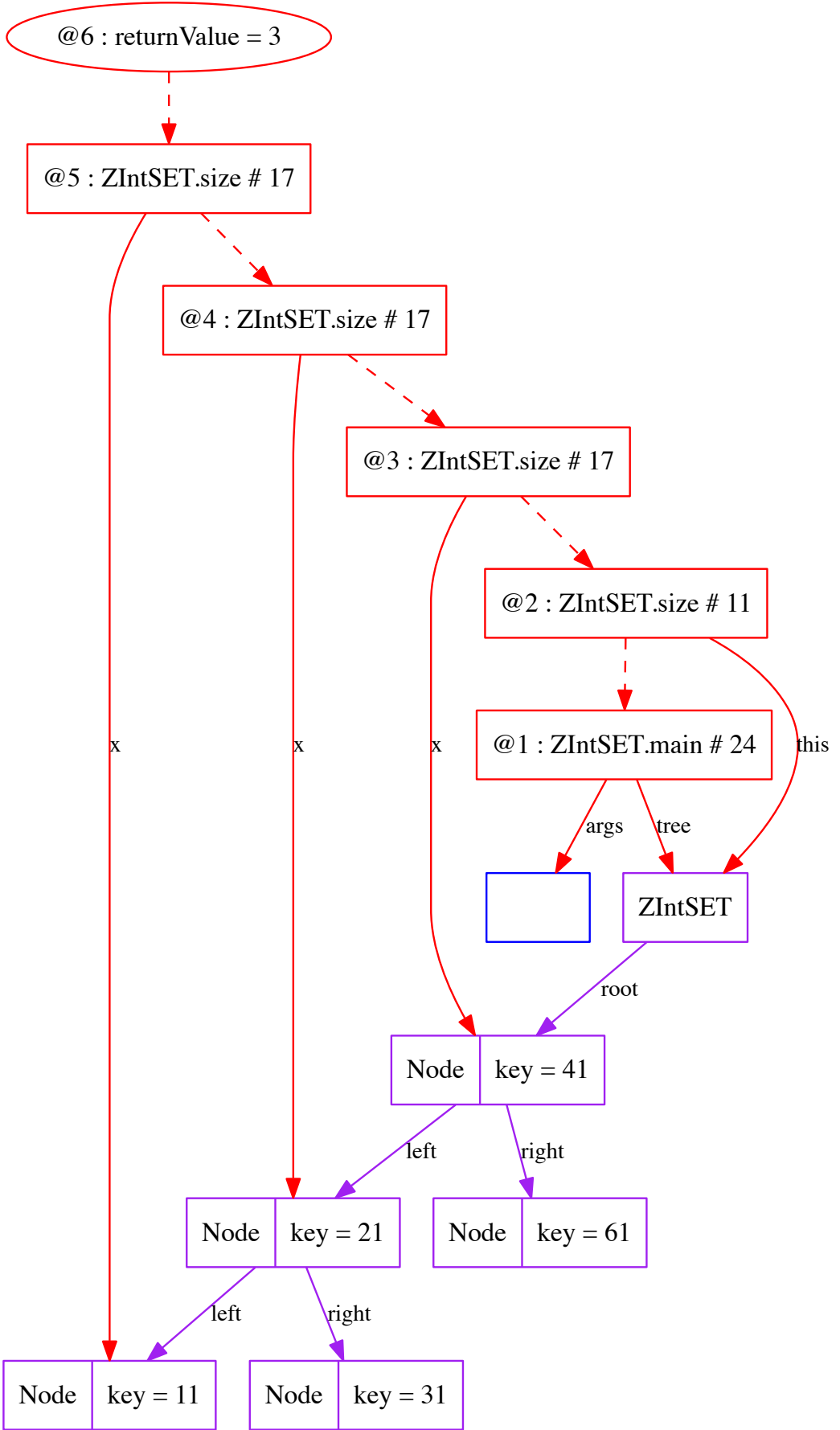

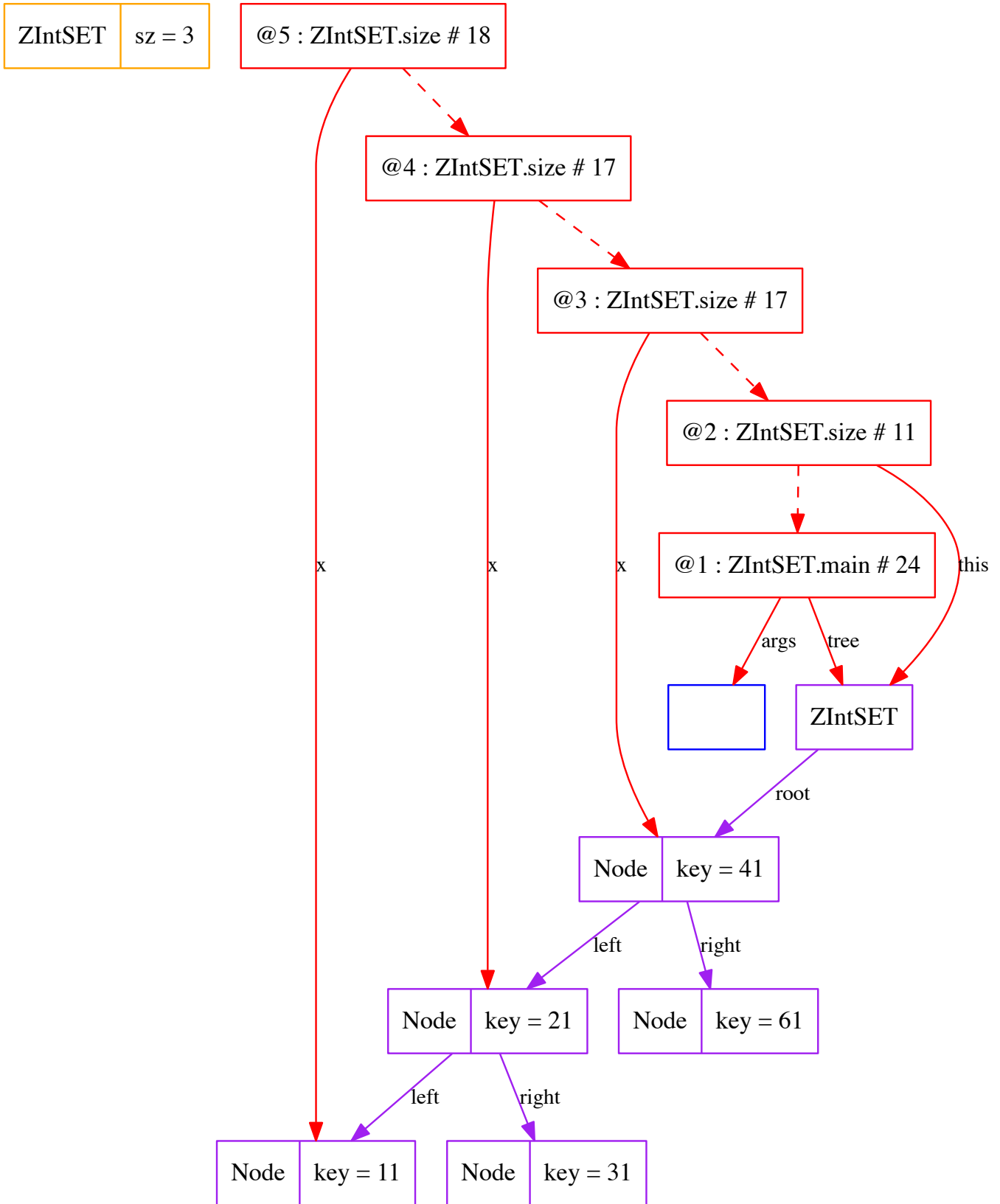

ZIntSET	sz = 3
---------	--------

@6 : ZIntSET.size # 15	x = null
------------------------	----------

@5 : ZIntSET.size # 18

@4 : ZIntSET.size # 17

@3 : ZIntSET.size # 17

@2 : ZIntSET.size # 11

@1 : ZIntSET.main # 24

--

ZIntSET

Node	key = 41
------	----------

Node	key = 21
------	----------

Node	key = 61
------	----------

Node	key = 11
------	----------

Node	key = 31
------	----------

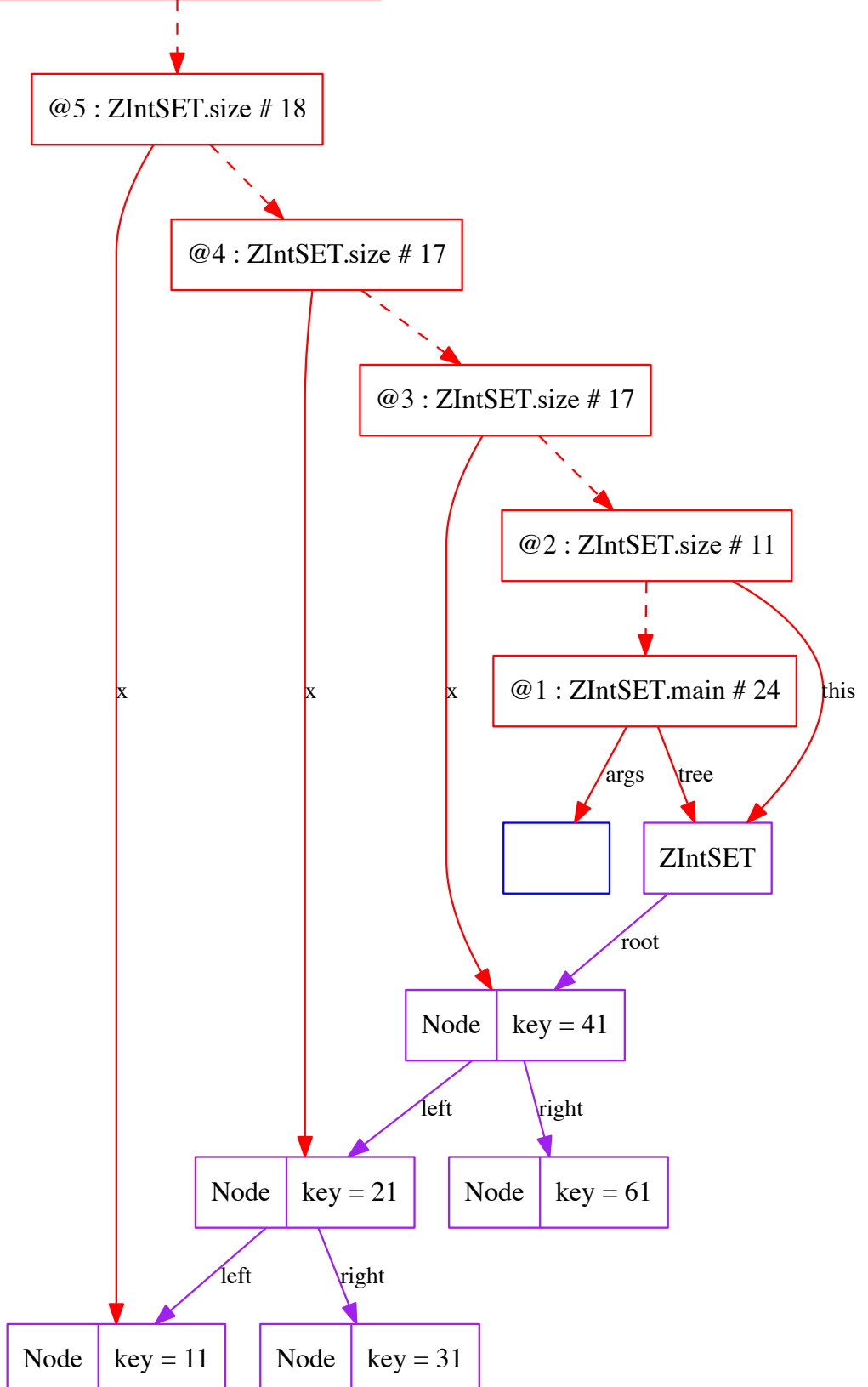

ZIntSET	sz = 3
---------	--------

@6 : returnValue = 3

@5 : ZIntSET.size # 18

@4 : ZIntSET.size # 17

@3 : ZIntSET.size # 17

@2 : ZIntSET.size # 11

@1 : ZIntSET.main # 24

ZIntSET

Node key = 41

Node key = 21

Node key = 61

Node key = 11

Node key = 31

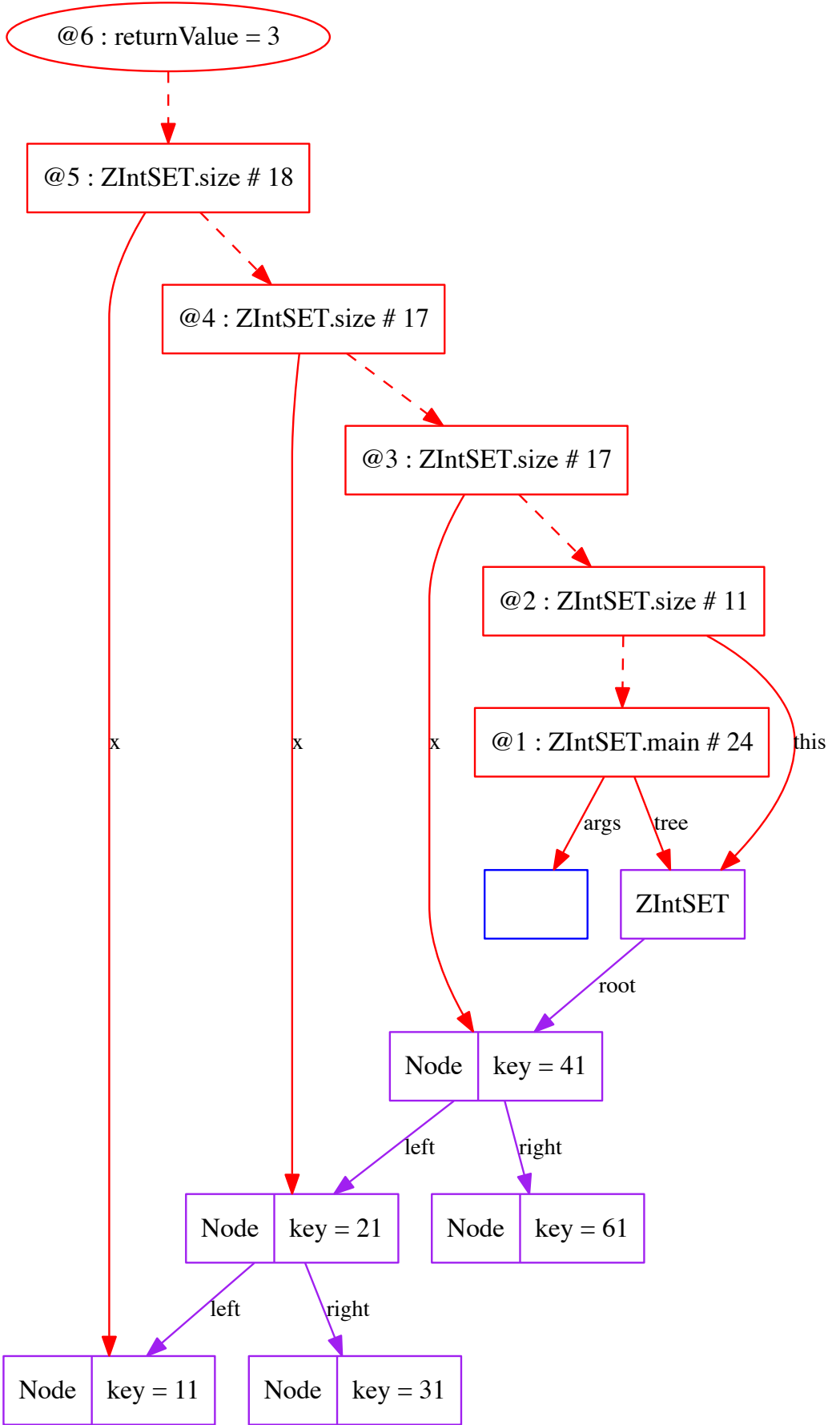

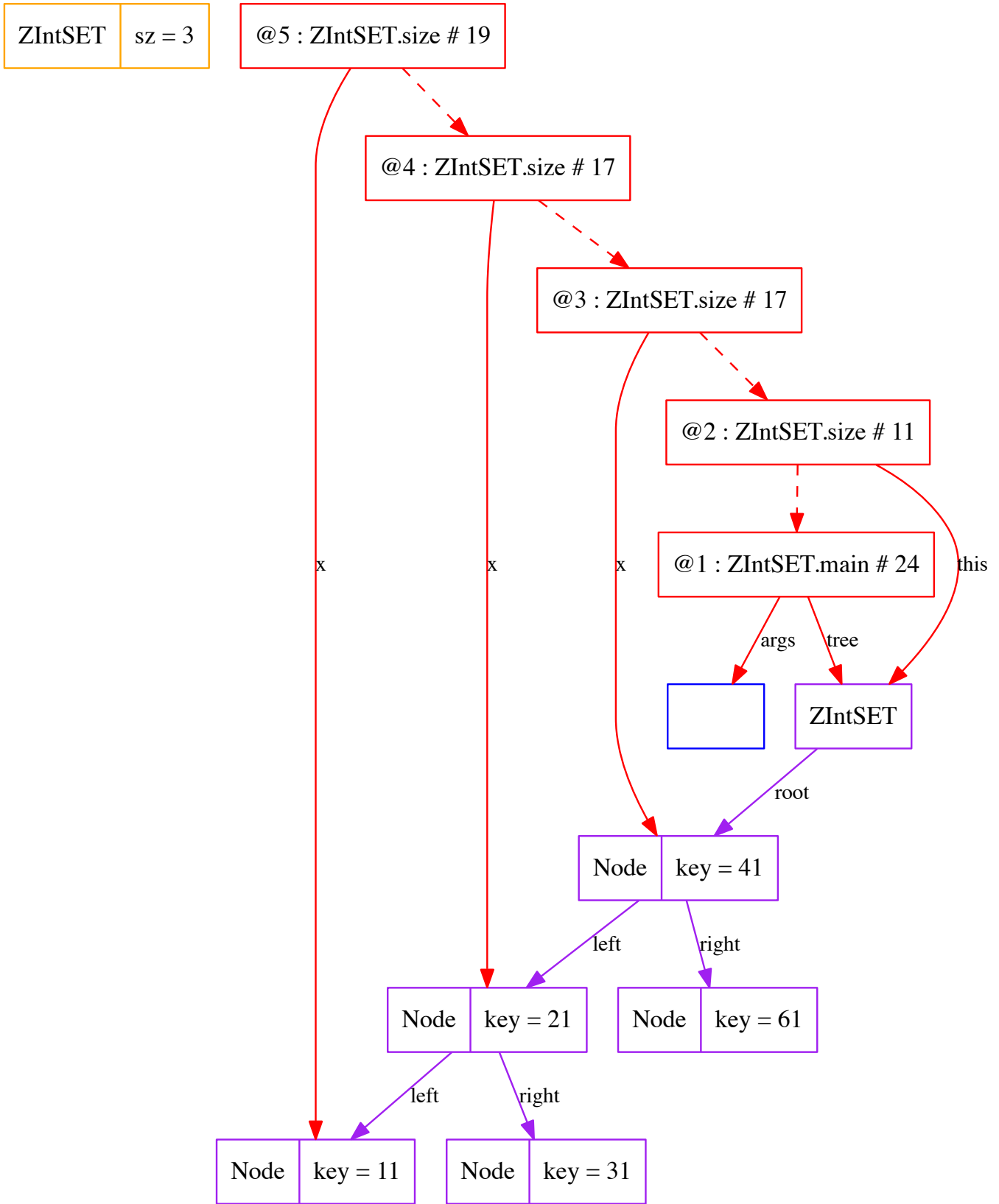

ZIntSET	sz = 3
---------	--------

@5 : returnValue = 3

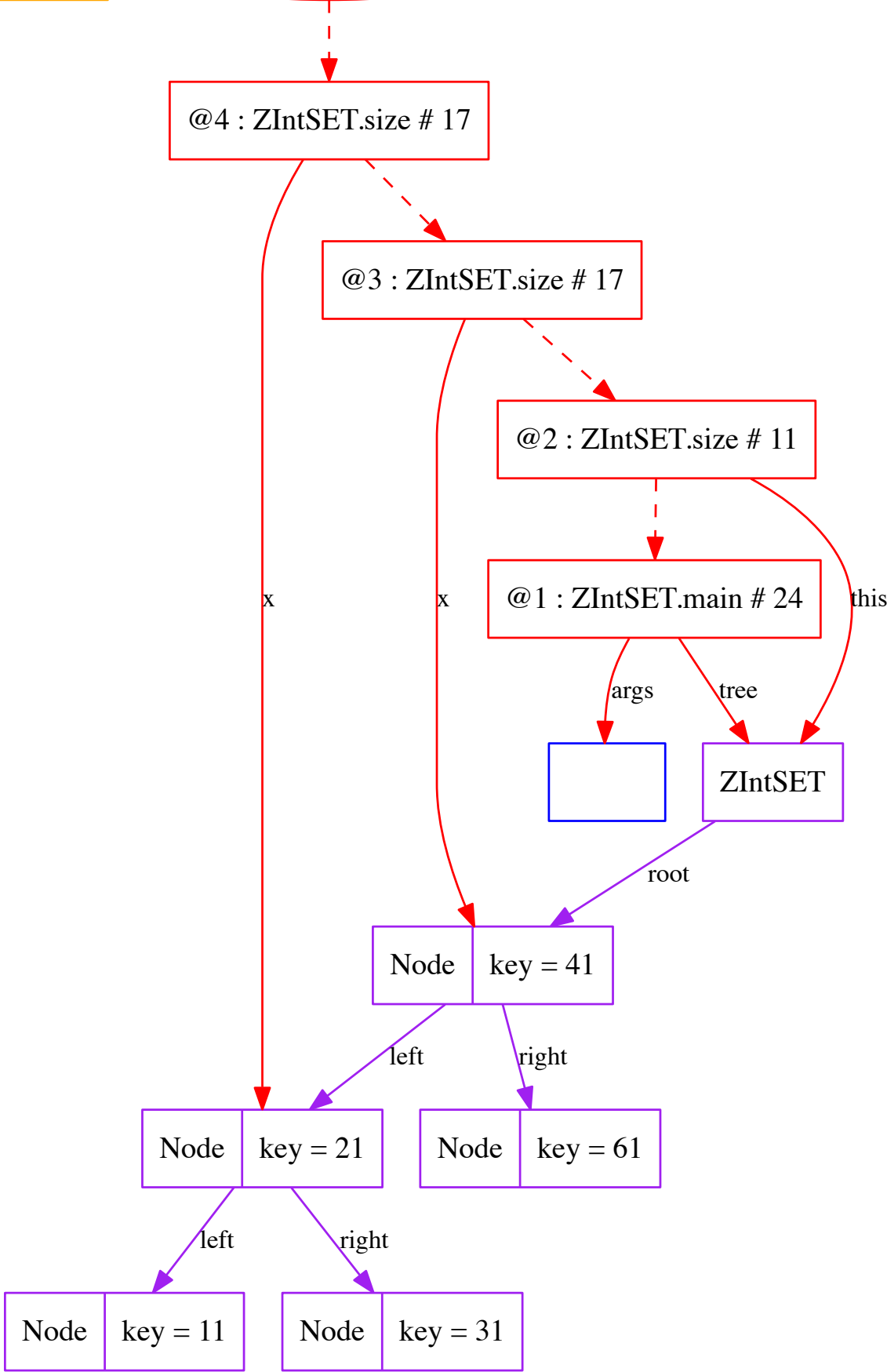

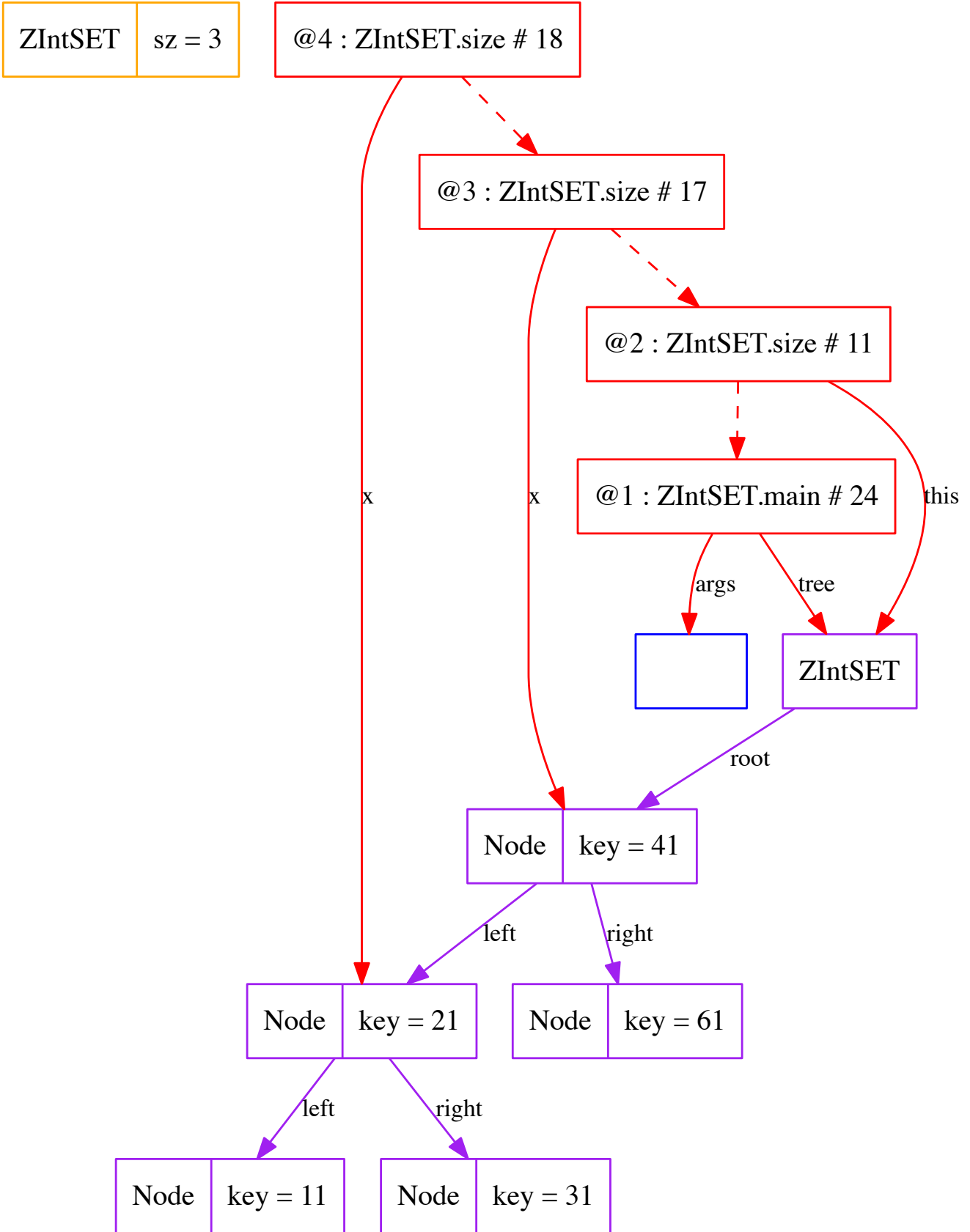

ZIntSET	sz = 3
---------	--------

@5 : ZIntSET.size # 15

@4 : ZIntSET.size # 18

@3 : ZIntSET.size # 17

@2 : ZIntSET.size # 11

@1 : ZIntSET.main # 24

ZIntSET

Node	key = 41
------	----------

Node	key = 21
------	----------

Node	key = 61
------	----------

Node	key = 31
------	----------

Node	key = 11
------	----------

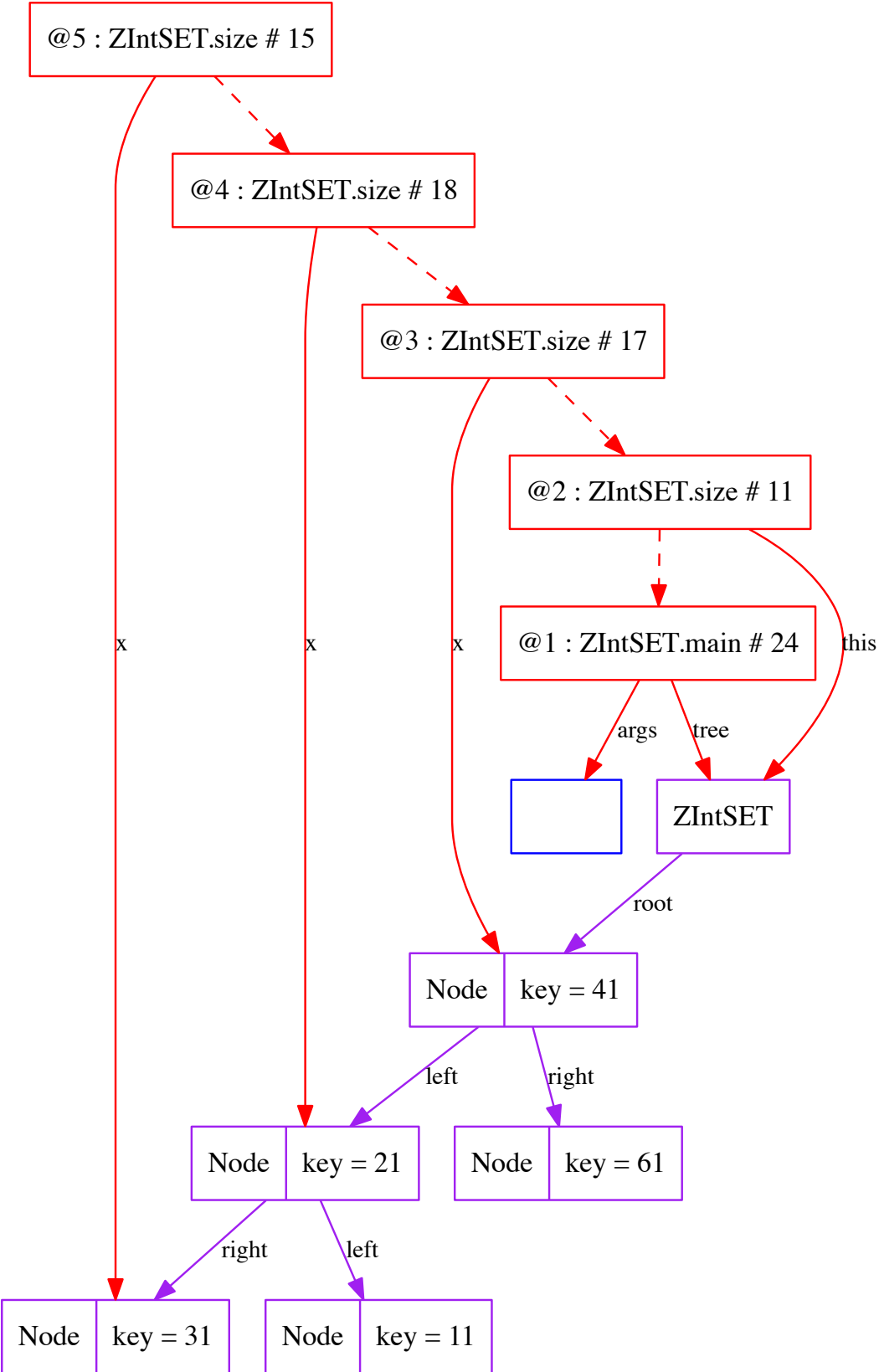

ZIntSET	sz = 3
---------	--------

@5 : ZIntSET.size # 16

@4 : ZIntSET.size # 18

@3 : ZIntSET.size # 17

@2 : ZIntSET.size # 11

@1 : ZIntSET.main # 24

ZIntSET

Node	key = 41
------	----------

Node	key = 21
------	----------

Node	key = 61
------	----------

Node	key = 31
------	----------

Node	key = 11
------	----------

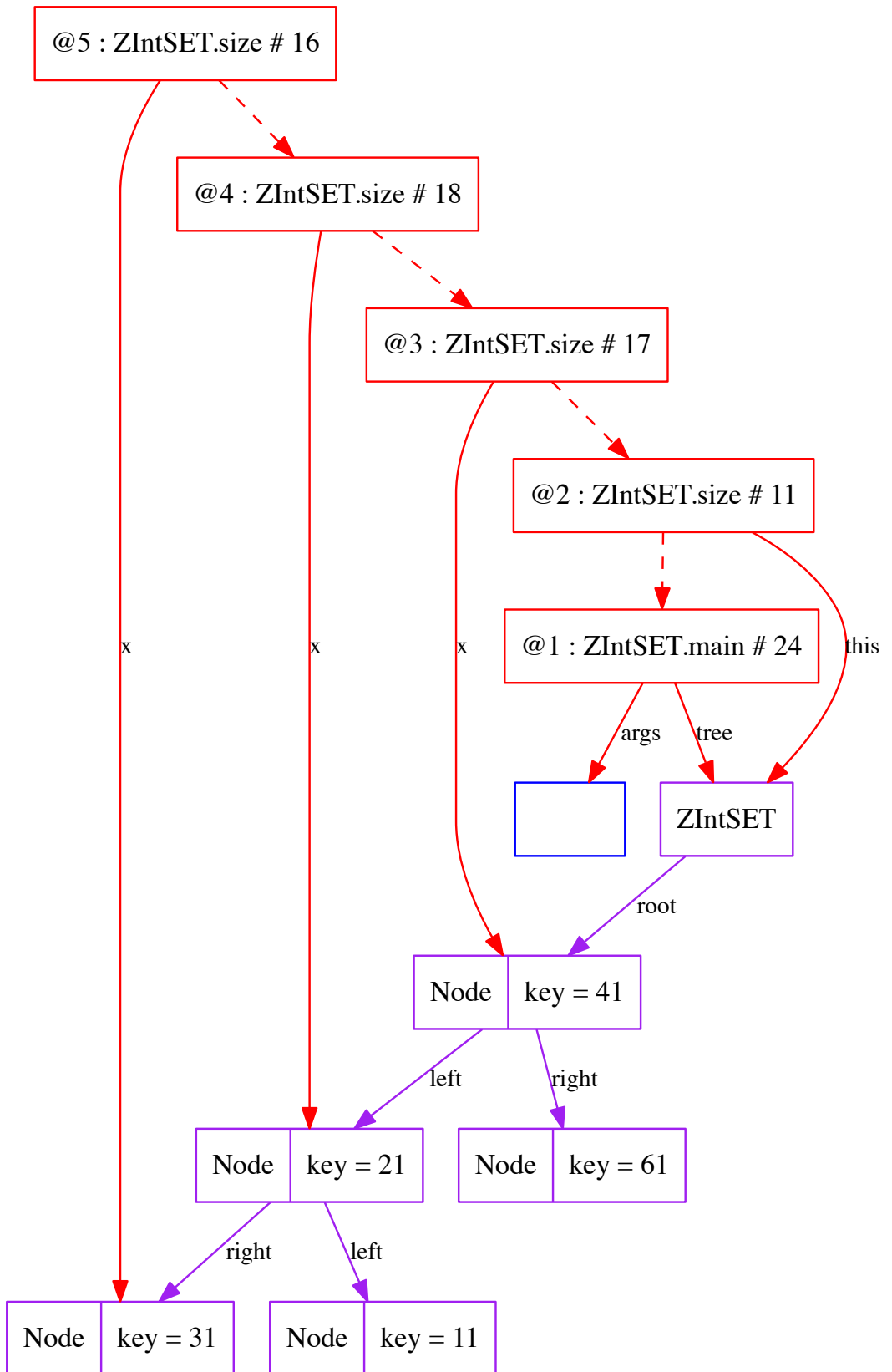

ZIntSET	sz = 4
---------	--------

@5 : ZIntSET.size # 17

@4 : ZIntSET.size # 18

@3 : ZIntSET.size # 17

@2 : ZIntSET.size # 11

@1 : ZIntSET.main # 24

ZIntSET

Node	key = 41
------	----------

Node	key = 21
------	----------

Node	key = 61
------	----------

Node	key = 31
------	----------

Node	key = 11
------	----------

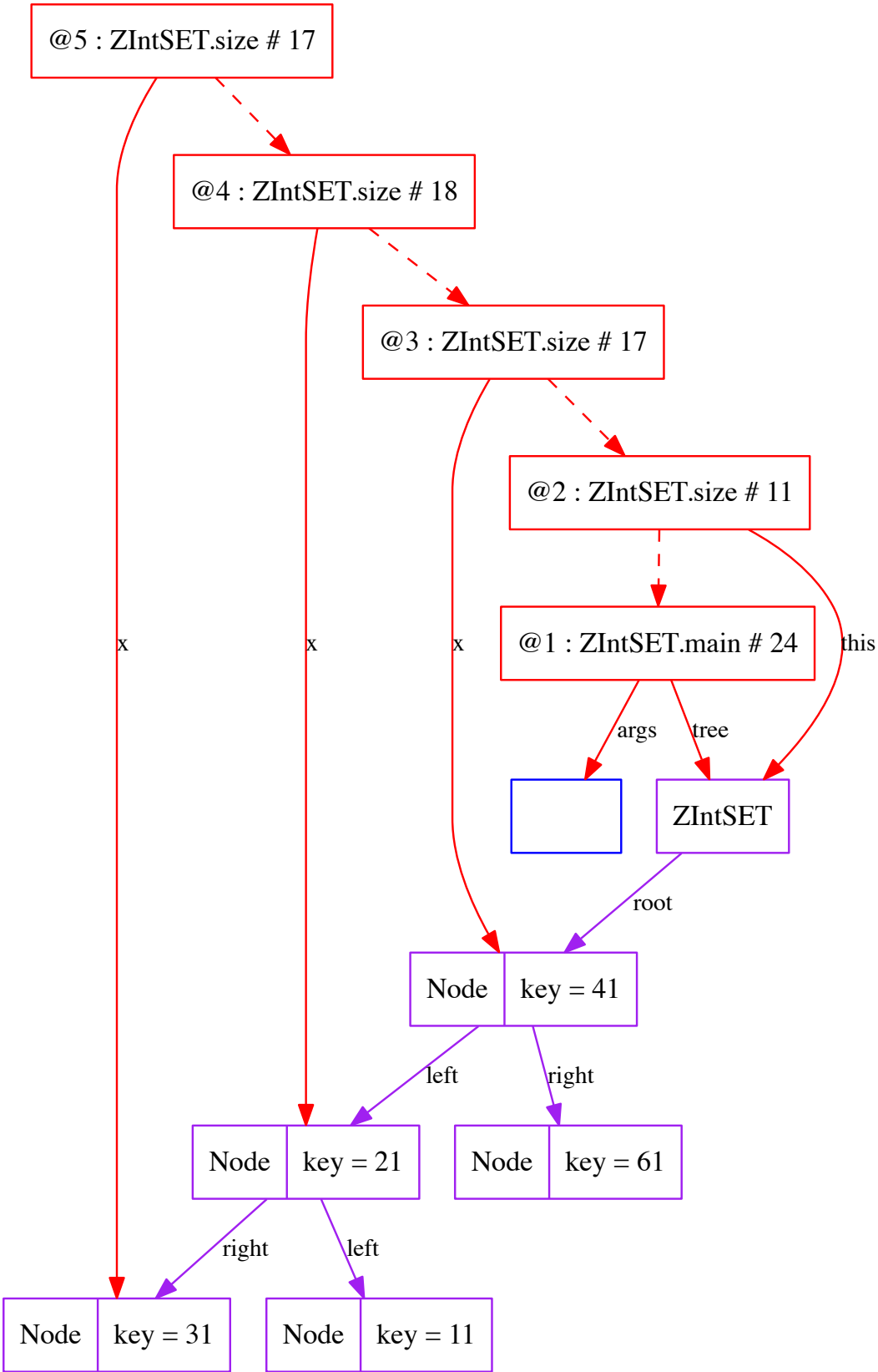

ZIntSET	sz = 4
---------	--------

@6 : ZIntSET.size # 15	x = null
------------------------	----------

@5 : ZIntSET.size # 17

@4 : ZIntSET.size # 18

@3 : ZIntSET.size # 17

@2 : ZIntSET.size # 11

@1 : ZIntSET.main # 24

--

ZIntSET

Node	key = 41
------	----------

Node	key = 21
------	----------

Node	key = 61
------	----------

Node	key = 31
------	----------

Node	key = 11
------	----------

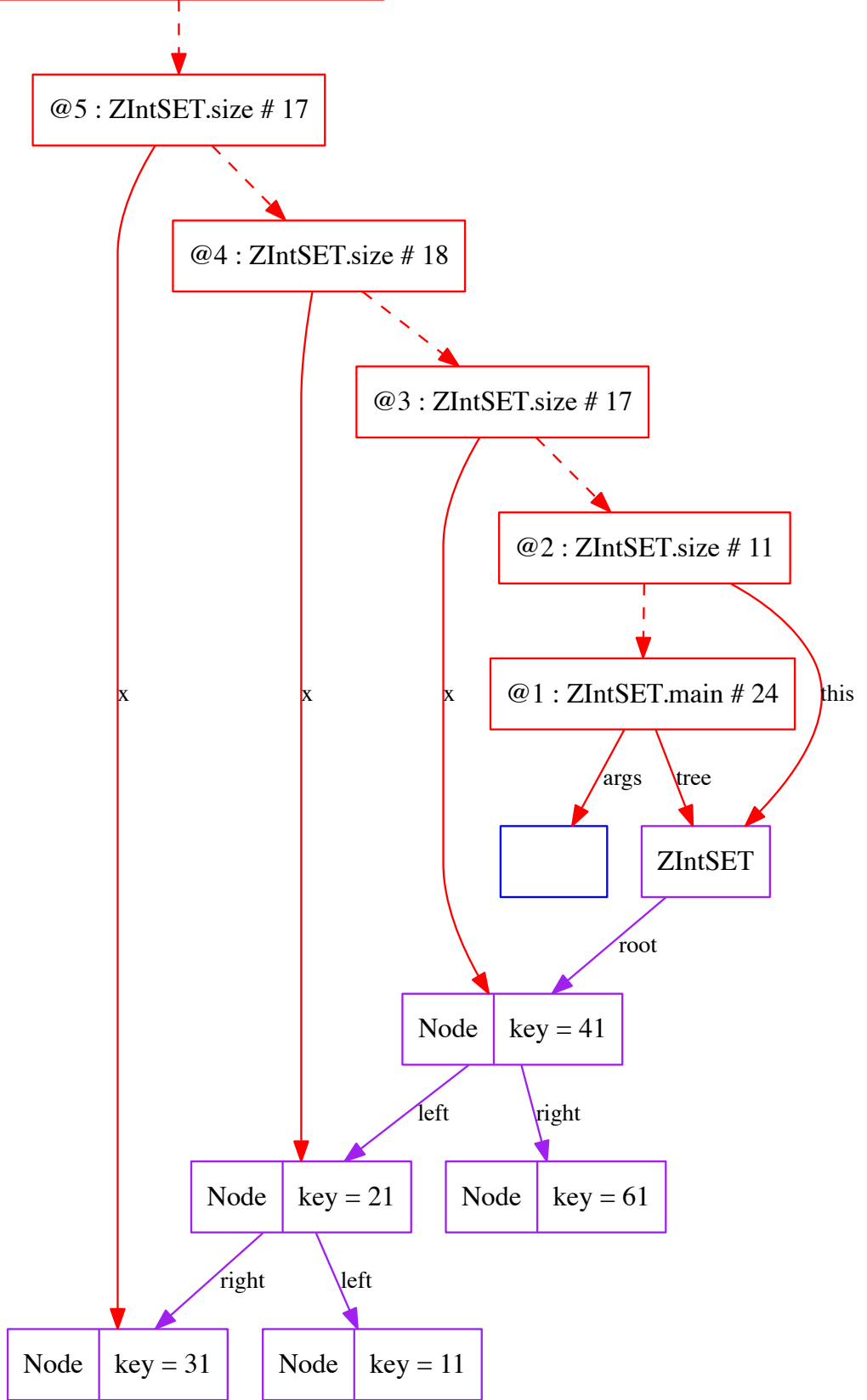

ZIntSET	sz = 4
---------	--------

@6 : returnValue = 4

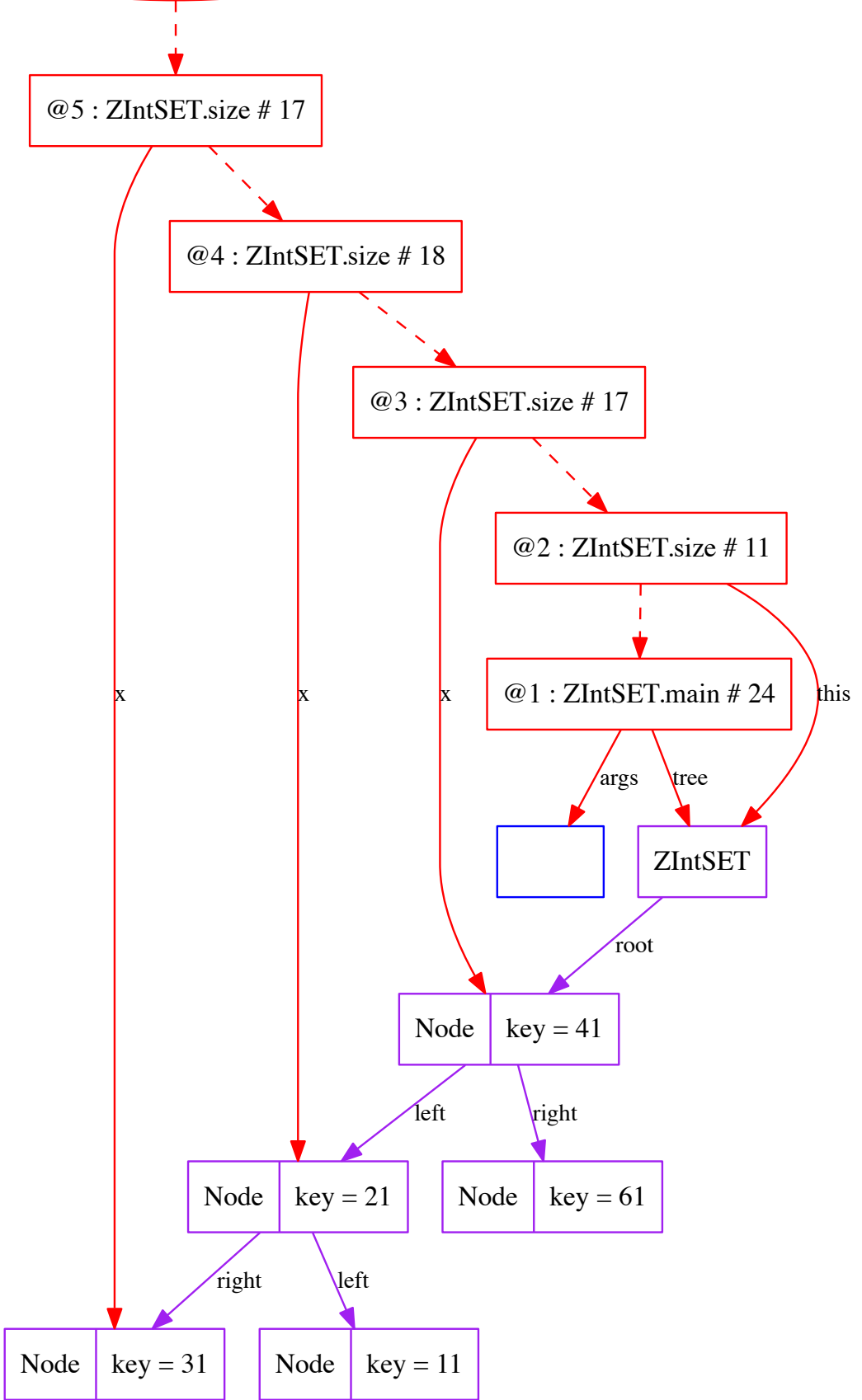

ZIntSET	sz = 4
---------	--------

@5 : ZIntSET.size # 18

@4 : ZIntSET.size # 18

@3 : ZIntSET.size # 17

@2 : ZIntSET.size # 11

@1 : ZIntSET.main # 24

ZIntSET

Node	key = 41
------	----------

Node	key = 21
------	----------

Node	key = 61
------	----------

Node	key = 31
------	----------

Node	key = 11
------	----------

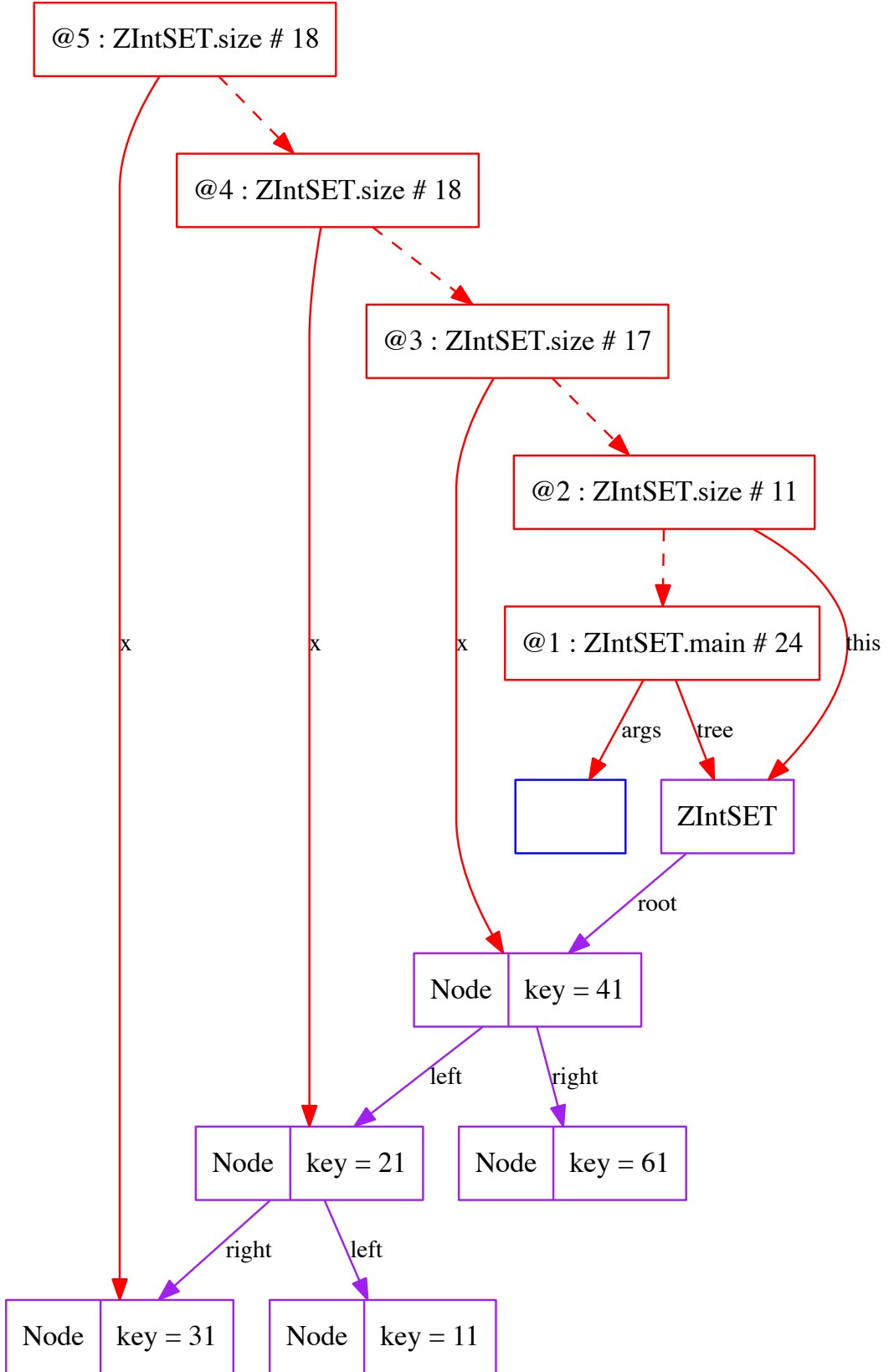

ZIntSET	sz = 4
---------	--------

@6 : ZIntSET.size # 15	x = null
------------------------	----------

@5 : ZIntSET.size # 18

@4 : ZIntSET.size # 18

@3 : ZIntSET.size # 17

@2 : ZIntSET.size # 11

@1 : ZIntSET.main # 24

--

ZIntSET

Node	key = 41
------	----------

Node	key = 21
------	----------

Node	key = 61
------	----------

Node	key = 31
------	----------

Node	key = 11
------	----------

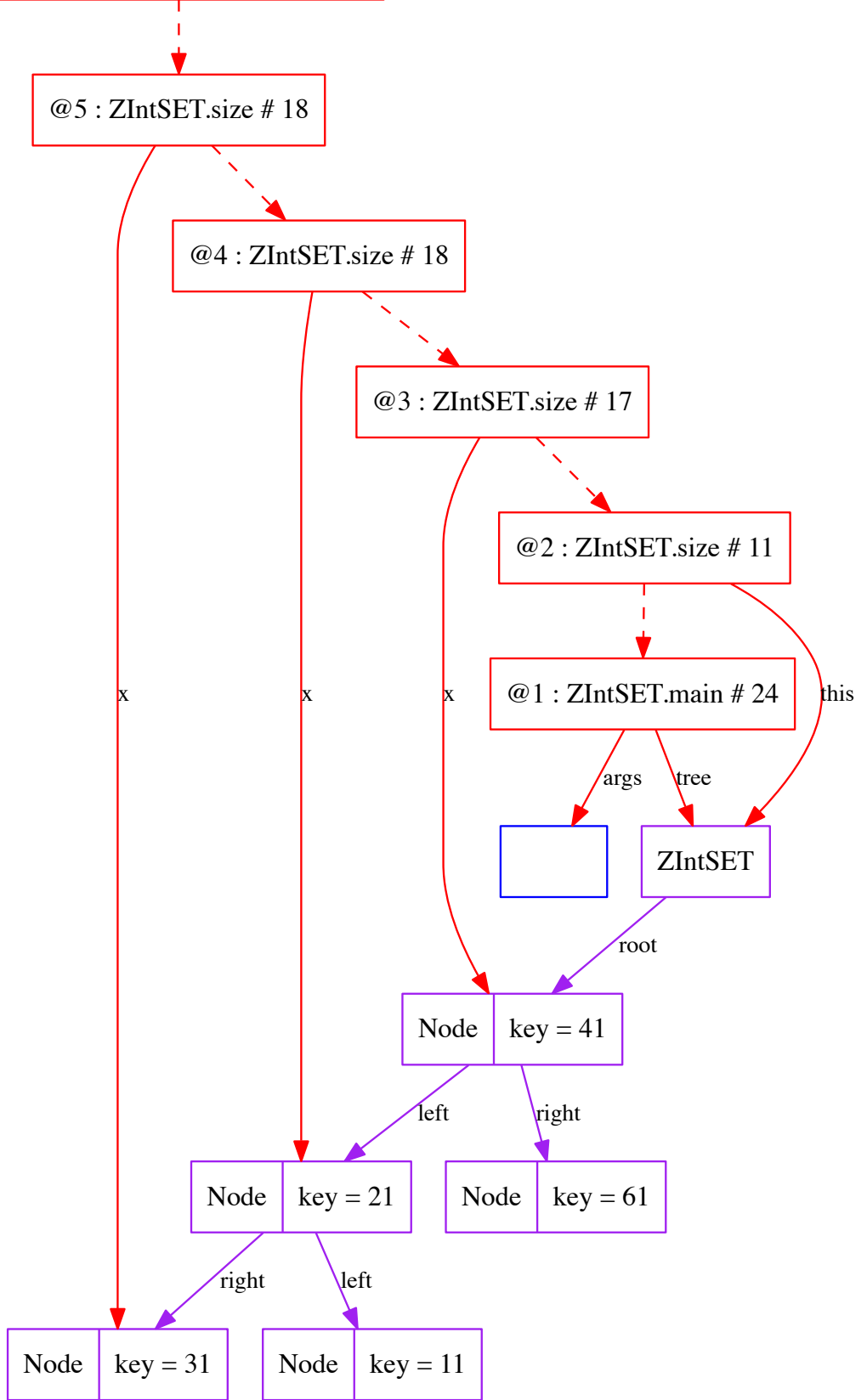

ZIntSET	sz = 4
---------	--------

@6 : returnValue = 4

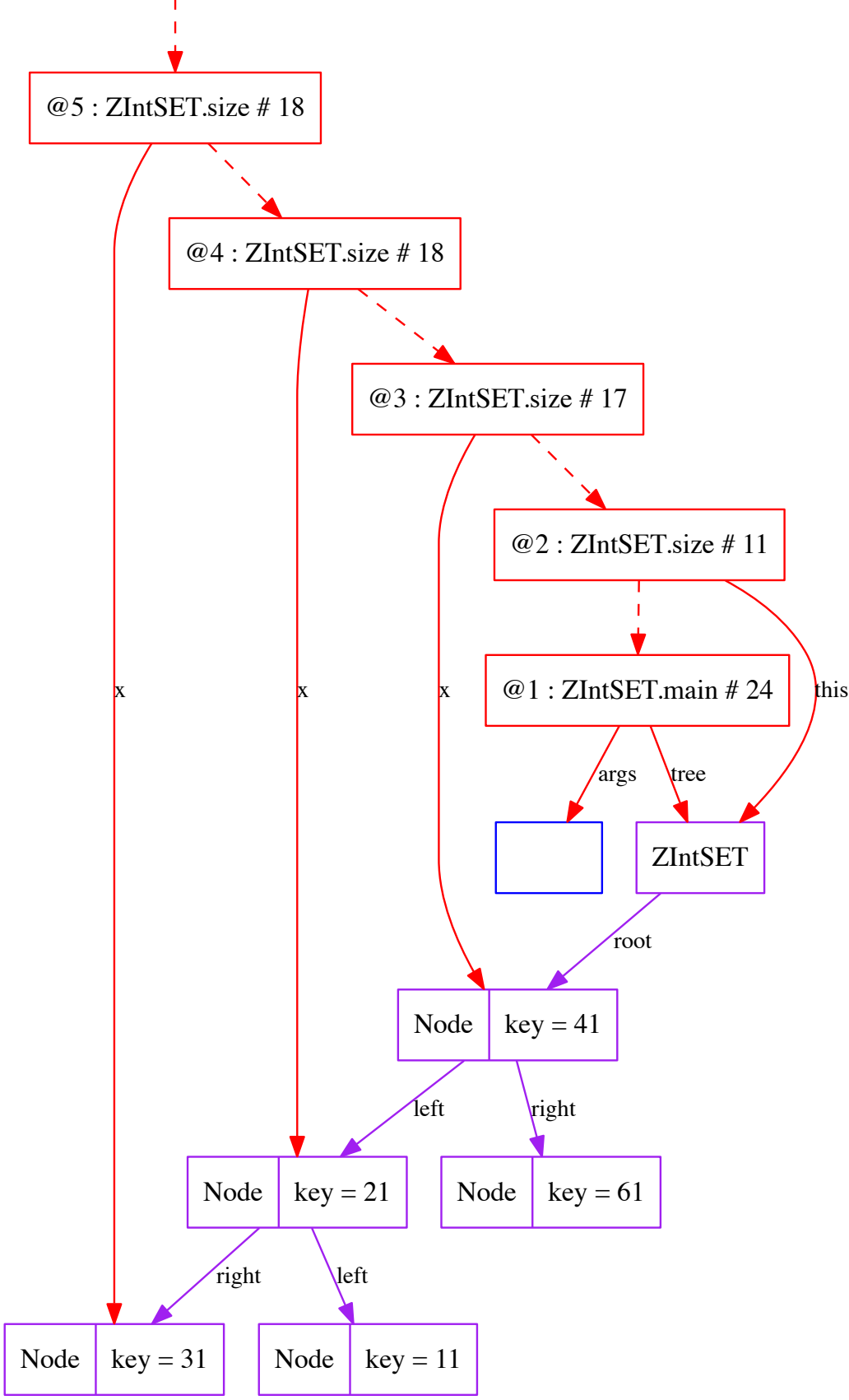

ZIntSET	sz = 4
---------	--------

@5 : ZIntSET.size # 19

@4 : ZIntSET.size # 18

@3 : ZIntSET.size # 17

@2 : ZIntSET.size # 11

@1 : ZIntSET.main # 24

ZIntSET

Node	key = 41
------	----------

Node	key = 21
------	----------

Node	key = 61
------	----------

Node	key = 31
------	----------

Node	key = 11
------	----------

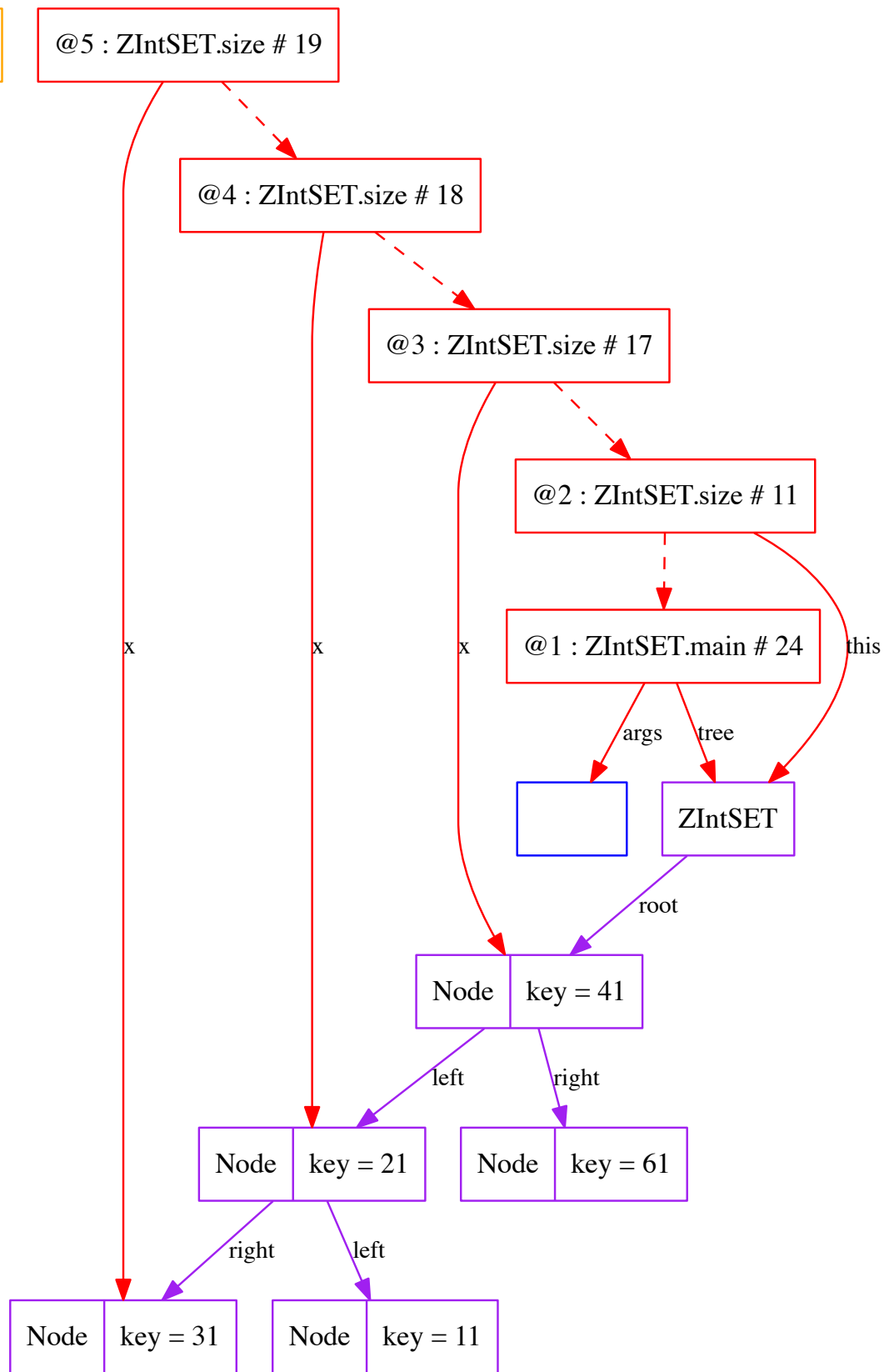

ZIntSET	sz = 4
---------	--------

@5 : returnValue = 4

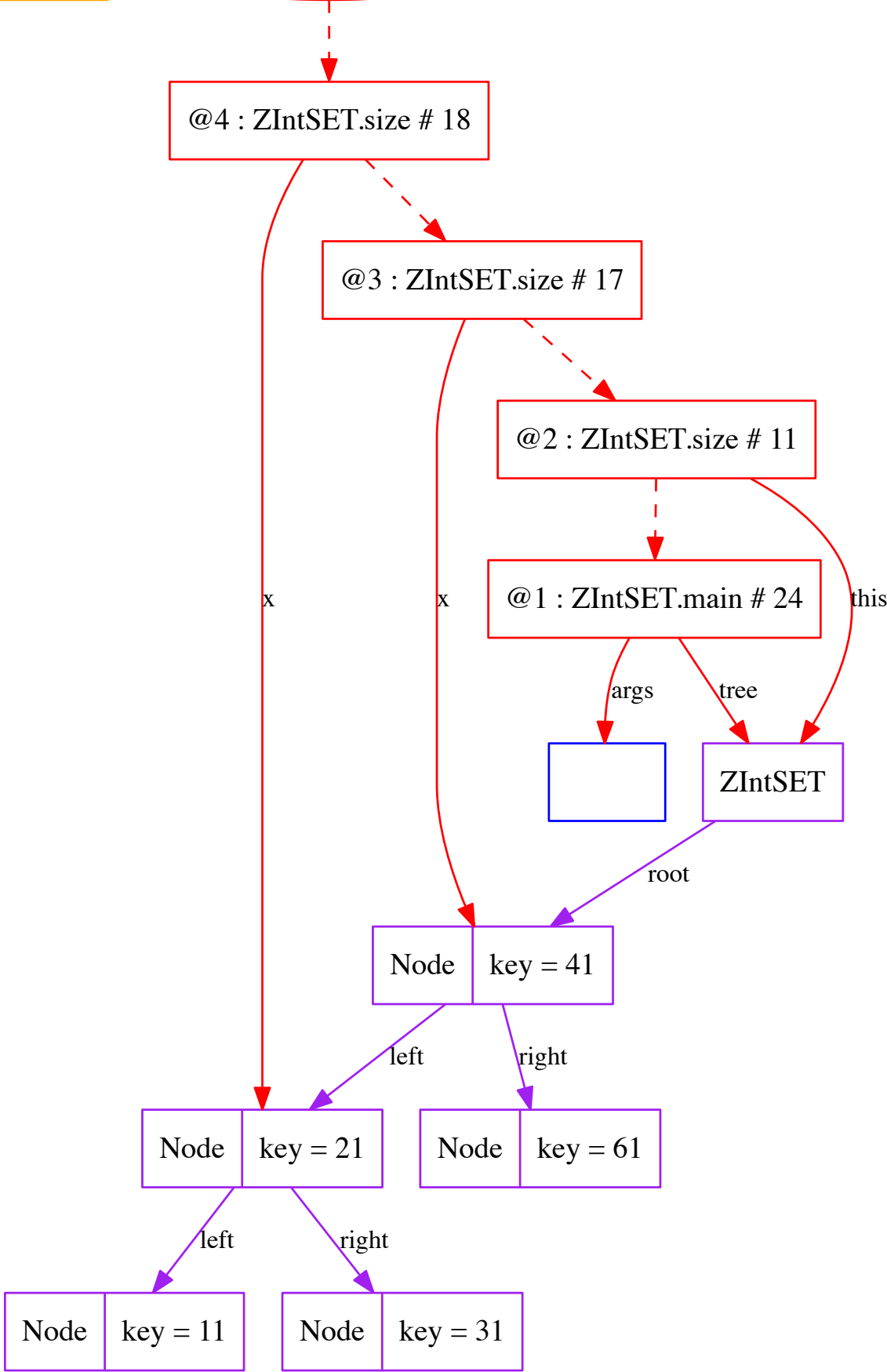

ZIntSET	sz = 4
---------	--------

@4 : ZIntSET.size # 19

@3 : ZIntSET.size # 17

@2 : ZIntSET.size # 11

@1 : ZIntSET.main # 24

--

ZIntSET

Node	key = 41
------	----------

Node	key = 21
------	----------

Node	key = 61
------	----------

Node	key = 11
------	----------

Node	key = 31
------	----------

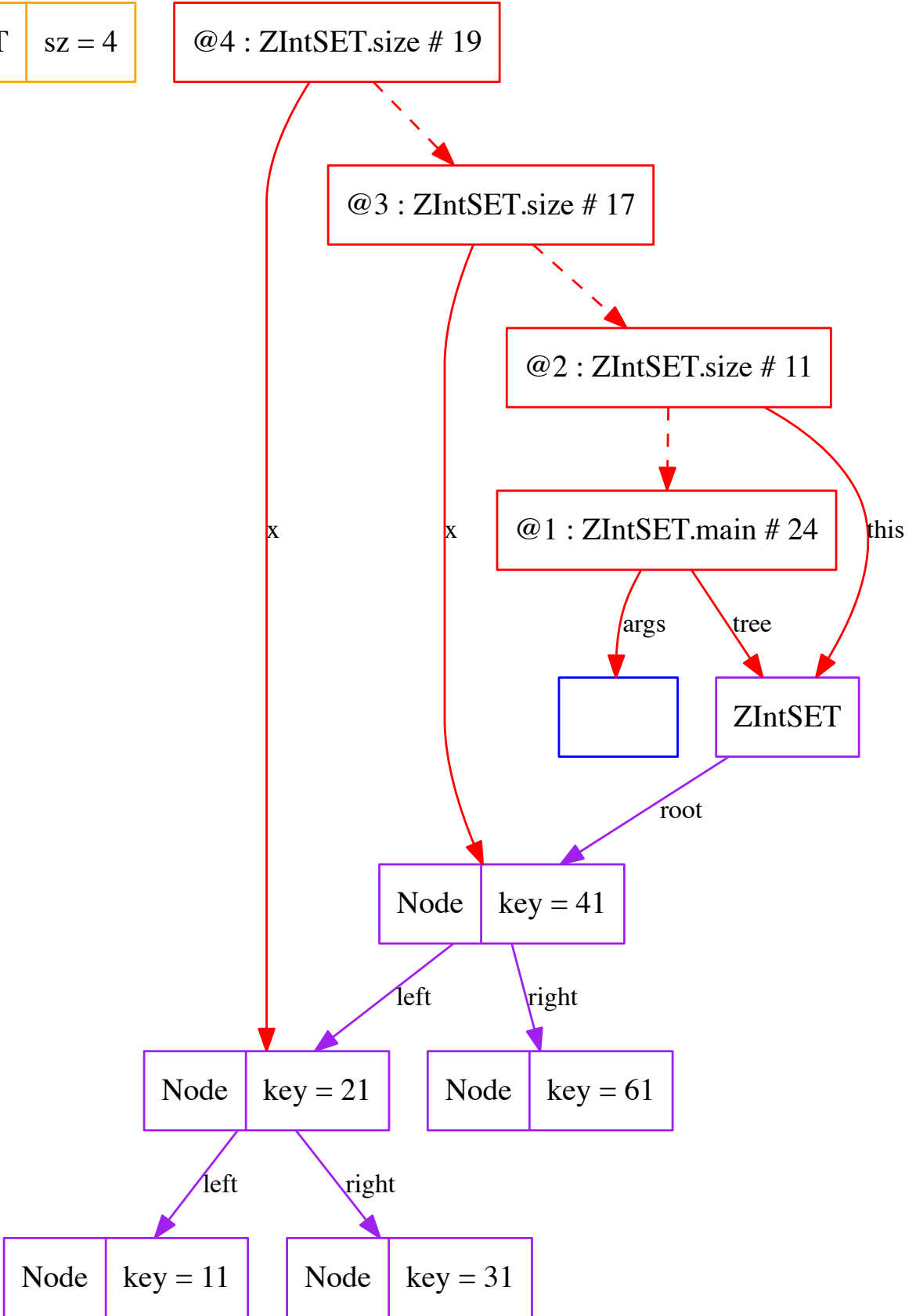

ZIntSET	sz = 4
---------	--------

@4 : returnValue = 4

@3 : ZIntSET.size # 17

@2 : ZIntSET.size # 11

@1 : ZIntSET.main # 24

ZIntSET

Node key = 41

Node key = 21

Node key = 61

Node key = 11

Node key = 31

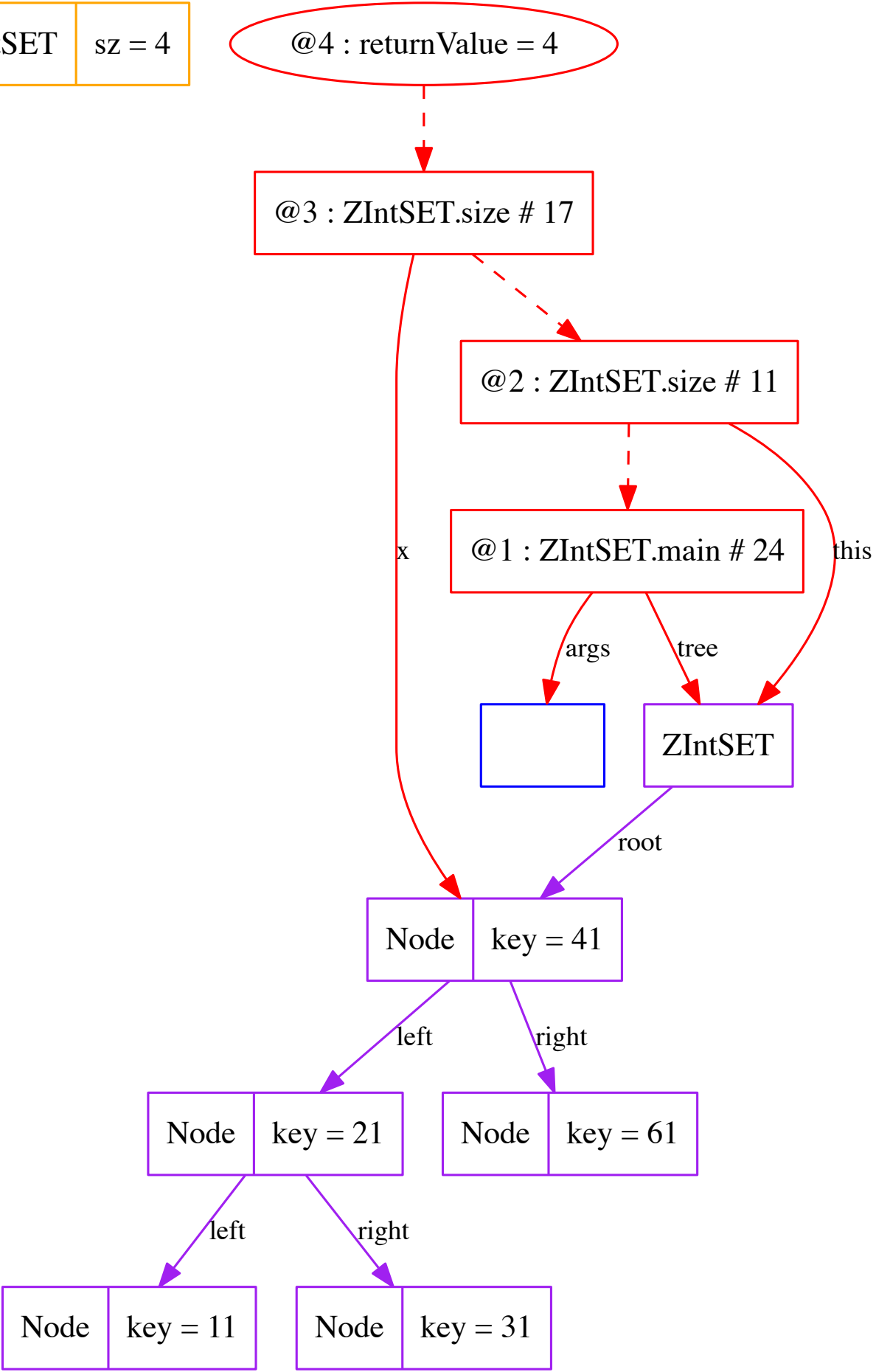

ZIntSET	sz = 4
---------	--------

@3 : ZIntSET.size # 18

@2 : ZIntSET.size # 11

@1 : ZIntSET.main # 24

ZIntSET

Node key = 41

Node key = 21

Node key = 61

Node key = 11

Node key = 31

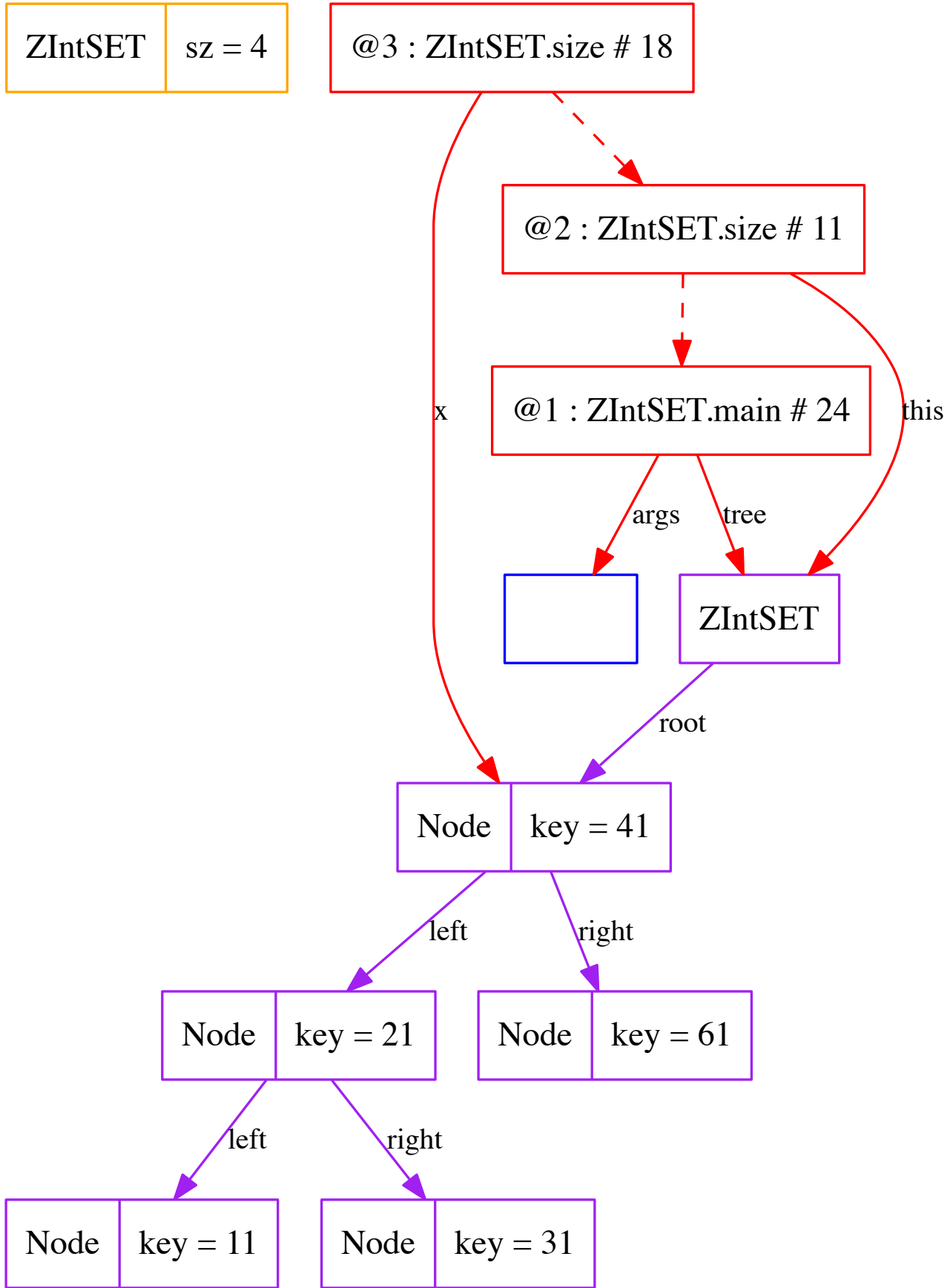

ZIntSET	sz = 4
---------	--------

@4 : ZIntSET.size # 15

@3 : ZIntSET.size # 18

@2 : ZIntSET.size # 11

@1 : ZIntSET.main # 24

this

--

ZIntSET

Node	key = 41
------	----------

Node	key = 61
------	----------

Node	key = 21
------	----------

Node	key = 11
------	----------

Node	key = 31
------	----------

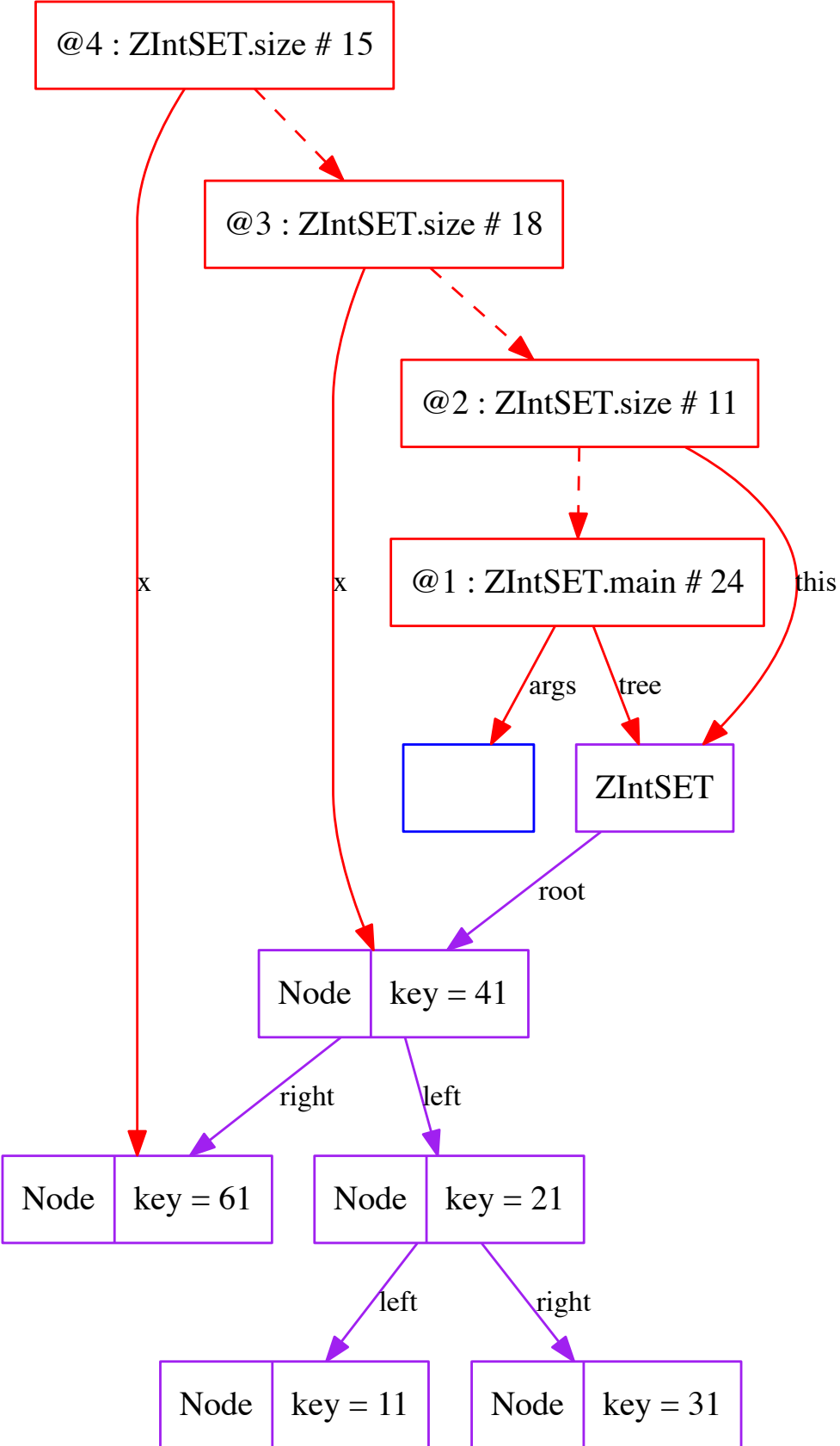

ZIntSET	sz = 4
---------	--------

@4 : ZIntSET.size # 16

@3 : ZIntSET.size # 18

@2 : ZIntSET.size # 11

@1 : ZIntSET.main # 24

this

--

ZIntSET

Node	key = 41
------	----------

Node	key = 61
------	----------

Node	key = 21
------	----------

Node	key = 11
------	----------

Node	key = 31
------	----------

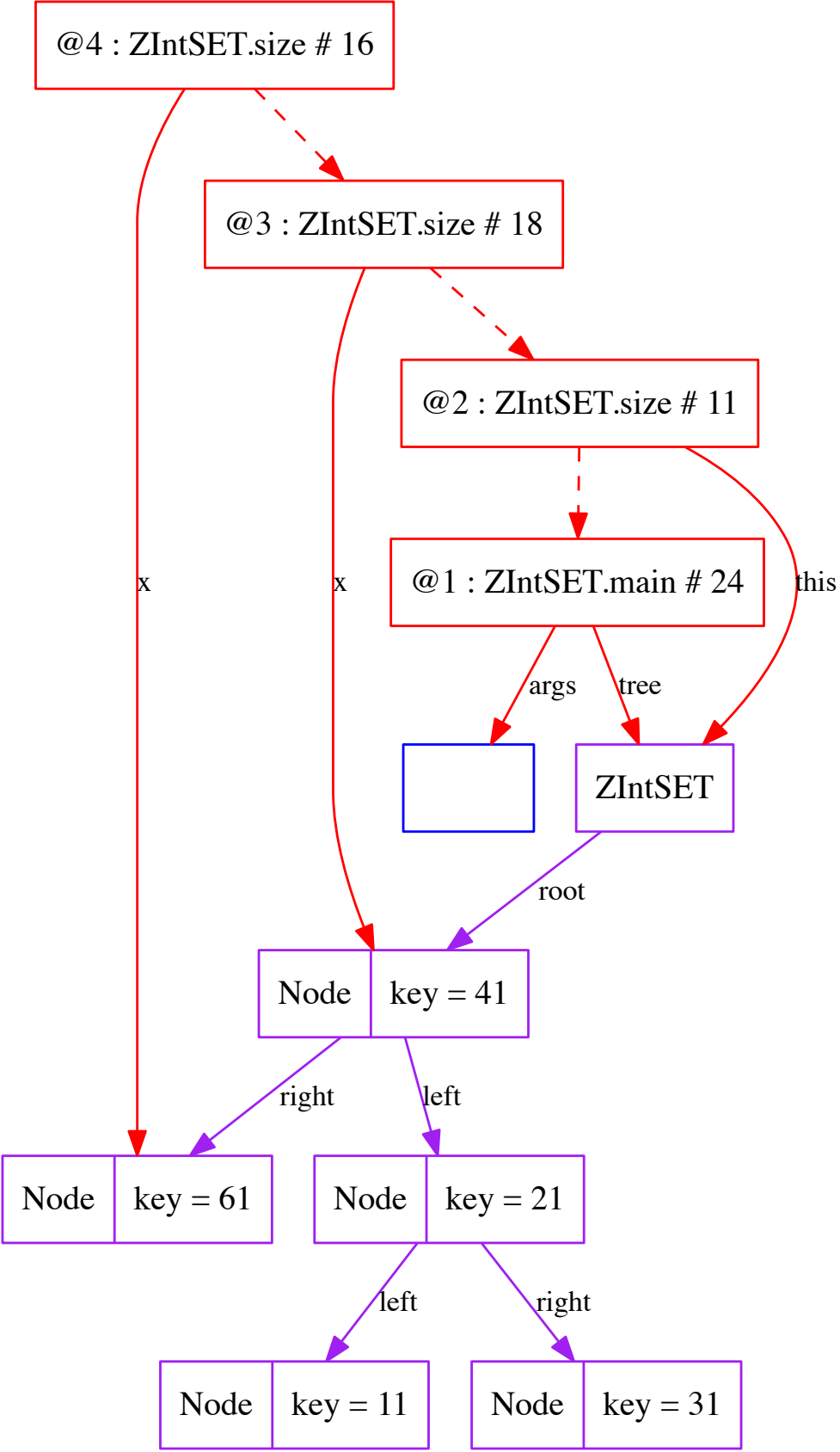

ZIntSET	sz = 5
---------	--------

@4 : ZIntSET.size # 17

@3 : ZIntSET.size # 18

@2 : ZIntSET.size # 11

@1 : ZIntSET.main # 24

ZIntSET

Node	key = 41
------	----------

Node	key = 61
------	----------

Node	key = 21
------	----------

Node	key = 11
------	----------

Node	key = 31
------	----------

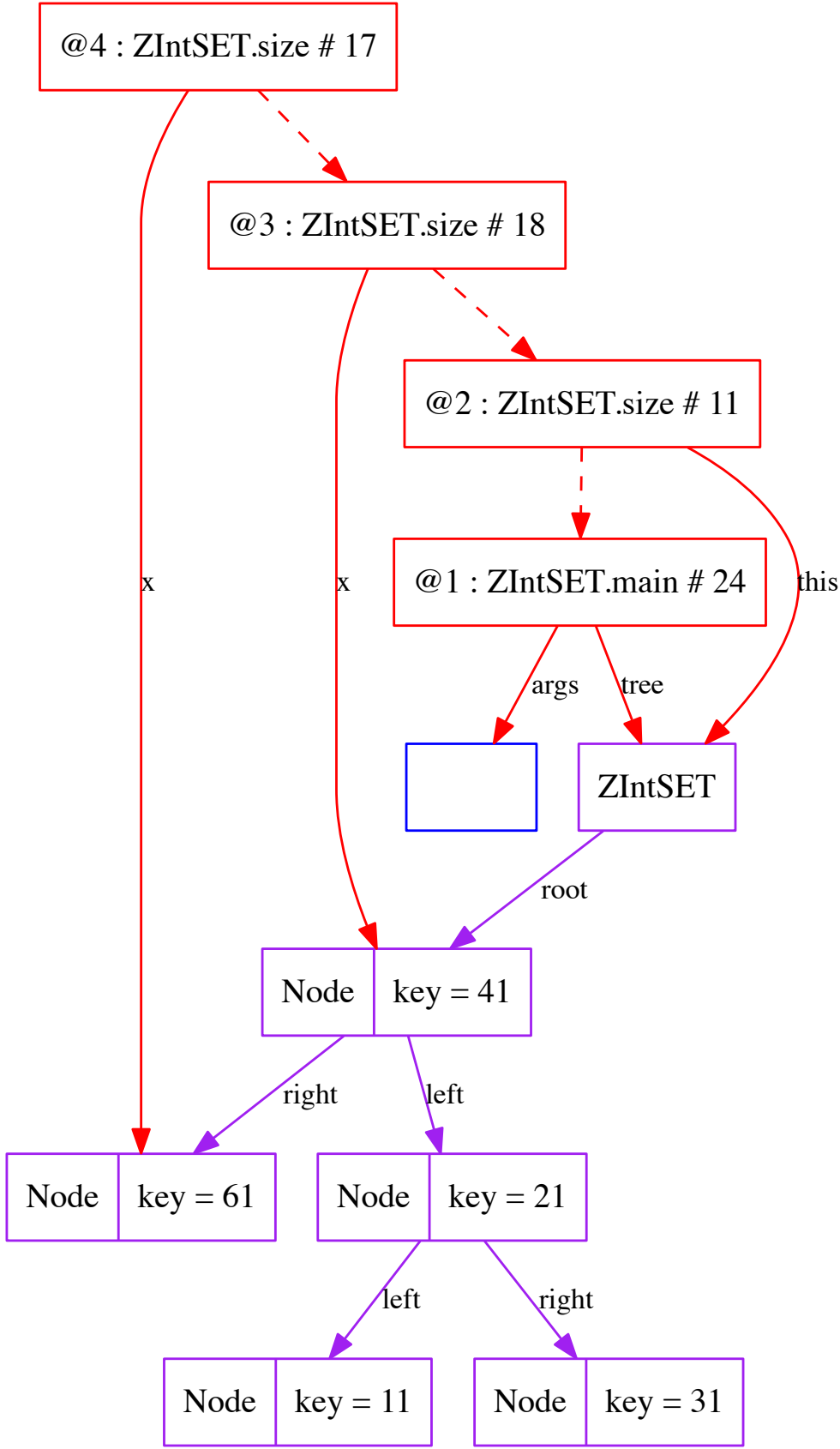

ZIntSET	sz = 5
---------	--------

@5 : ZIntSET.size # 15	x = null
------------------------	----------

@4 : ZIntSET.size # 17

@3 : ZIntSET.size # 18

@2 : ZIntSET.size # 11

@1 : ZIntSET.main # 24

--

ZIntSET

Node	key = 41
------	----------

Node	key = 61
------	----------

Node	key = 21
------	----------

Node	key = 11
------	----------

Node	key = 31
------	----------

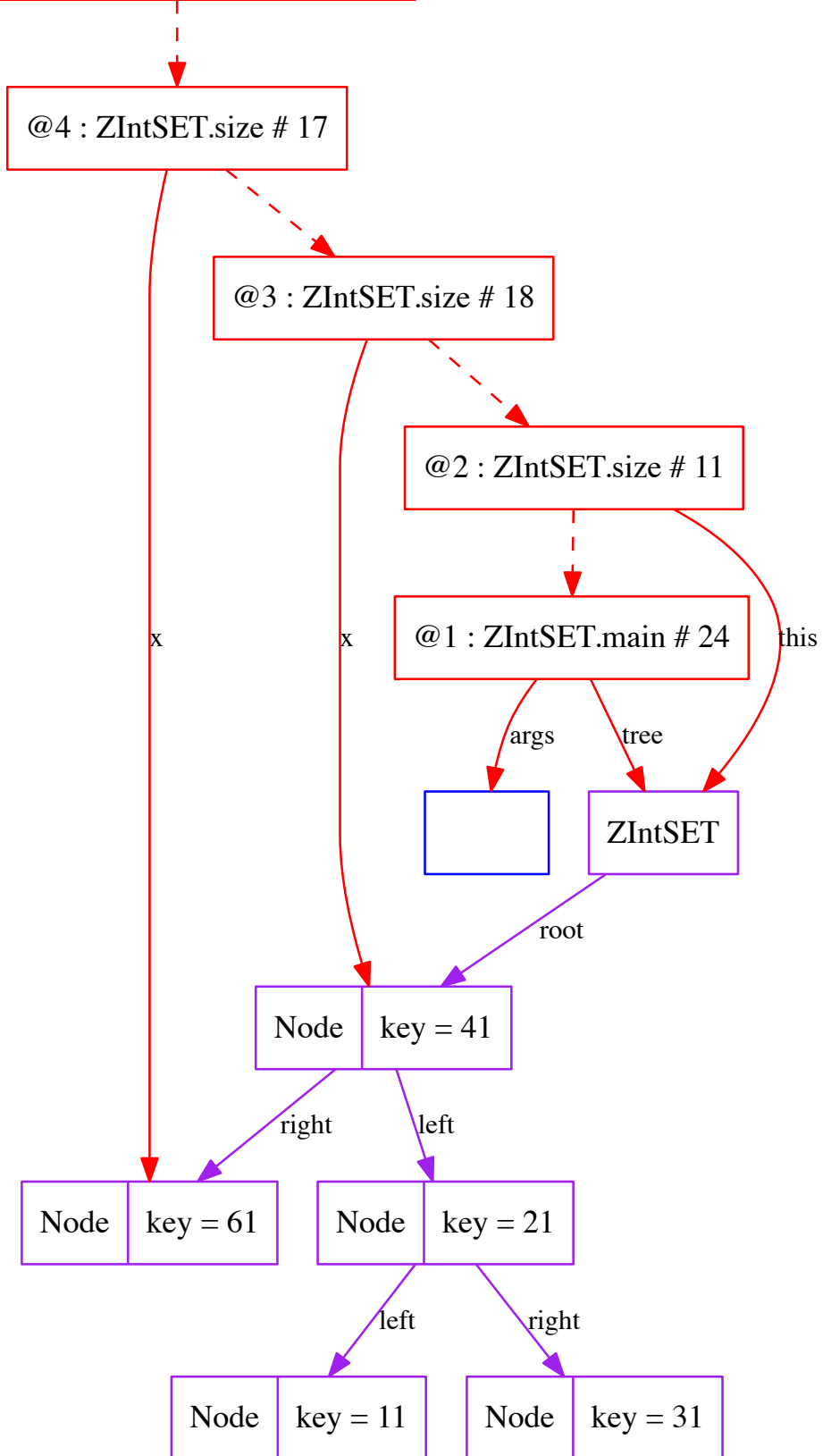

ZIntSET	sz = 5
---------	--------

@5 : returnValue = 5

@4 : ZIntSET.size # 17

@3 : ZIntSET.size # 18

@2 : ZIntSET.size # 11

@1 : ZIntSET.main # 24

ZIntSET

Node key = 41

Node key = 61

Node key = 21

Node key = 11

Node key = 31

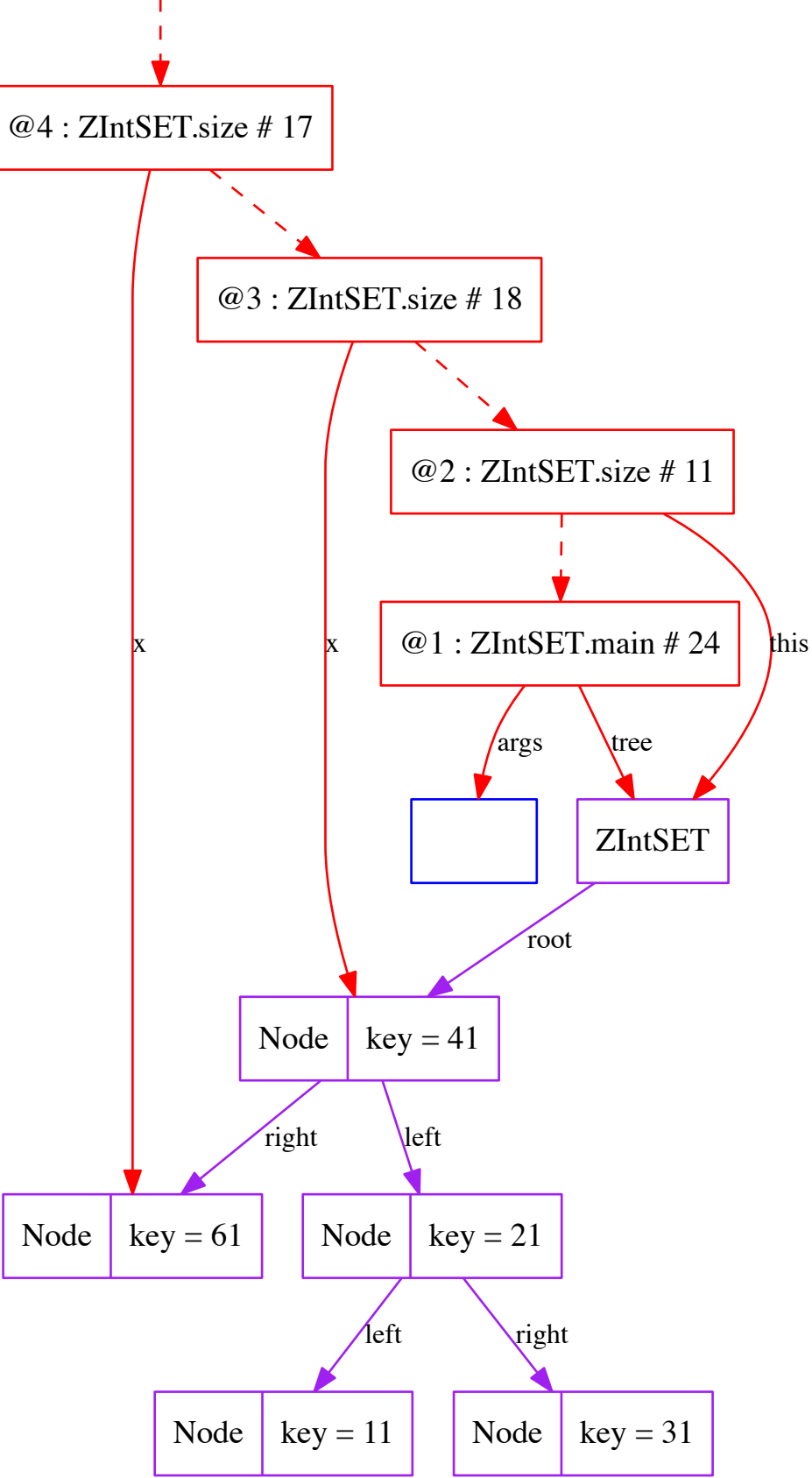

ZIntSET	sz = 5
---------	--------

@4 : ZIntSET.size # 18

@3 : ZIntSET.size # 18

@2 : ZIntSET.size # 11

@1 : ZIntSET.main # 24

--

ZIntSET

Node	key = 41
------	----------

Node	key = 61
------	----------

Node	key = 21
------	----------

Node	key = 11
------	----------

Node	key = 31
------	----------

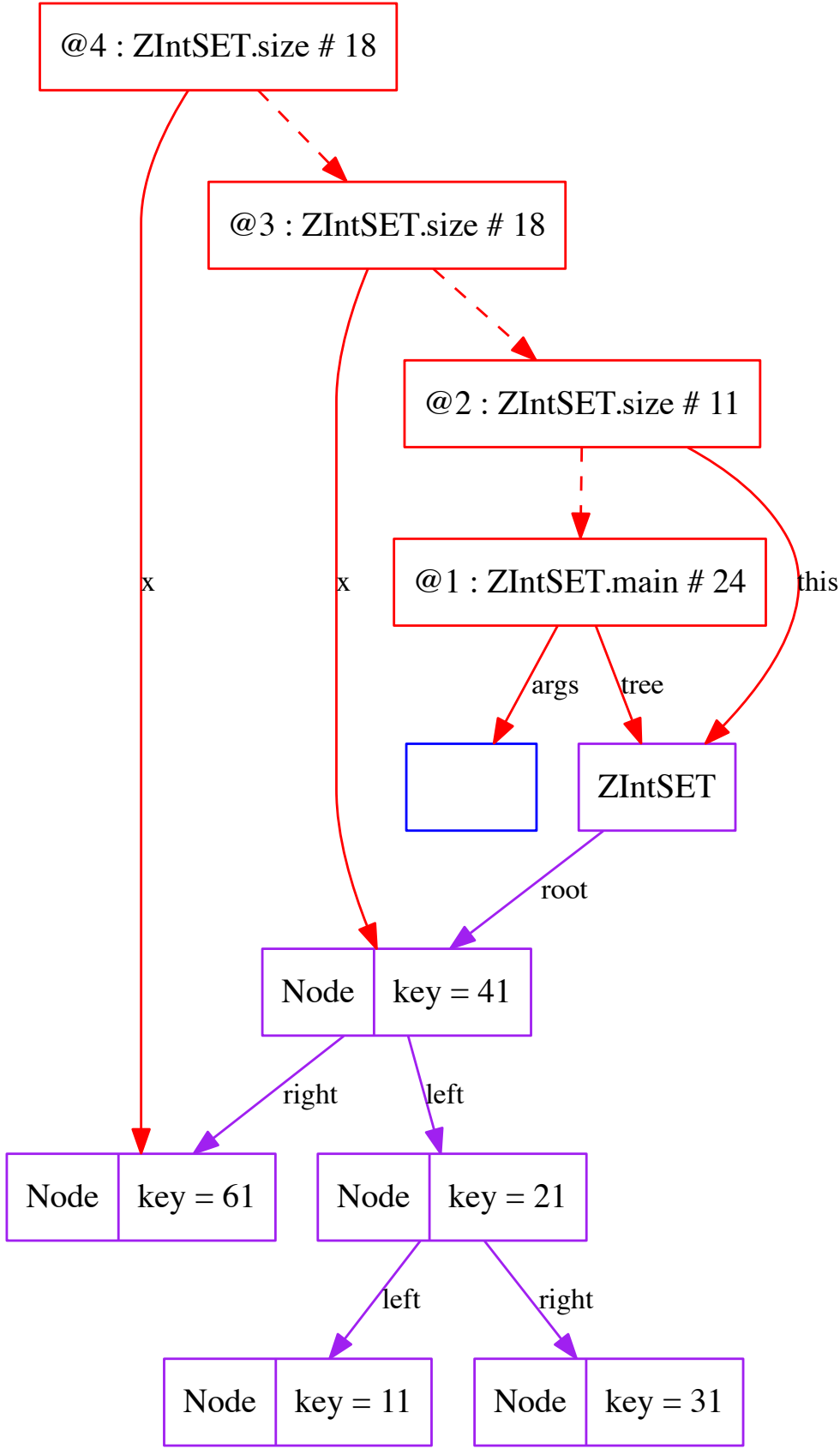

ZIntSET	sz = 5
---------	--------

@5 : ZIntSET.size # 15	x = null
------------------------	----------

@4 : ZIntSET.size # 18

@3 : ZIntSET.size # 18

@2 : ZIntSET.size # 11

@1 : ZIntSET.main # 24

--

ZIntSET

Node	key = 41
------	----------

Node	key = 61
------	----------

Node	key = 21
------	----------

Node	key = 11
------	----------

Node	key = 31
------	----------

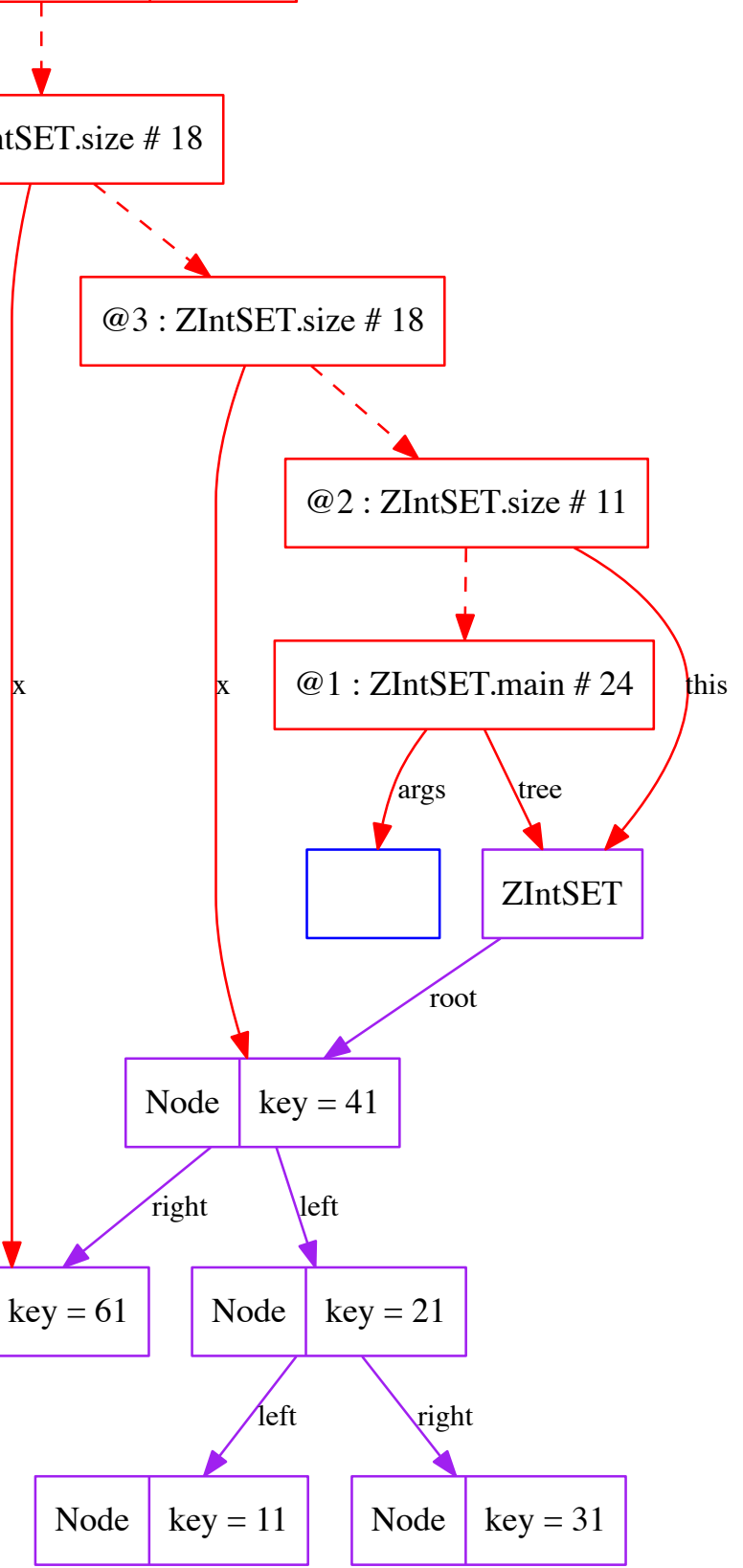

ZIntSET	sz = 5
---------	--------

@5 : returnValue = 5

@4 : ZIntSET.size # 18

@3 : ZIntSET.size # 18

@2 : ZIntSET.size # 11

@1 : ZIntSET.main # 24

ZIntSET

Node key = 41

Node key = 61

Node key = 21

Node key = 11

Node key = 31

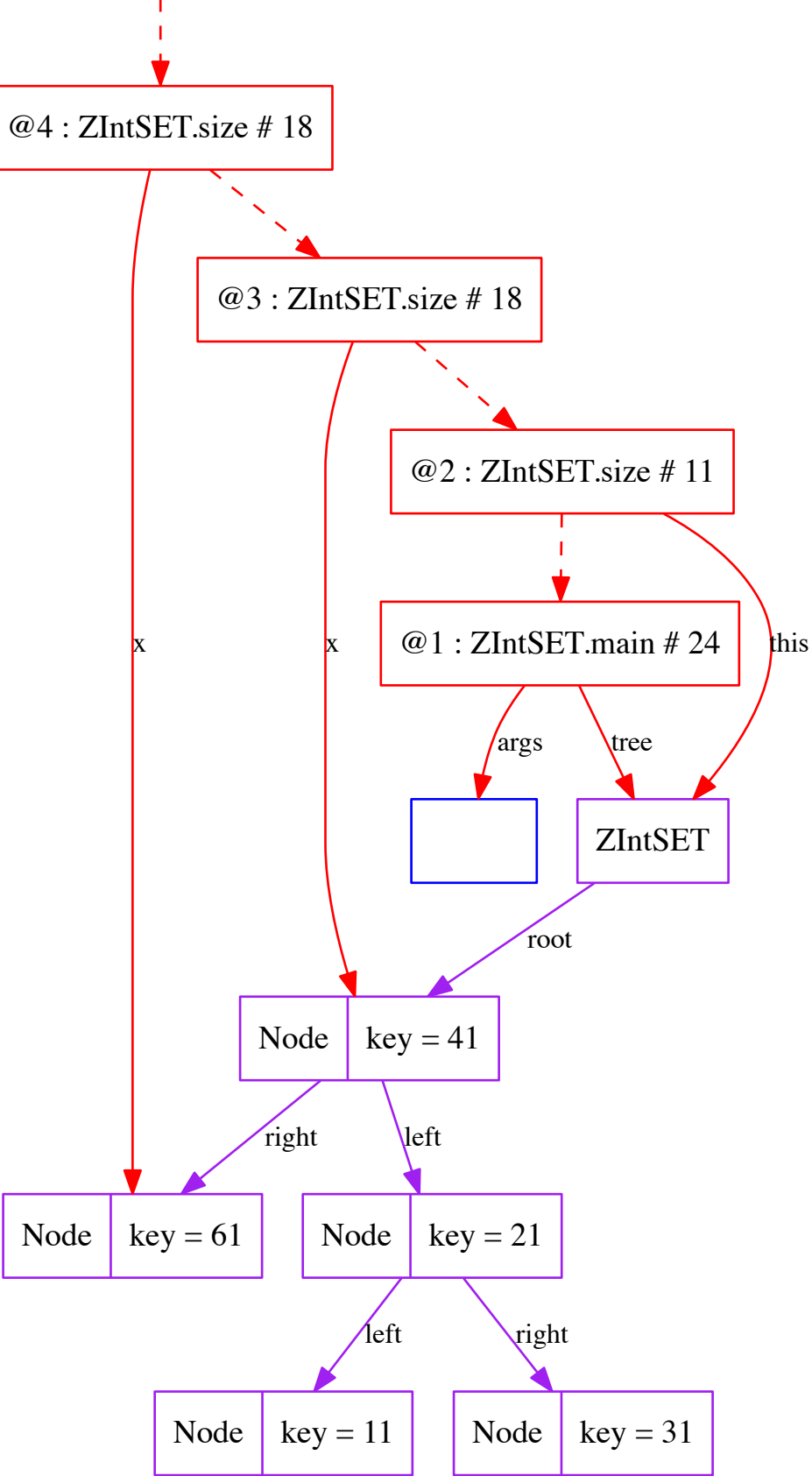

ZIntSET	sz = 5
---------	--------

@4 : ZIntSET.size # 19

@3 : ZIntSET.size # 18

@2 : ZIntSET.size # 11

@1 : ZIntSET.main # 24

ZIntSET

Node	key = 41
------	----------

Node	key = 61
------	----------

Node	key = 21
------	----------

Node	key = 11
------	----------

Node	key = 31
------	----------

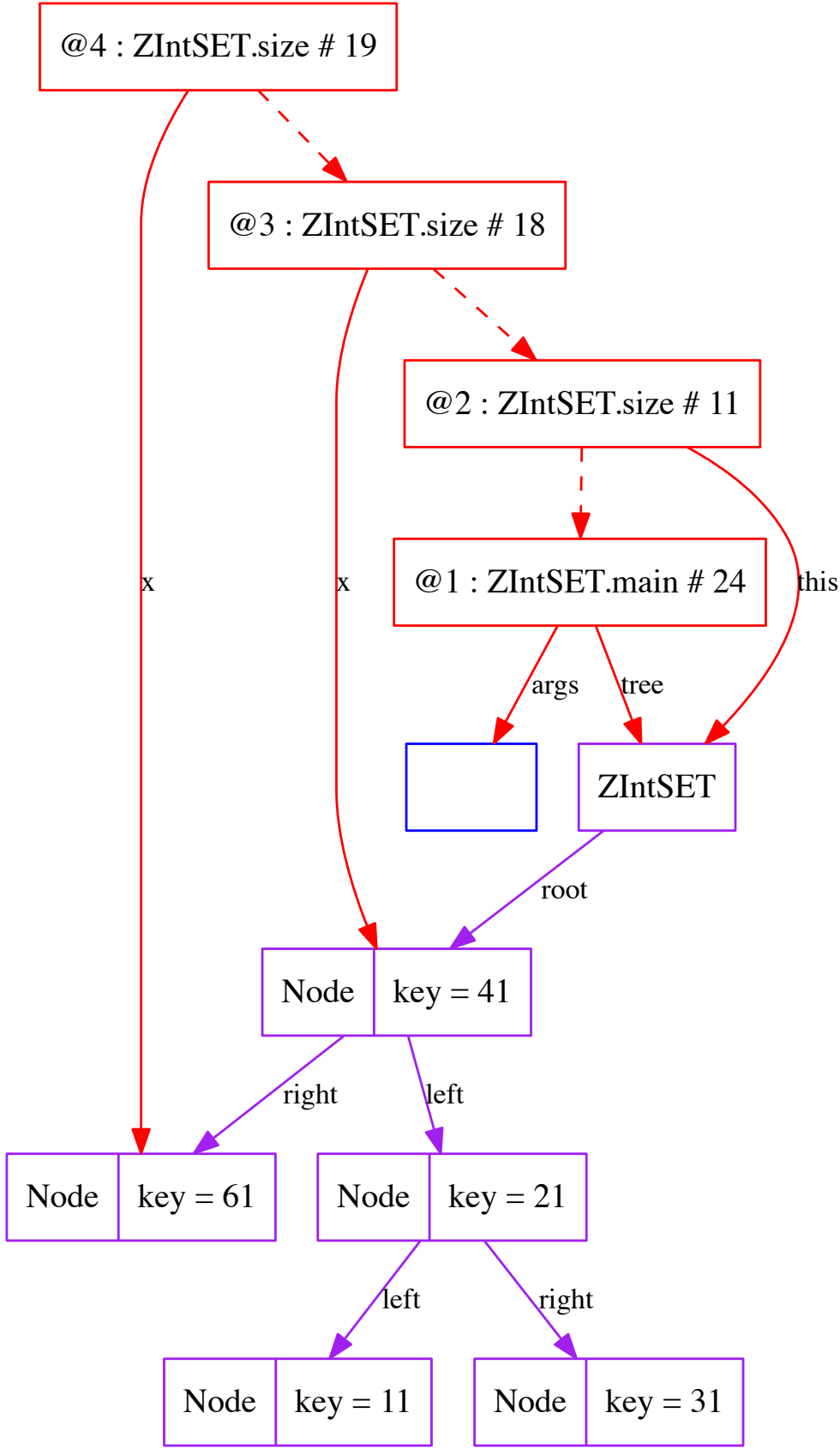

ZIntSET	sz = 5
---------	--------

@4 : returnValue = 5

@3 : ZIntSET.size # 18

@2 : ZIntSET.size # 11

@1 : ZIntSET.main # 24

ZIntSET

Node key = 41

Node key = 21

Node key = 61

Node key = 11

Node key = 31

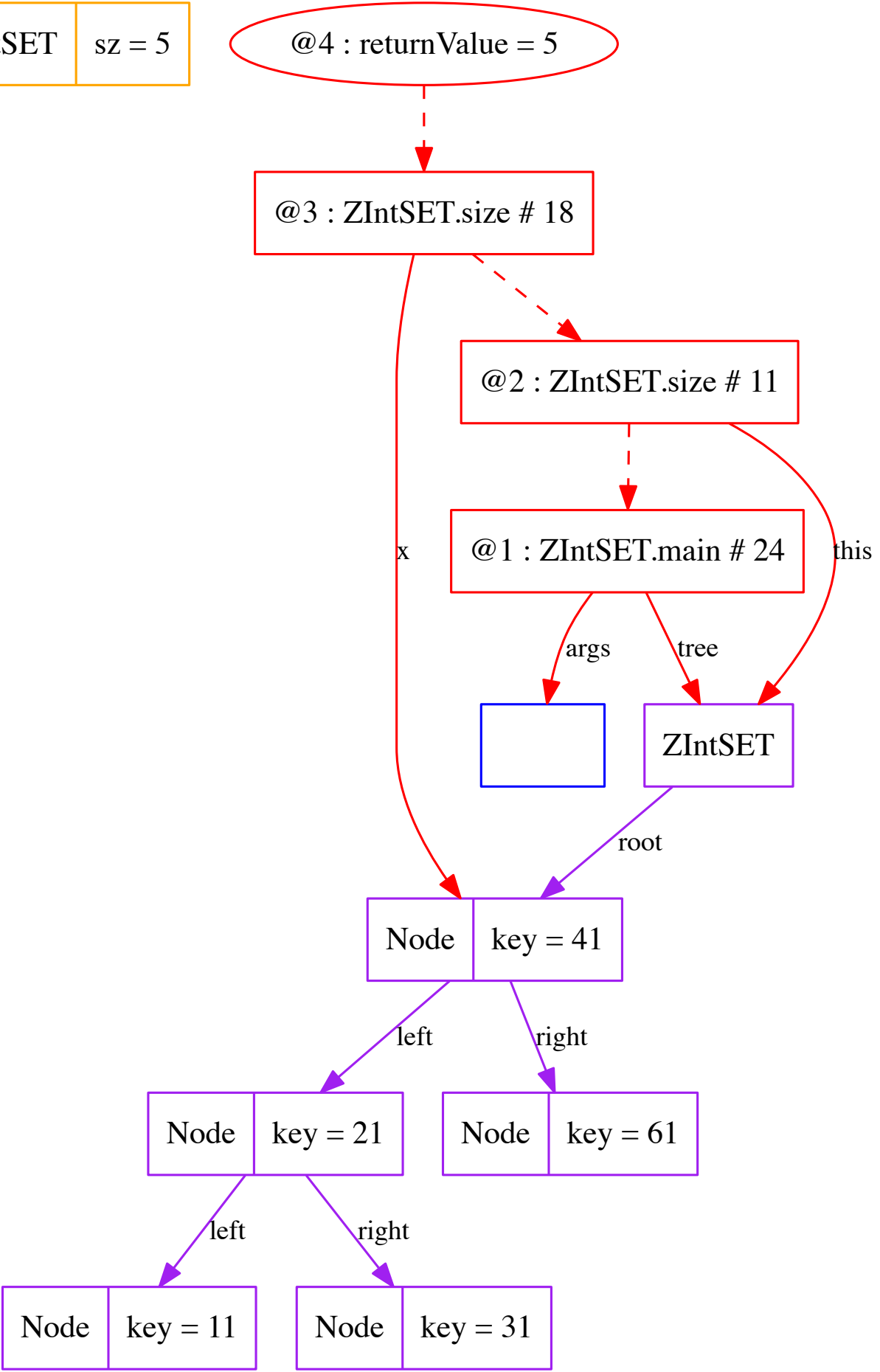

ZIntSET	sz = 5
---------	--------

@3 : ZIntSET.size # 19

@2 : ZIntSET.size # 11

@1 : ZIntSET.main # 24

--

ZIntSET

Node	key = 41
------	----------

Node	key = 21
------	----------

Node	key = 61
------	----------

Node	key = 11
------	----------

Node	key = 31
------	----------

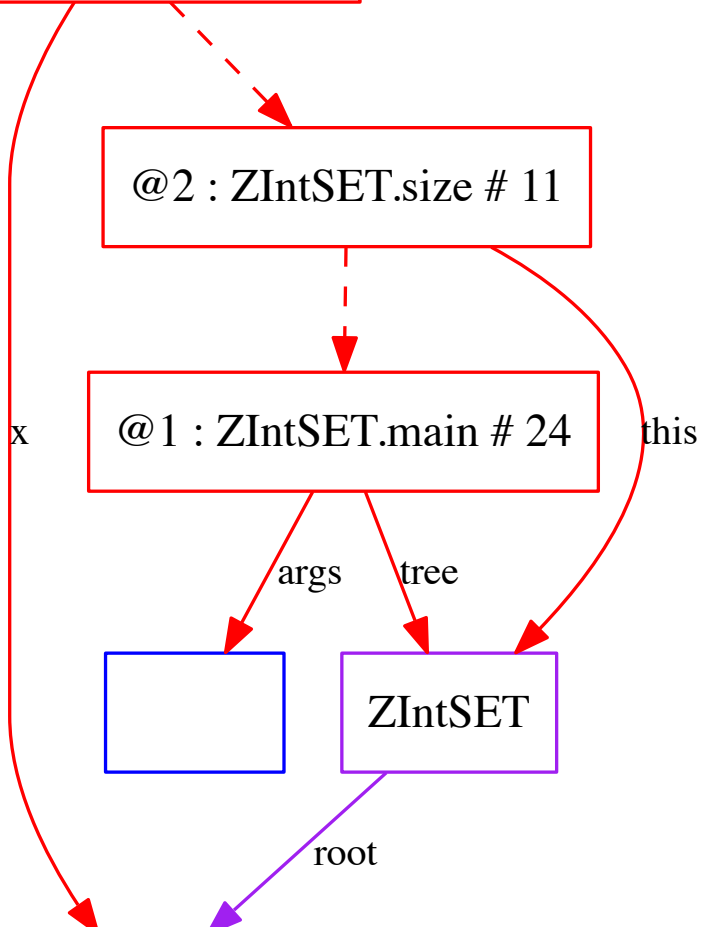

ZIntSET	sz = 5
---------	--------

@3 : returnValue = 5

@2 : ZIntSET.size # 11

@1 : ZIntSET.main # 24

this

args

tree

ZIntSET

root

Node	key = 41
------	----------

left

right

Node	key = 21
------	----------

Node	key = 61
------	----------

left

right

Node	key = 11
------	----------

Node	key = 31
------	----------

ZIntSET	sz = 5
---------	--------

@3 : returnValue = 5

@2 : ZIntSET.size # 12

@1 : ZIntSET.main # 24

ZIntSET

Node key = 41

Node key = 21

Node key = 61

Node key = 11

Node key = 31

ZIntSET	sz = 5
---------	--------

@2 : ZIntSET.size # 11

@1 : ZIntSET.main # 25

--

ZIntSET

Node	key = 41
------	----------

Node	key = 21
------	----------

Node	key = 61
------	----------

Node	key = 11
------	----------

Node	key = 31
------	----------

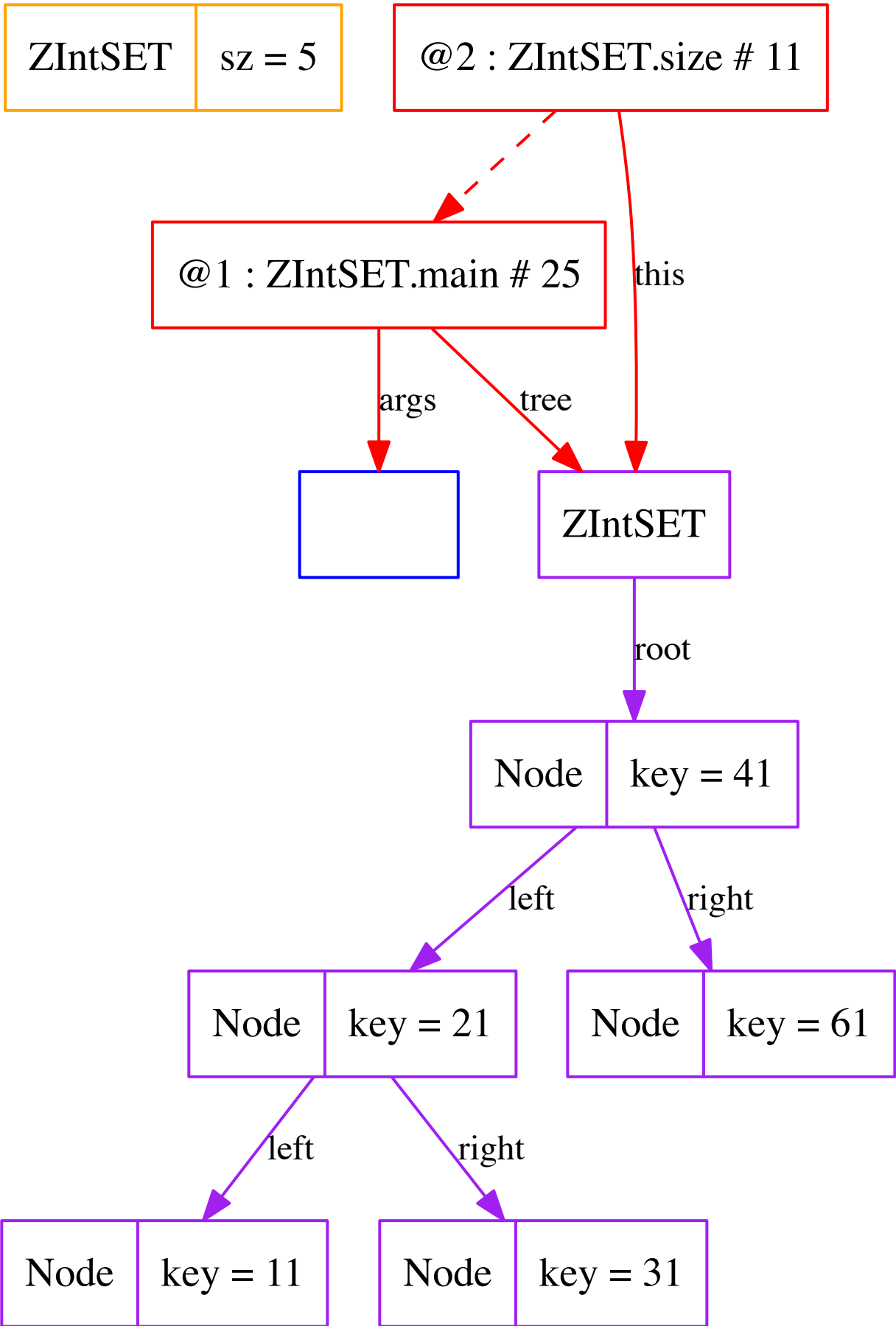

ZIntSET	sz = 5
---------	--------

@2 : ZIntSET.size # 12

@1 : ZIntSET.main # 25

--

ZIntSET

Node	key = 41
------	----------

Node	key = 21
------	----------

Node	key = 61
------	----------

Node	key = 11
------	----------

Node	key = 31
------	----------

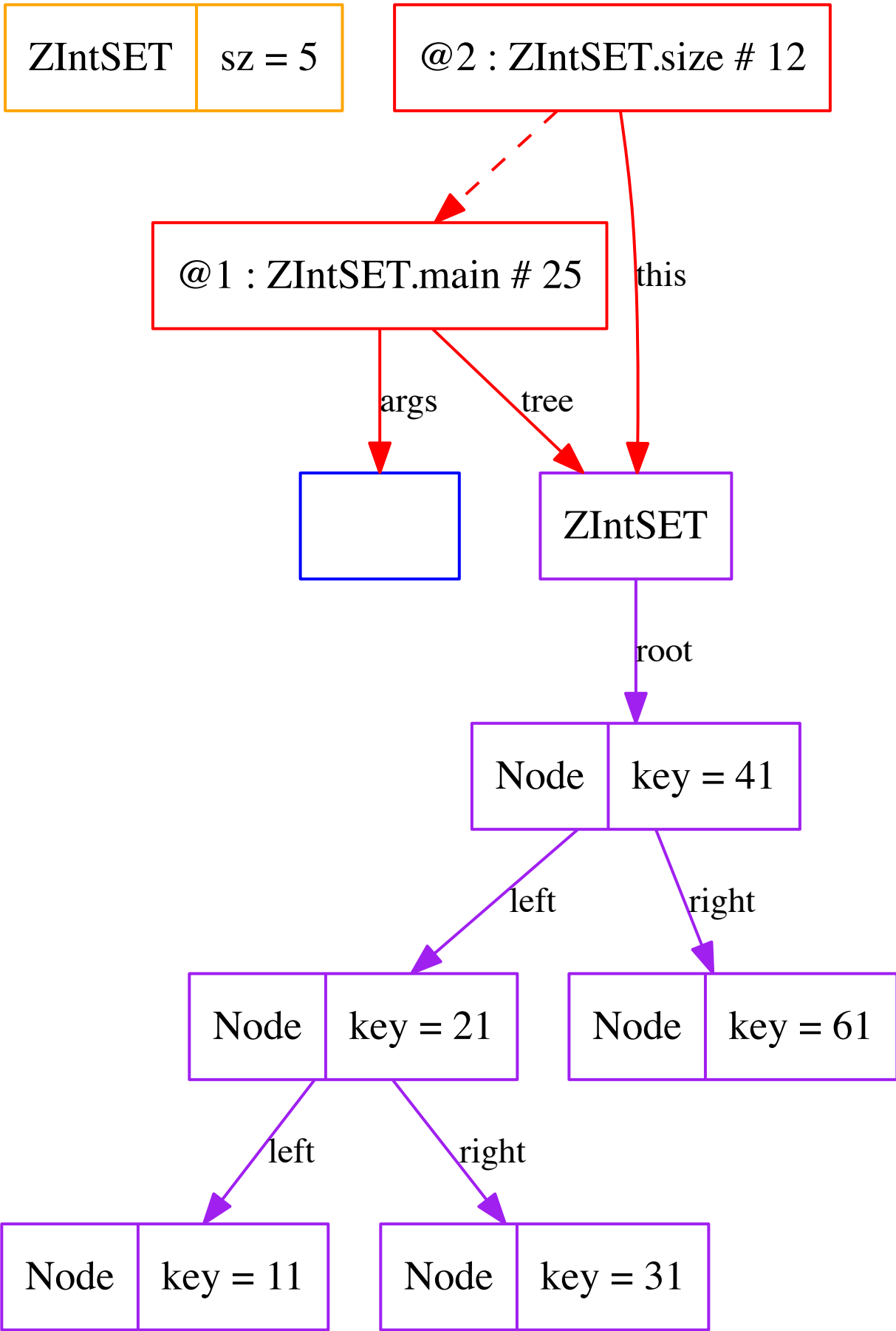

ZIntSET	sz = 5
---------	--------

@3 : ZIntSET.size # 15

@2 : ZIntSET.size # 11

@1 : ZIntSET.main # 25

--

ZIntSET

Node	key = 41
------	----------

Node	key = 21
------	----------

Node	key = 61
------	----------

Node	key = 11
------	----------

Node	key = 31
------	----------

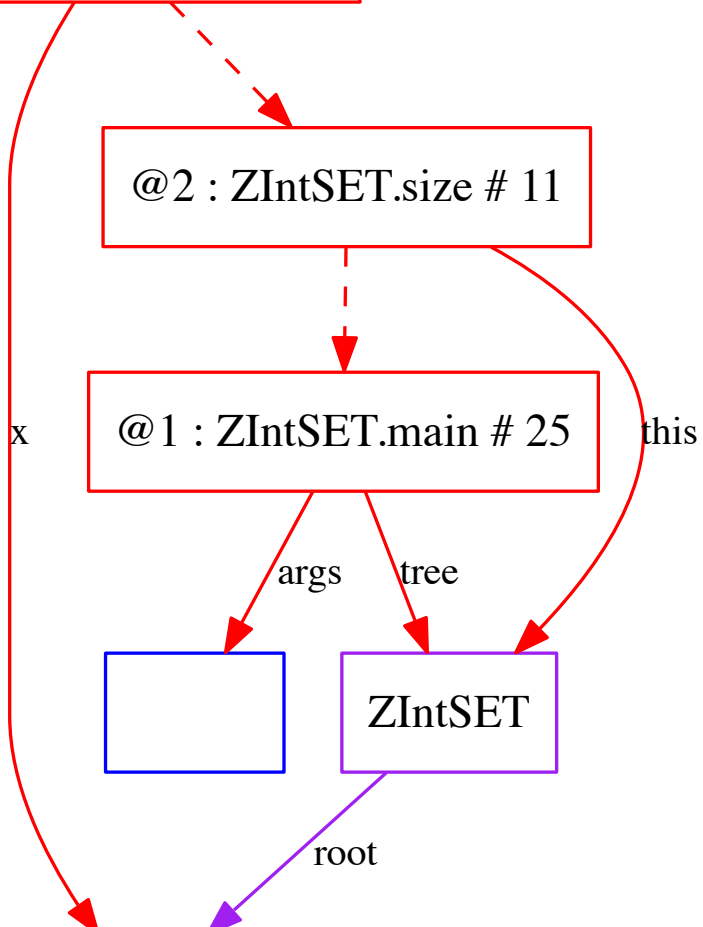

ZIntSET	sz = 5
---------	--------

@3 : ZIntSET.size # 16

@2 : ZIntSET.size # 11

@1 : ZIntSET.main # 25

--

ZIntSET

Node	key = 41
------	----------

Node	key = 21
------	----------

Node	key = 61
------	----------

Node	key = 11
------	----------

Node	key = 31
------	----------

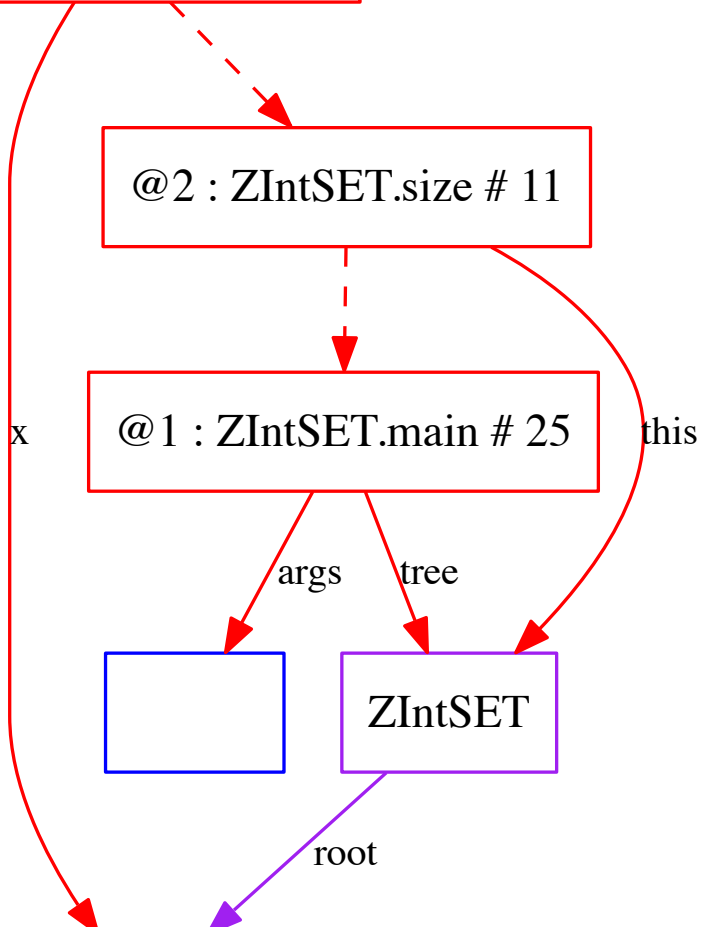

ZIntSET	sz = 6
---------	--------

@3 : ZIntSET.size # 17

@2 : ZIntSET.size # 11

@1 : ZIntSET.main # 25

--

ZIntSET

Node	key = 41
------	----------

Node	key = 21
------	----------

Node	key = 61
------	----------

Node	key = 11
------	----------

Node	key = 31
------	----------

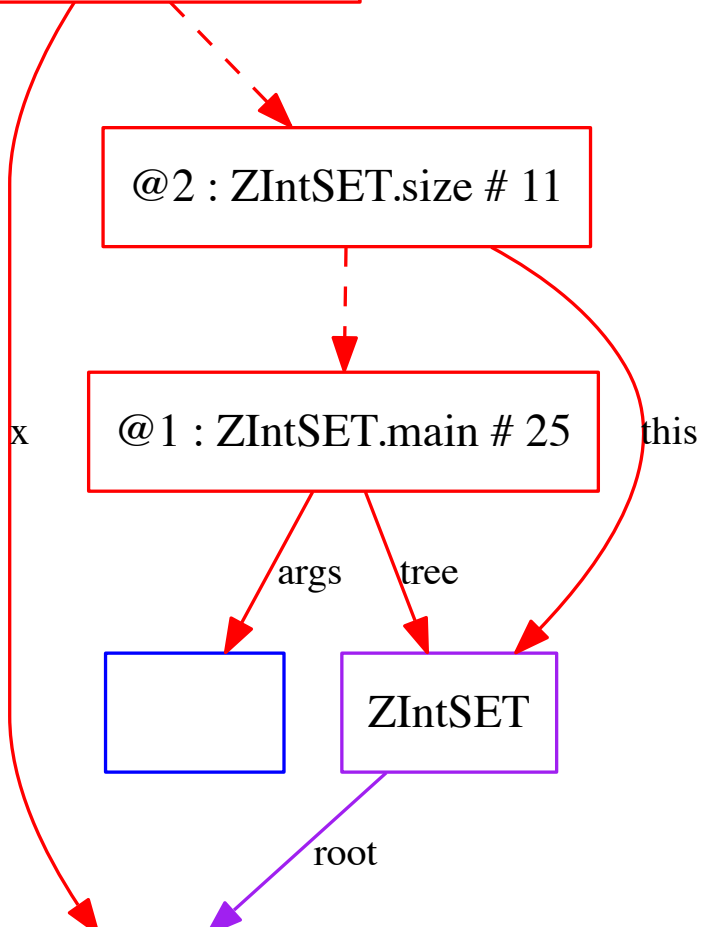

ZIntSET	sz = 6
---------	--------

@4 : ZIntSET.size # 15

@3 : ZIntSET.size # 17

@2 : ZIntSET.size # 11

@1 : ZIntSET.main # 25

--

ZIntSET

Node	key = 41
------	----------

Node	key = 21
------	----------

Node	key = 61
------	----------

Node	key = 11
------	----------

Node	key = 31
------	----------

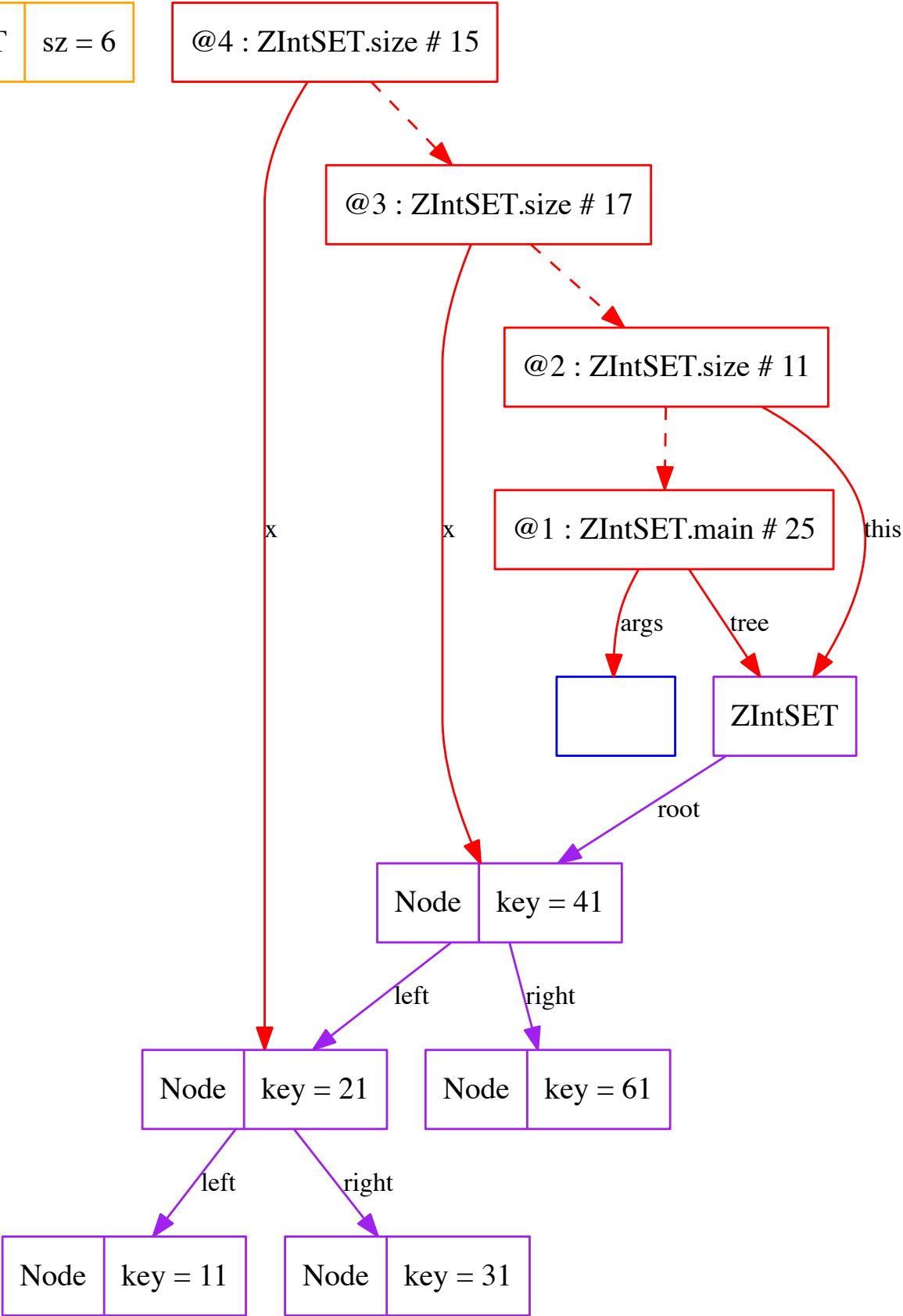

ZIntSET	sz = 6
---------	--------

@4 : ZIntSET.size # 16

@3 : ZIntSET.size # 17

@2 : ZIntSET.size # 11

@1 : ZIntSET.main # 25

--

ZIntSET

Node	key = 41
------	----------

Node	key = 21
------	----------

Node	key = 61
------	----------

Node	key = 11
------	----------

Node	key = 31
------	----------

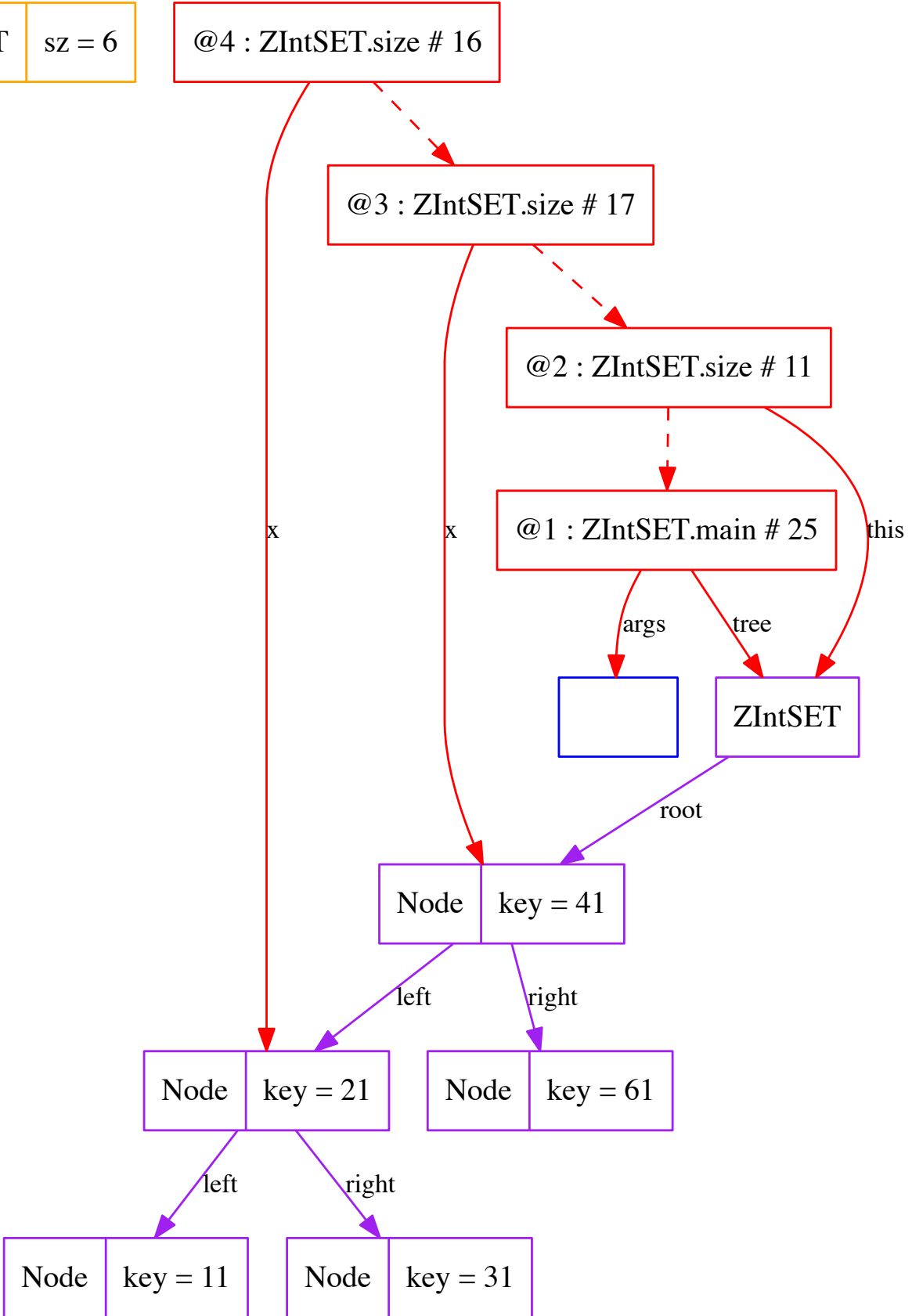

ZIntSET	sz = 7
---------	--------

@4 : ZIntSET.size # 17

@3 : ZIntSET.size # 17

@2 : ZIntSET.size # 11

@1 : ZIntSET.main # 25

--

ZIntSET

Node	key = 41
------	----------

Node	key = 21
------	----------

Node	key = 61
------	----------

Node	key = 11
------	----------

Node	key = 31
------	----------

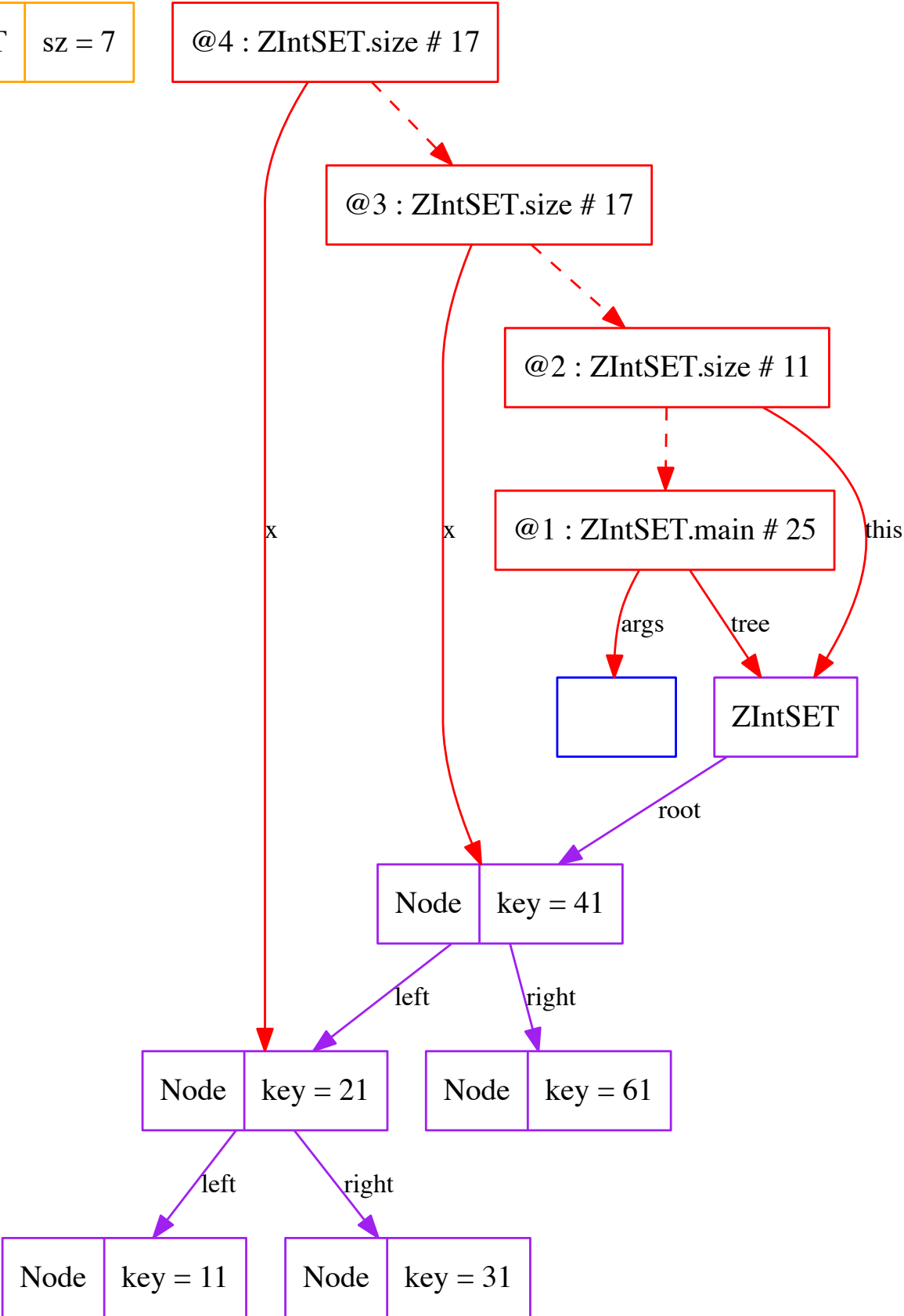

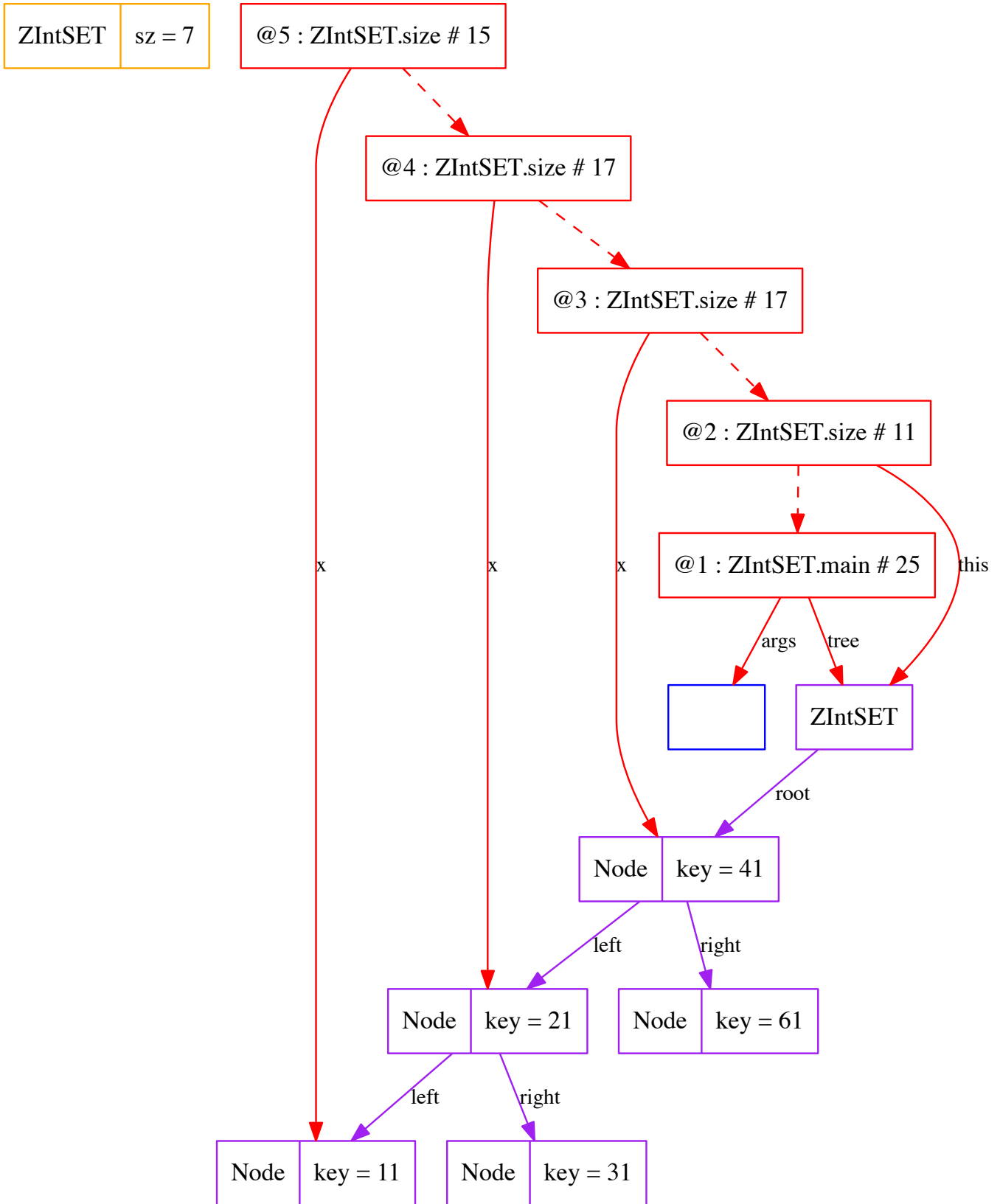

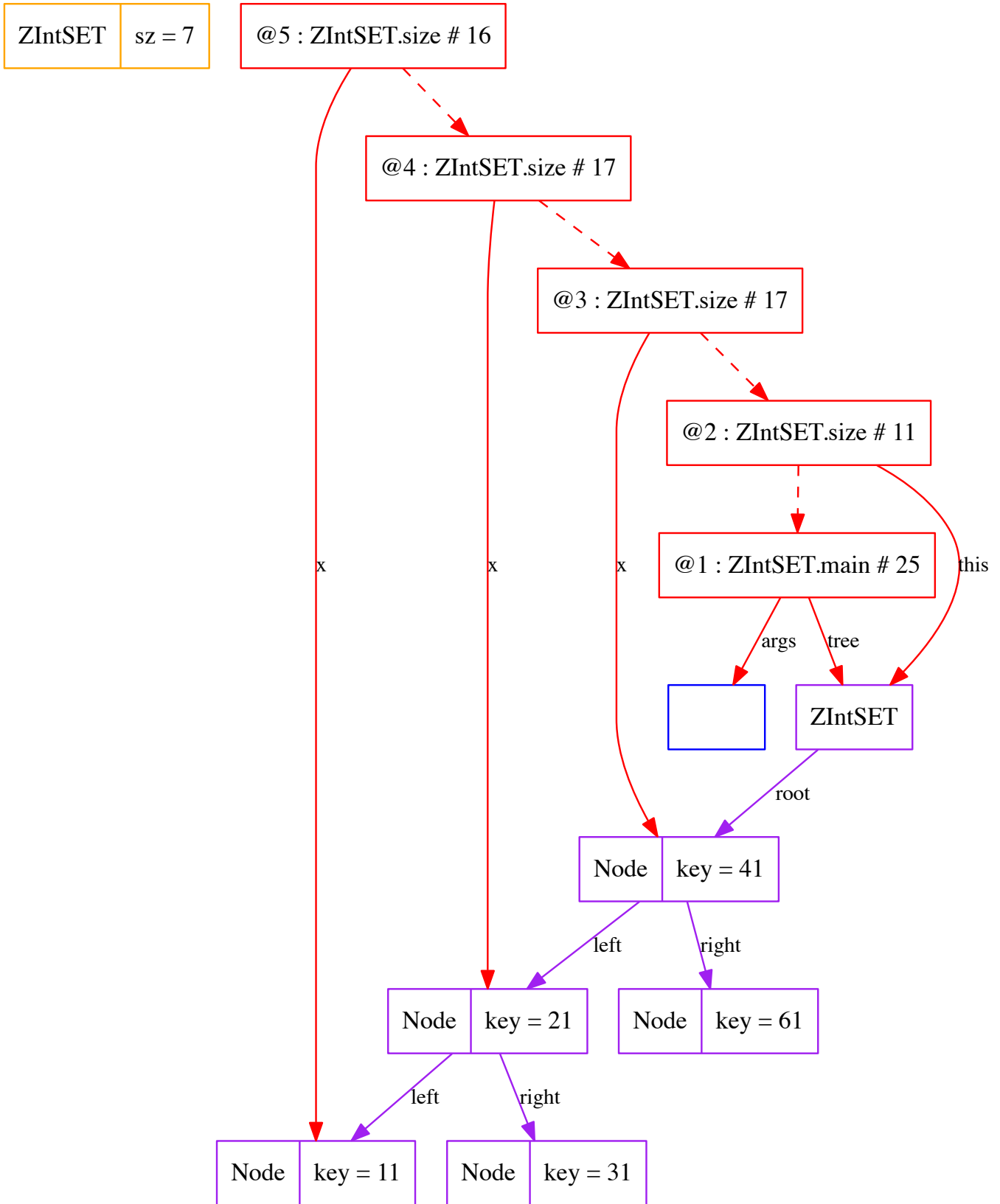

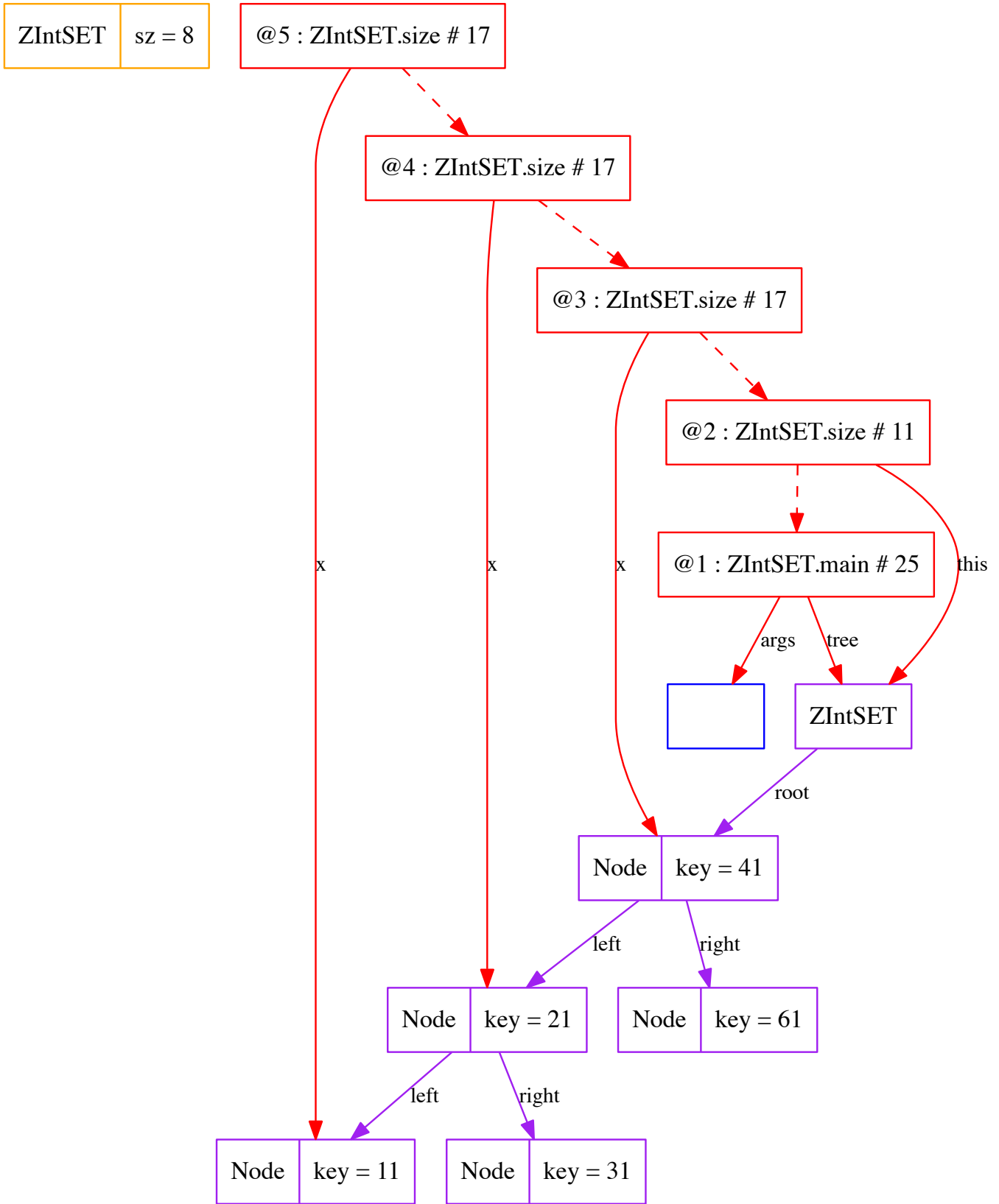

ZIntSET	sz = 8
---------	--------

@6 : ZIntSET.size # 15	x = null
------------------------	----------

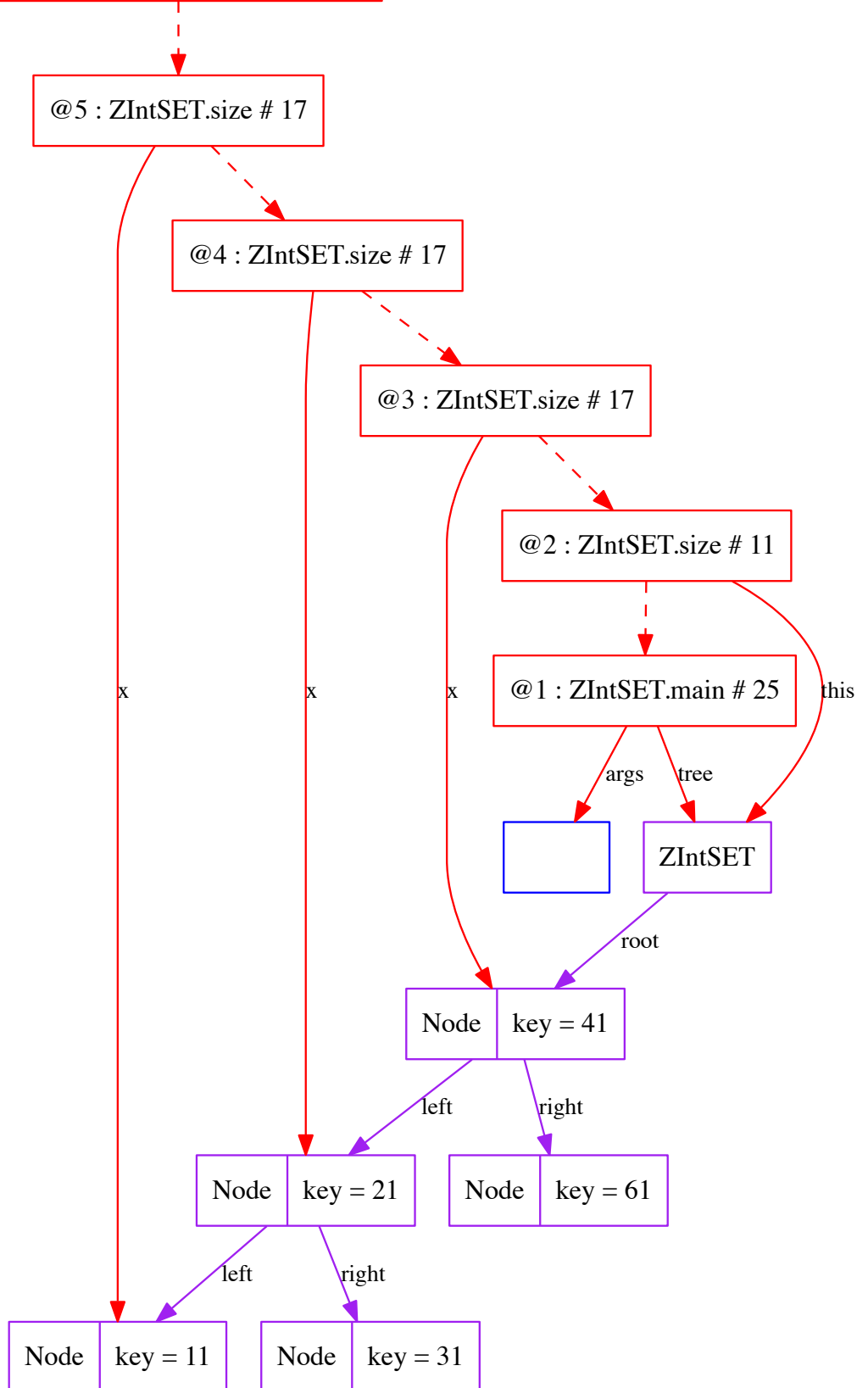

ZIntSET	sz = 8
---------	--------

@6 : returnValue = 8

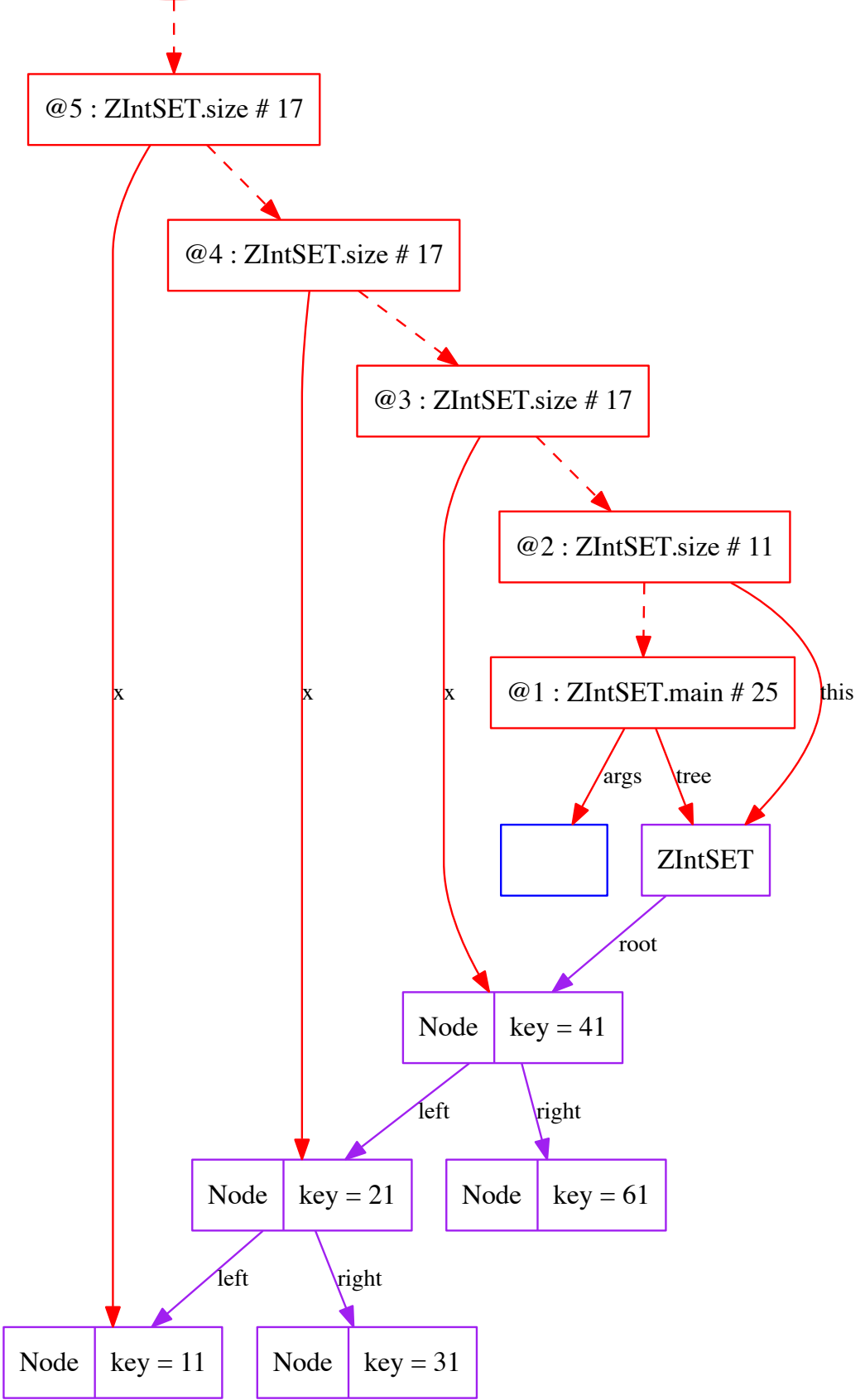

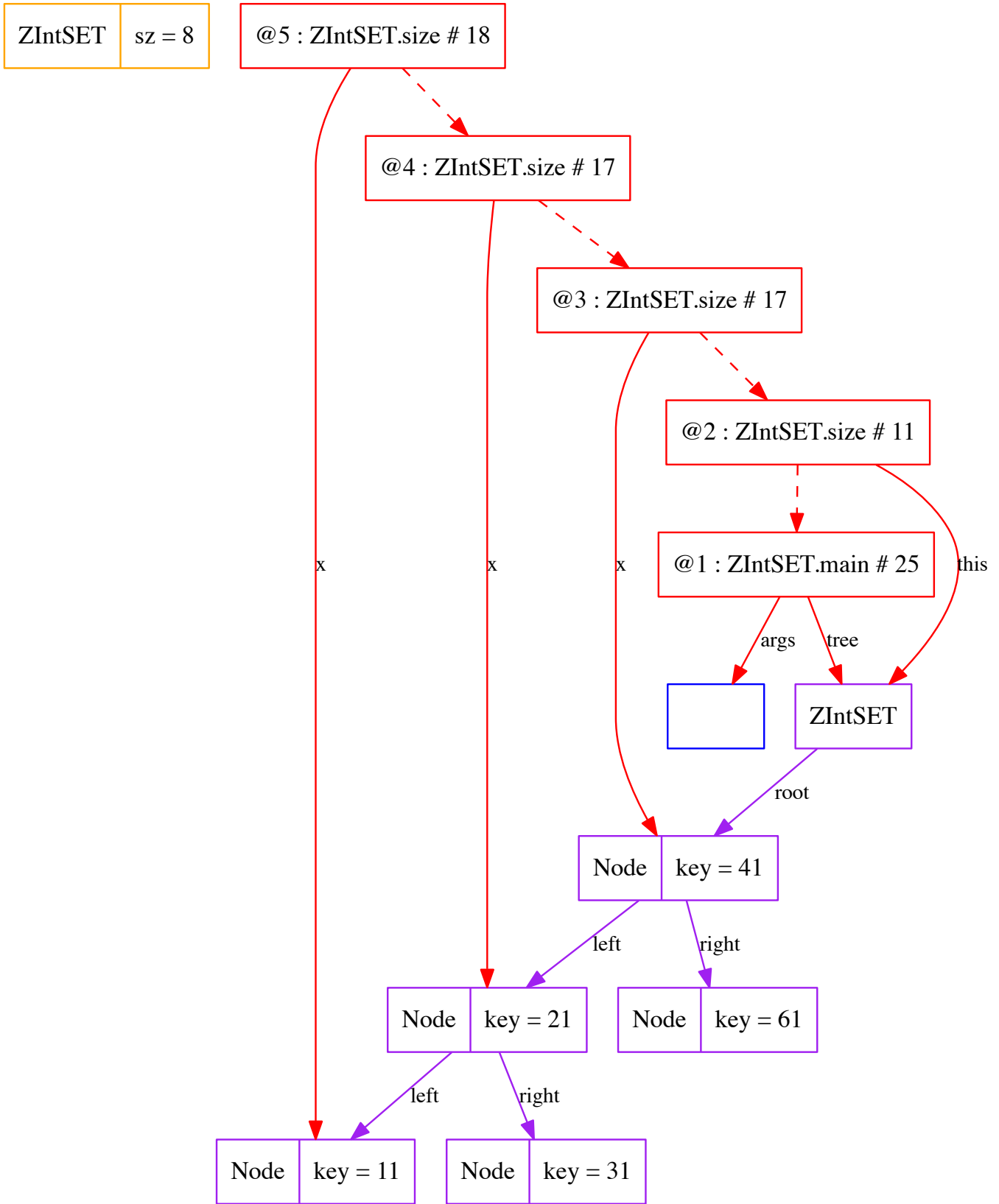

ZIntSET	sz = 8
---------	--------

@6 : ZIntSET.size # 15	x = null
------------------------	----------

@5 : ZIntSET.size # 18

@4 : ZIntSET.size # 17

@3 : ZIntSET.size # 17

@2 : ZIntSET.size # 11

@1 : ZIntSET.main # 25

--

ZIntSET

Node	key = 41
------	----------

Node	key = 21
------	----------

Node	key = 61
------	----------

Node	key = 11
------	----------

Node	key = 31
------	----------

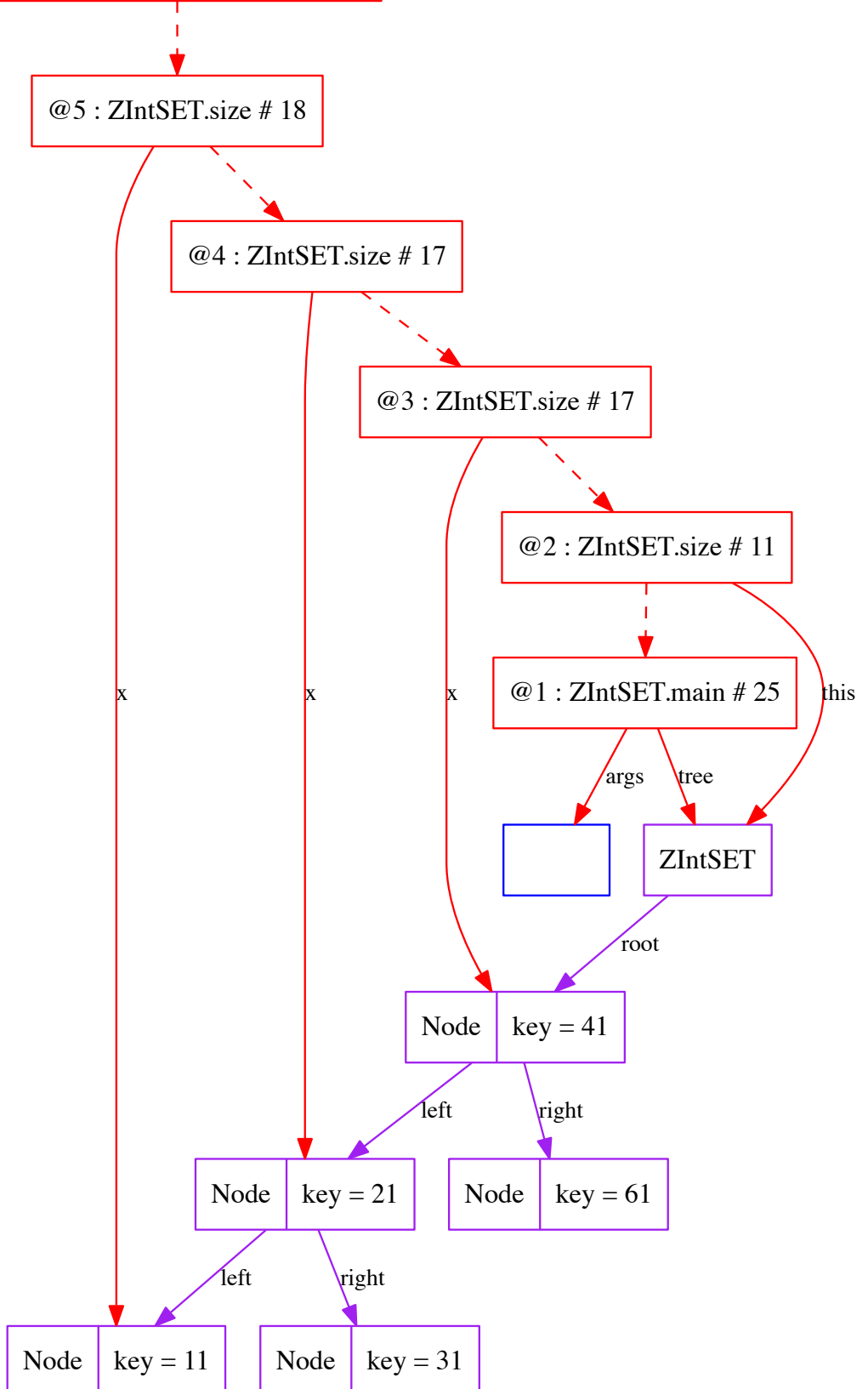

ZIntSET	sz = 8
---------	--------

@6 : returnValue = 8

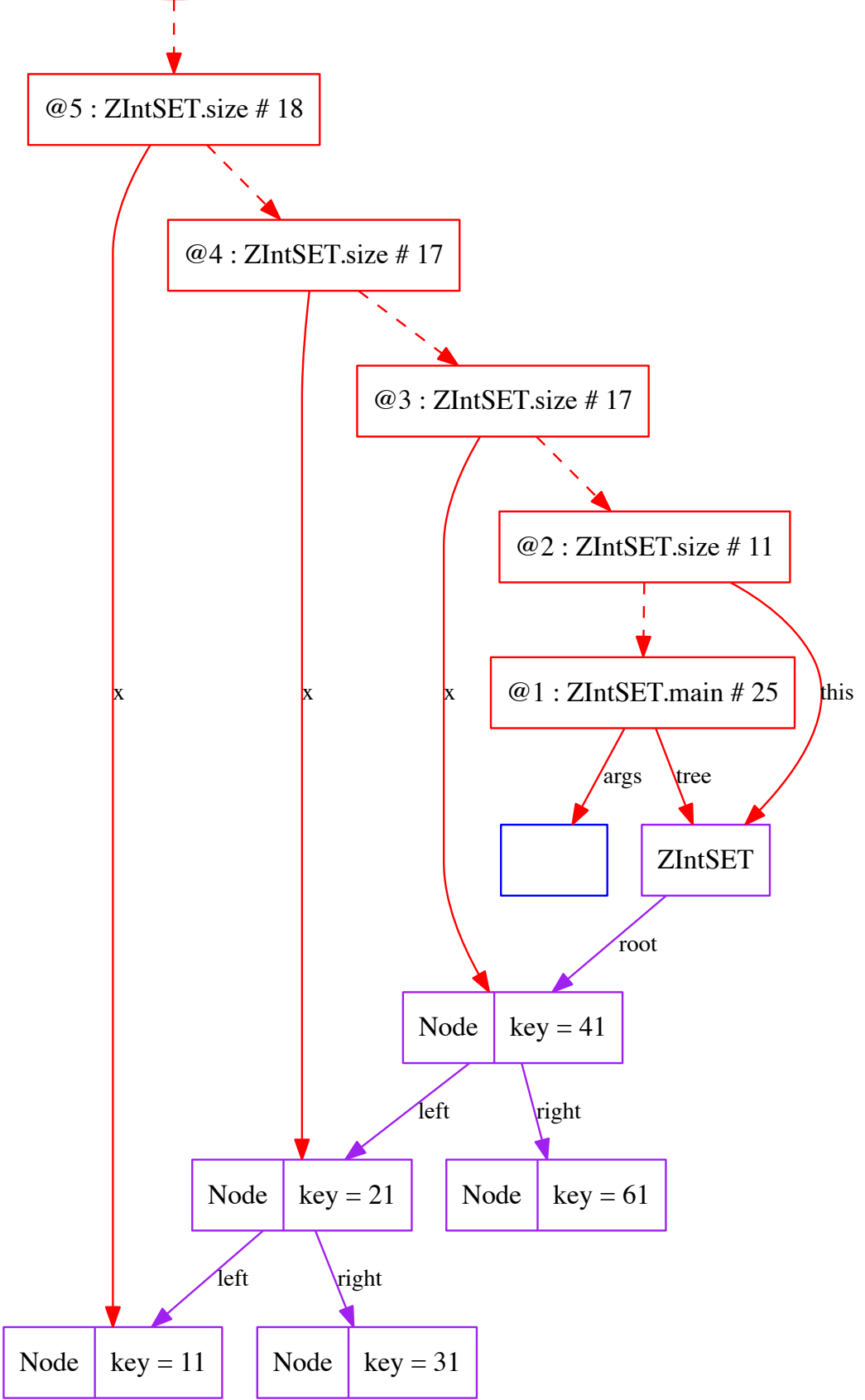

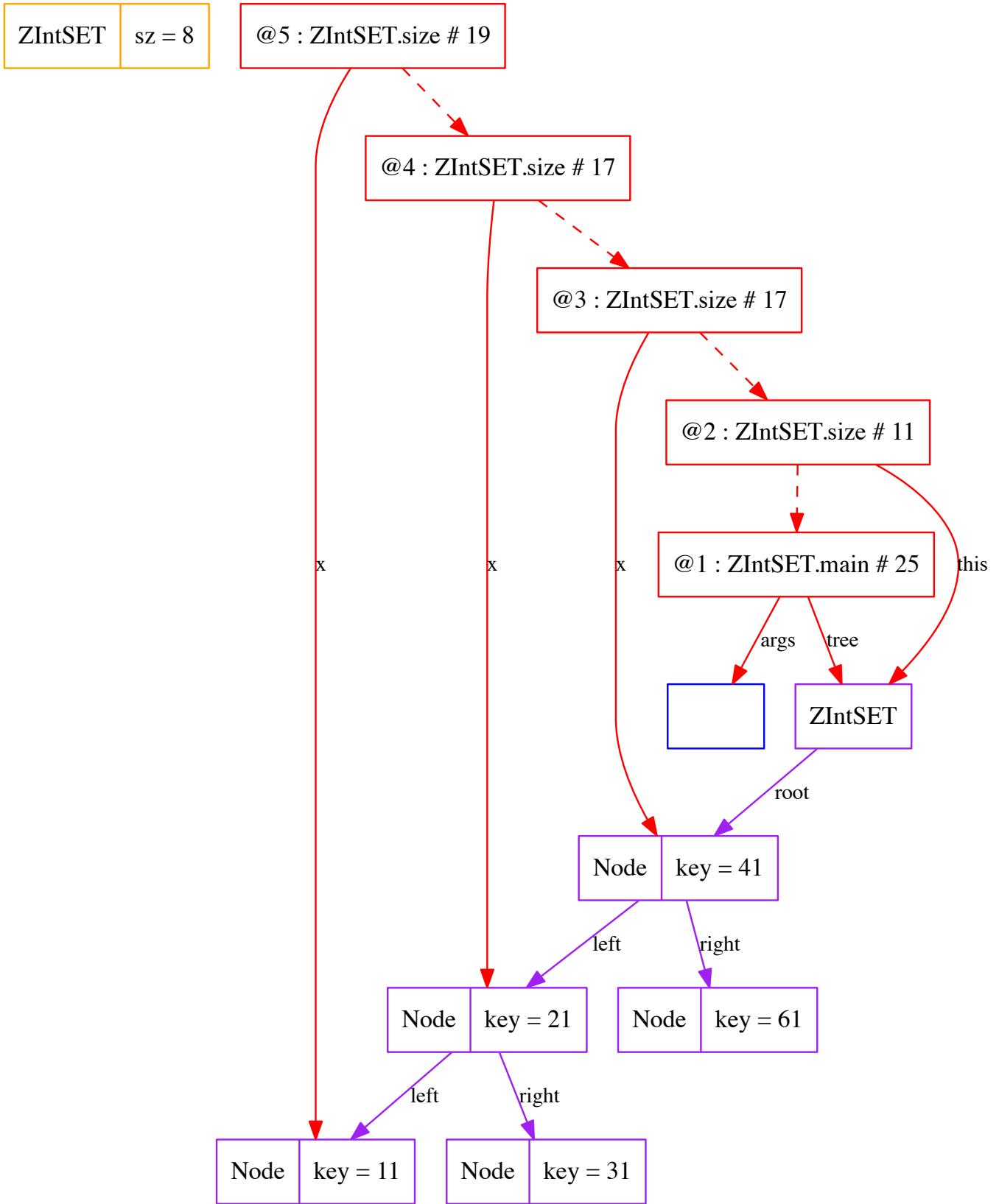

ZIntSET	sz = 8
---------	--------

@5 : returnValue = 8

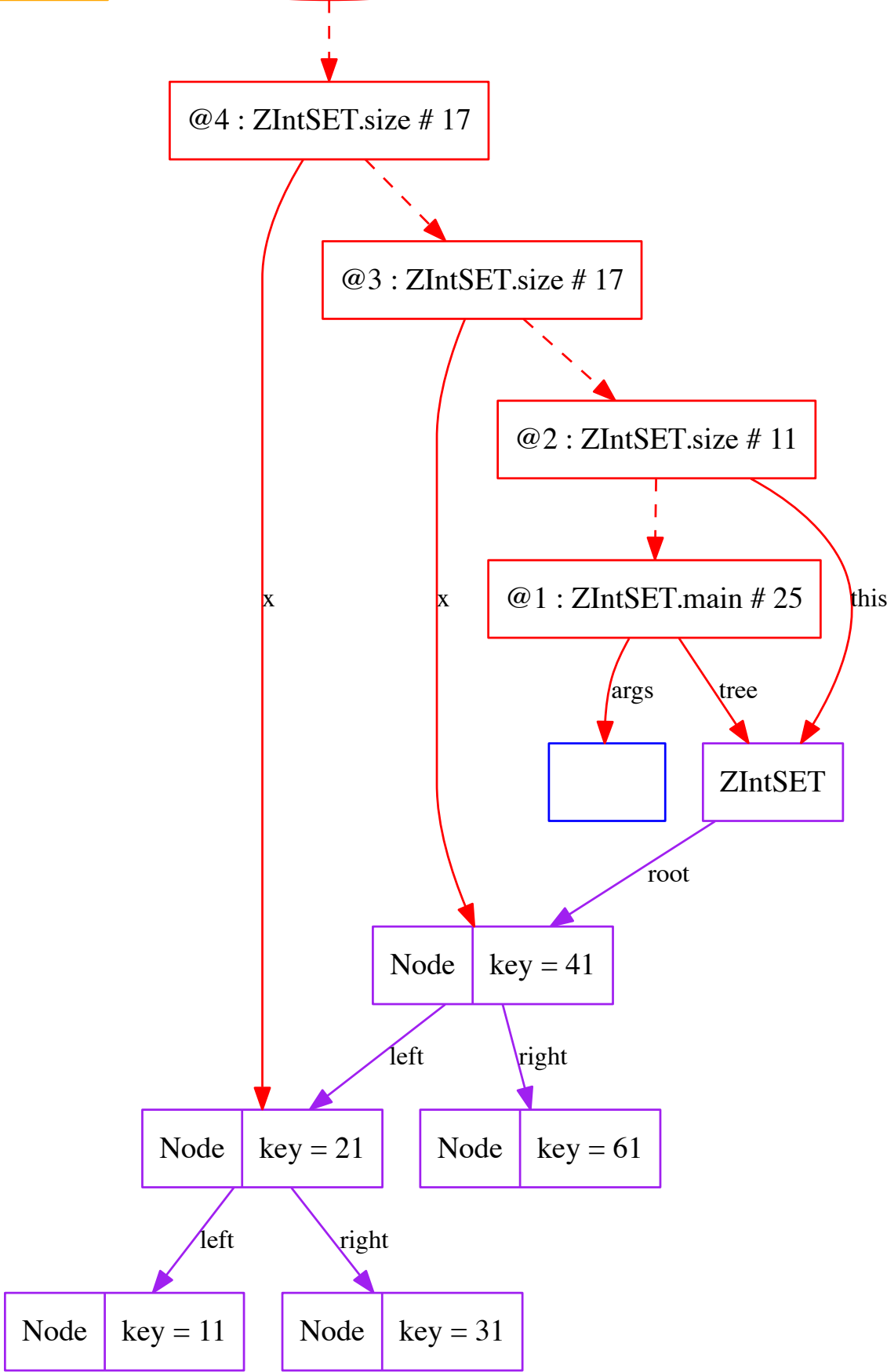

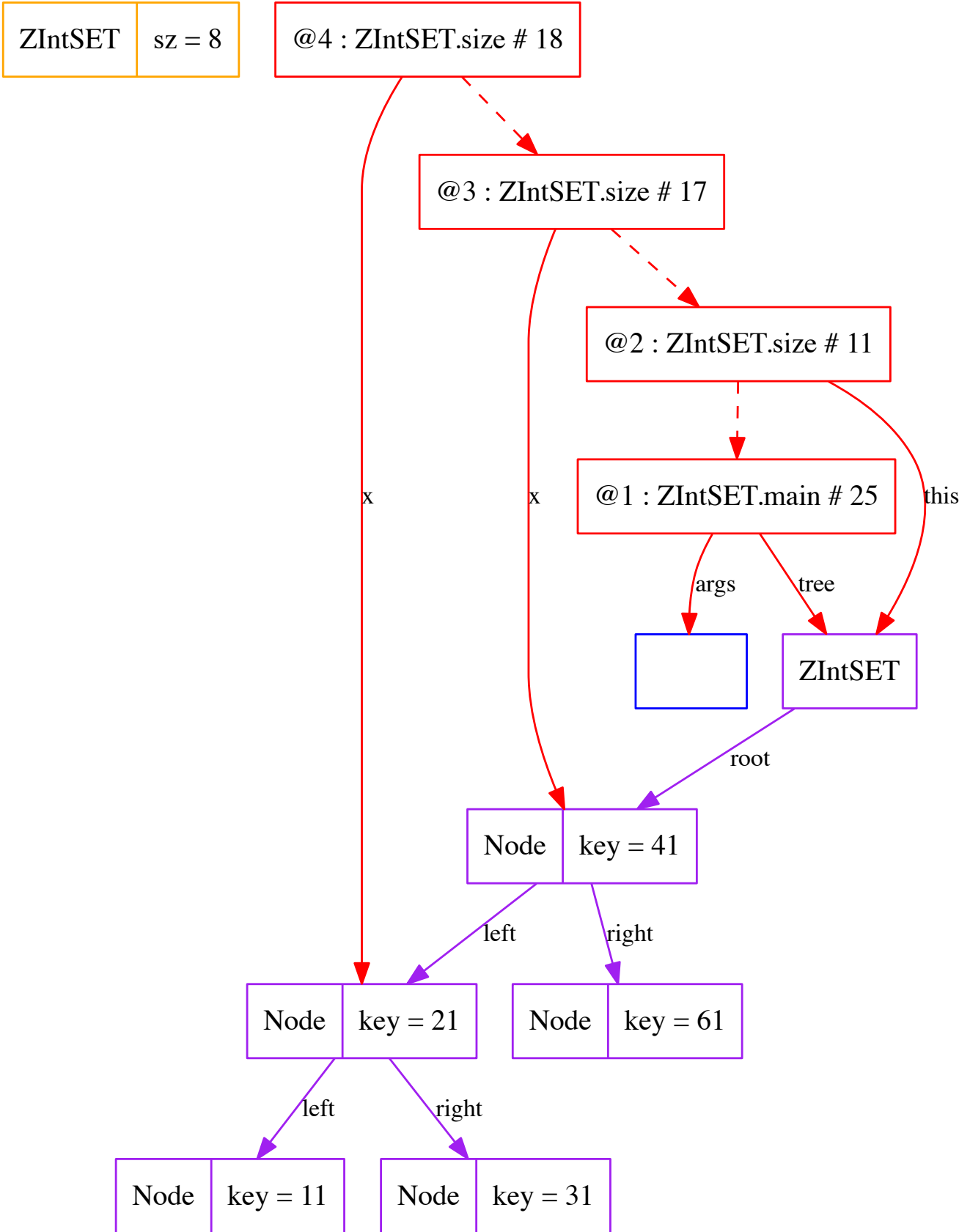

ZIntSET	sz = 8
---------	--------

@5 : ZIntSET.size # 15

@4 : ZIntSET.size # 18

@3 : ZIntSET.size # 17

@2 : ZIntSET.size # 11

@1 : ZIntSET.main # 25

ZIntSET

Node	key = 41
------	----------

Node	key = 21
------	----------

Node	key = 61
------	----------

Node	key = 31
------	----------

Node	key = 11
------	----------

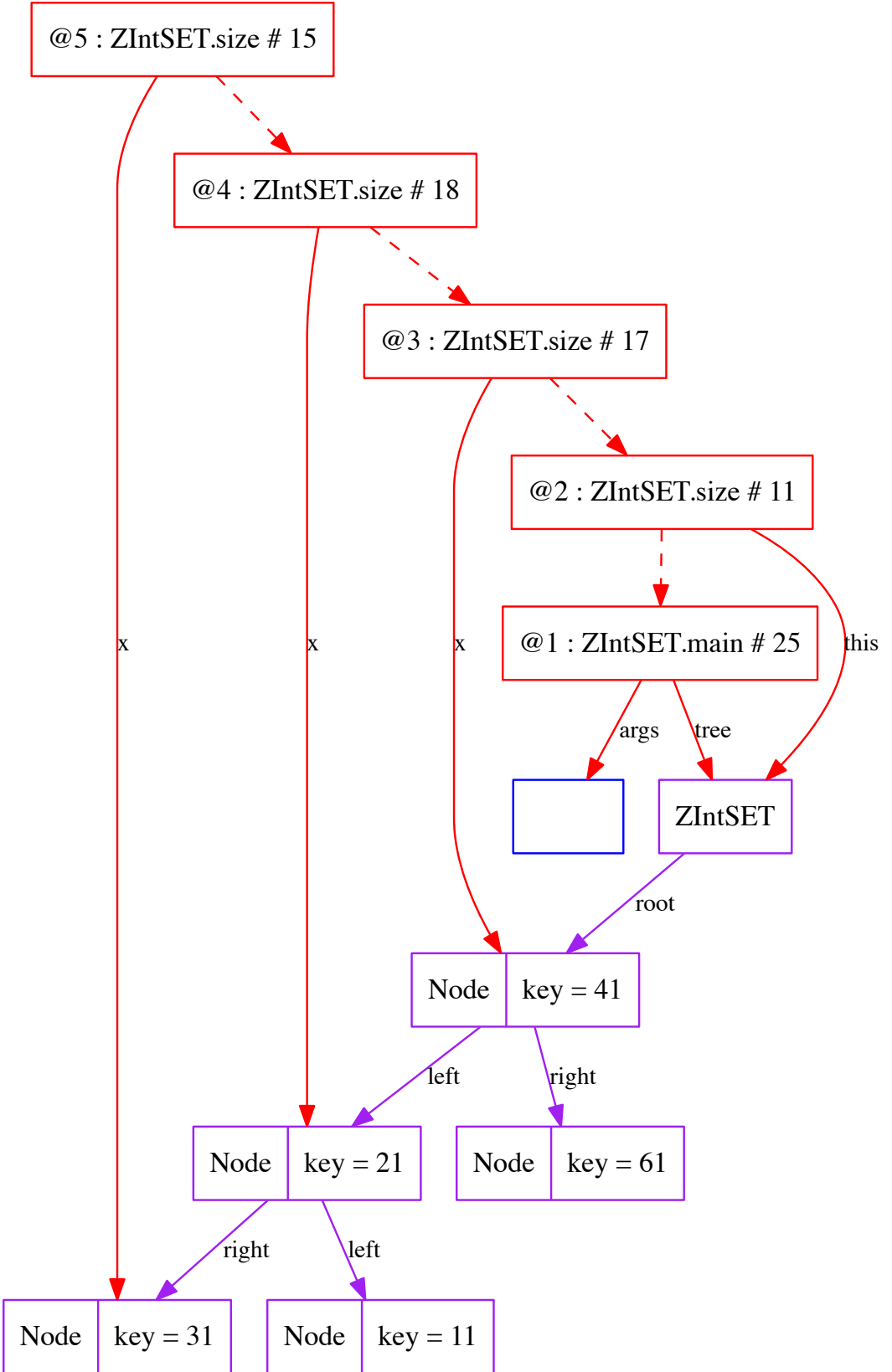

ZIntSET	sz = 8
---------	--------

@5 : ZIntSET.size # 16

@4 : ZIntSET.size # 18

@3 : ZIntSET.size # 17

@2 : ZIntSET.size # 11

@1 : ZIntSET.main # 25

ZIntSET

Node	key = 41
------	----------

Node	key = 21
------	----------

Node	key = 61
------	----------

Node	key = 31
------	----------

Node	key = 11
------	----------

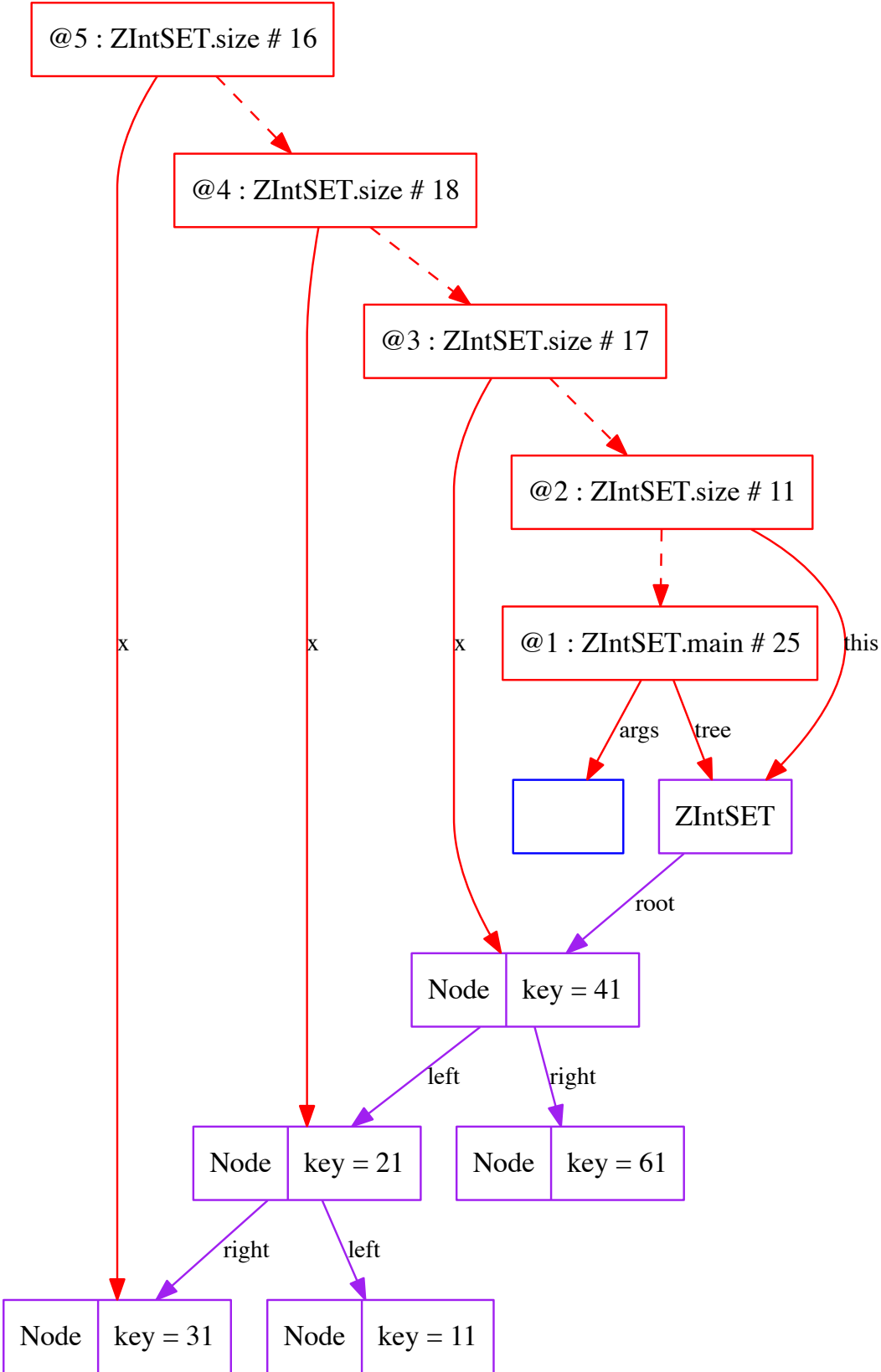

ZIntSET	sz = 9
---------	--------

@5 : ZIntSET.size # 17

@4 : ZIntSET.size # 18

@3 : ZIntSET.size # 17

@2 : ZIntSET.size # 11

@1 : ZIntSET.main # 25

ZIntSET

Node	key = 41
------	----------

Node	key = 21
------	----------

Node	key = 61
------	----------

Node	key = 31
------	----------

Node	key = 11
------	----------

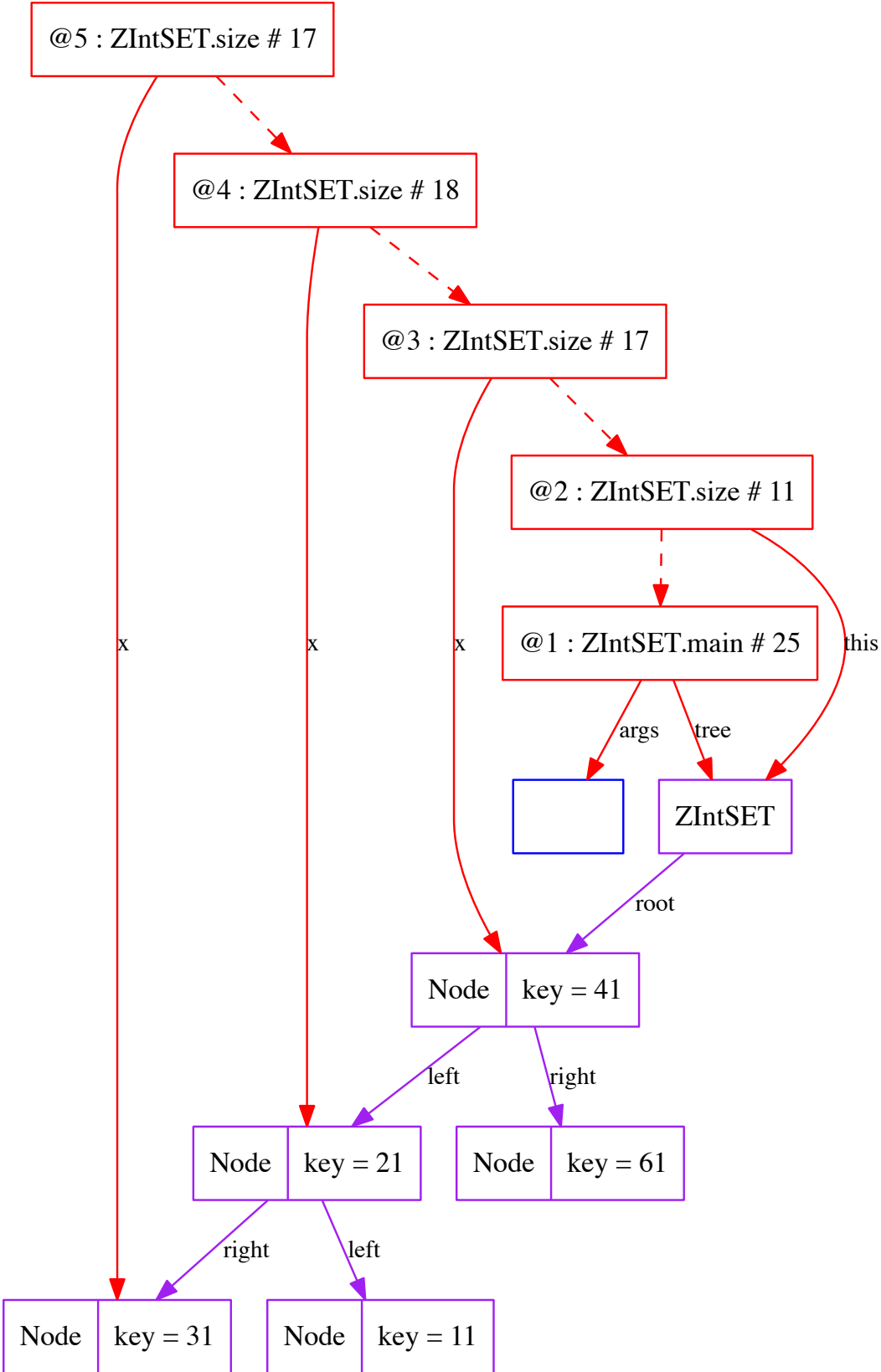

ZIntSET	sz = 9
---------	--------

@6 : ZIntSET.size # 15	x = null
------------------------	----------

@5 : ZIntSET.size # 17

@4 : ZIntSET.size # 18

@3 : ZIntSET.size # 17

@2 : ZIntSET.size # 11

@1 : ZIntSET.main # 25

--

ZIntSET

Node	key = 41
------	----------

Node	key = 21
------	----------

Node	key = 61
------	----------

Node	key = 31
------	----------

Node	key = 11
------	----------

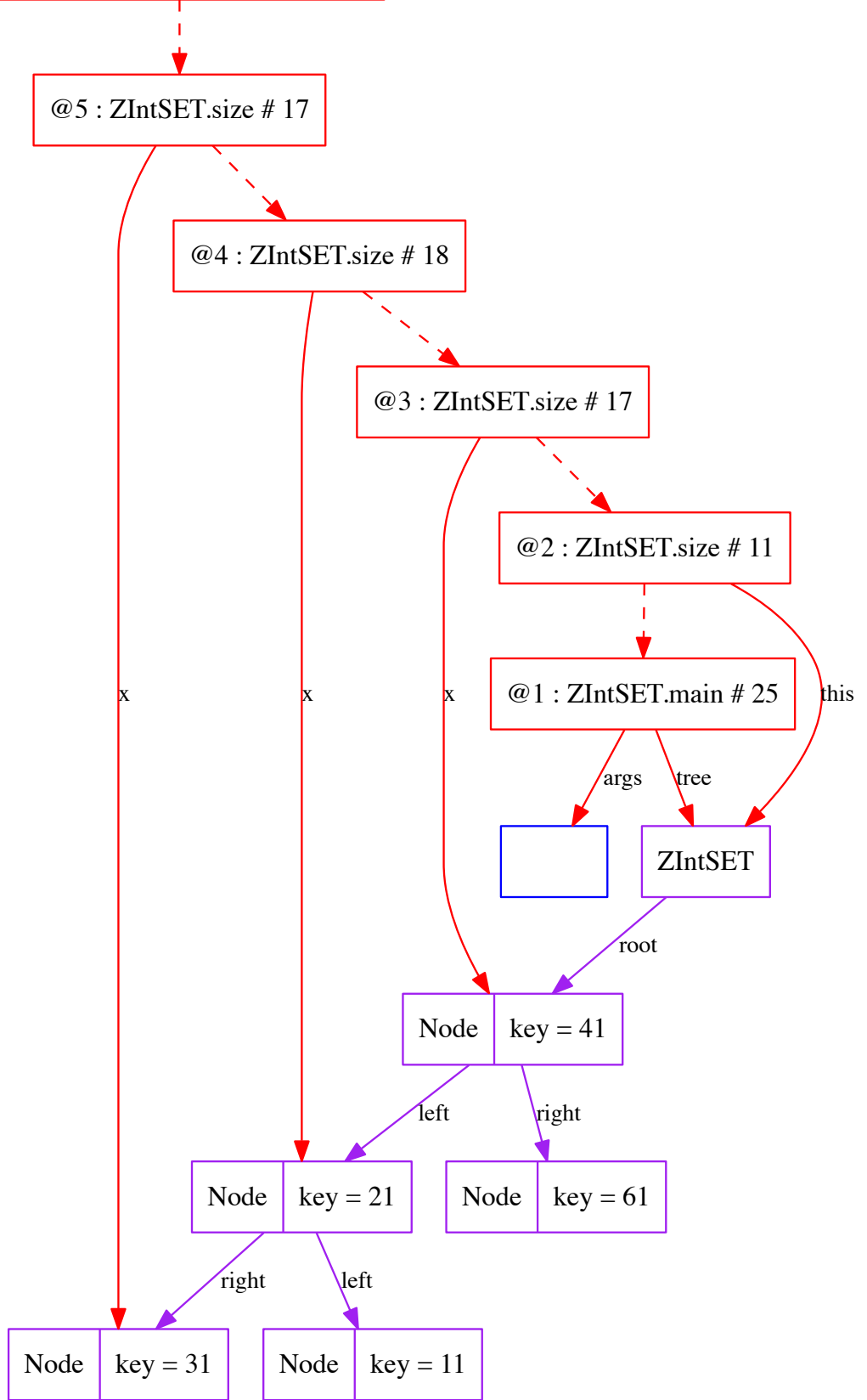

ZIntSET	sz = 9
---------	--------

@6 : returnValue = 9

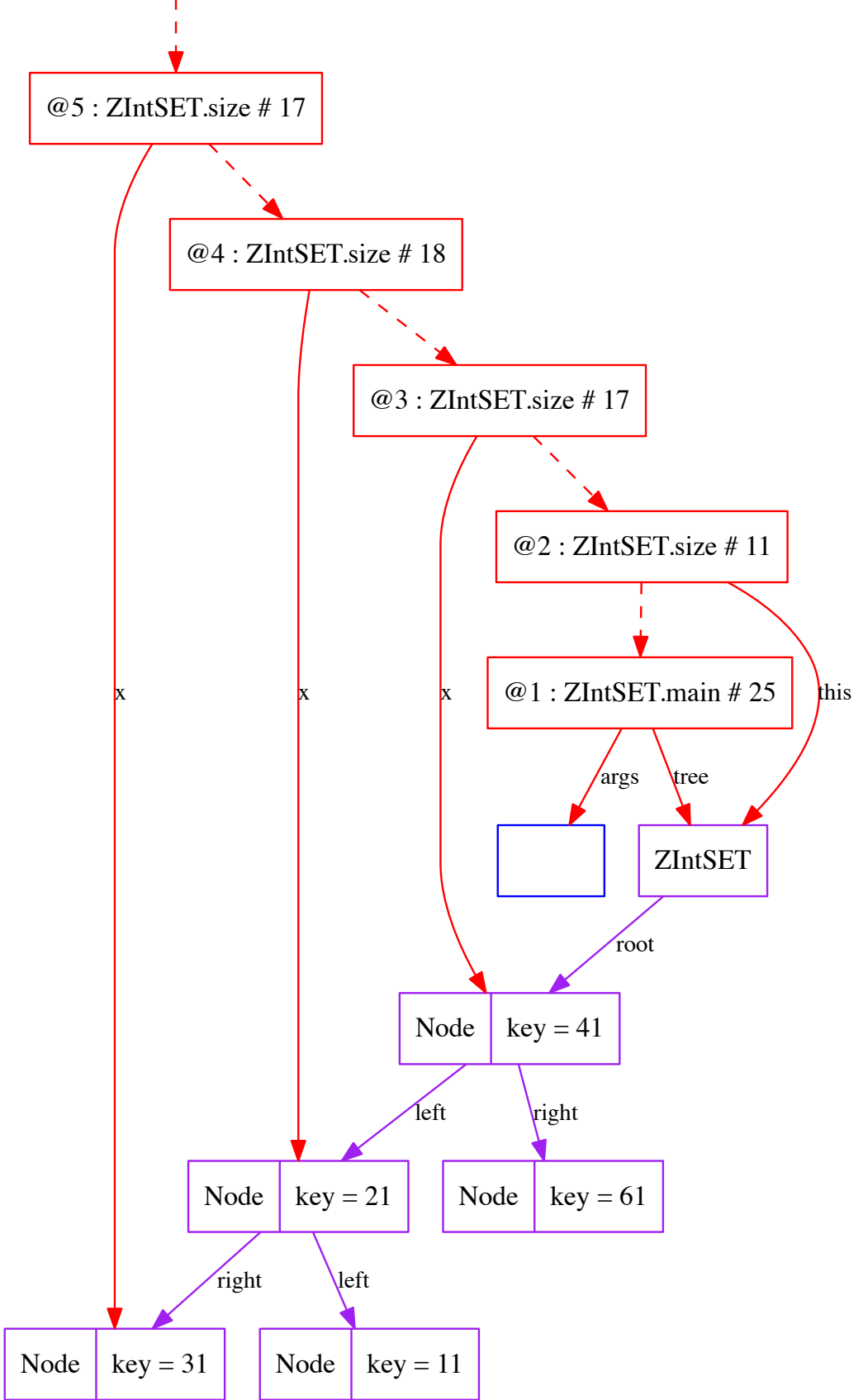

ZIntSET	sz = 9
---------	--------

@5 : ZIntSET.size # 18

@4 : ZIntSET.size # 18

@3 : ZIntSET.size # 17

@2 : ZIntSET.size # 11

@1 : ZIntSET.main # 25

--

ZIntSET

Node	key = 41
------	----------

Node	key = 21
------	----------

Node	key = 61
------	----------

Node	key = 31
------	----------

Node	key = 11
------	----------

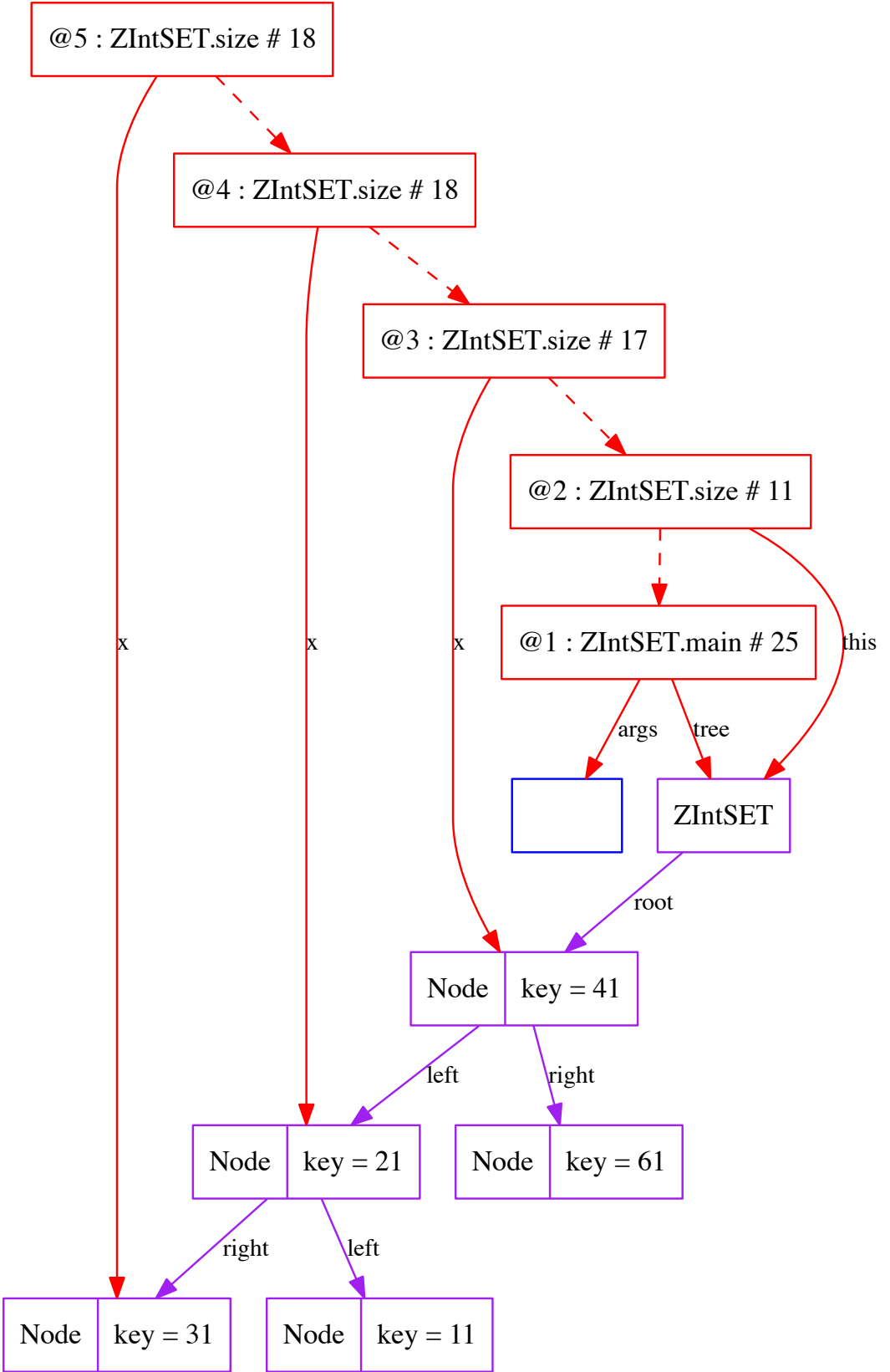

ZIntSET	sz = 9
---------	--------

@6 : ZIntSET.size # 15	x = null
------------------------	----------

@5 : ZIntSET.size # 18

@4 : ZIntSET.size # 18

@3 : ZIntSET.size # 17

@2 : ZIntSET.size # 11

@1 : ZIntSET.main # 25

--

ZIntSET

Node	key = 41
------	----------

Node	key = 21
------	----------

Node	key = 61
------	----------

Node	key = 31
------	----------

Node	key = 11
------	----------

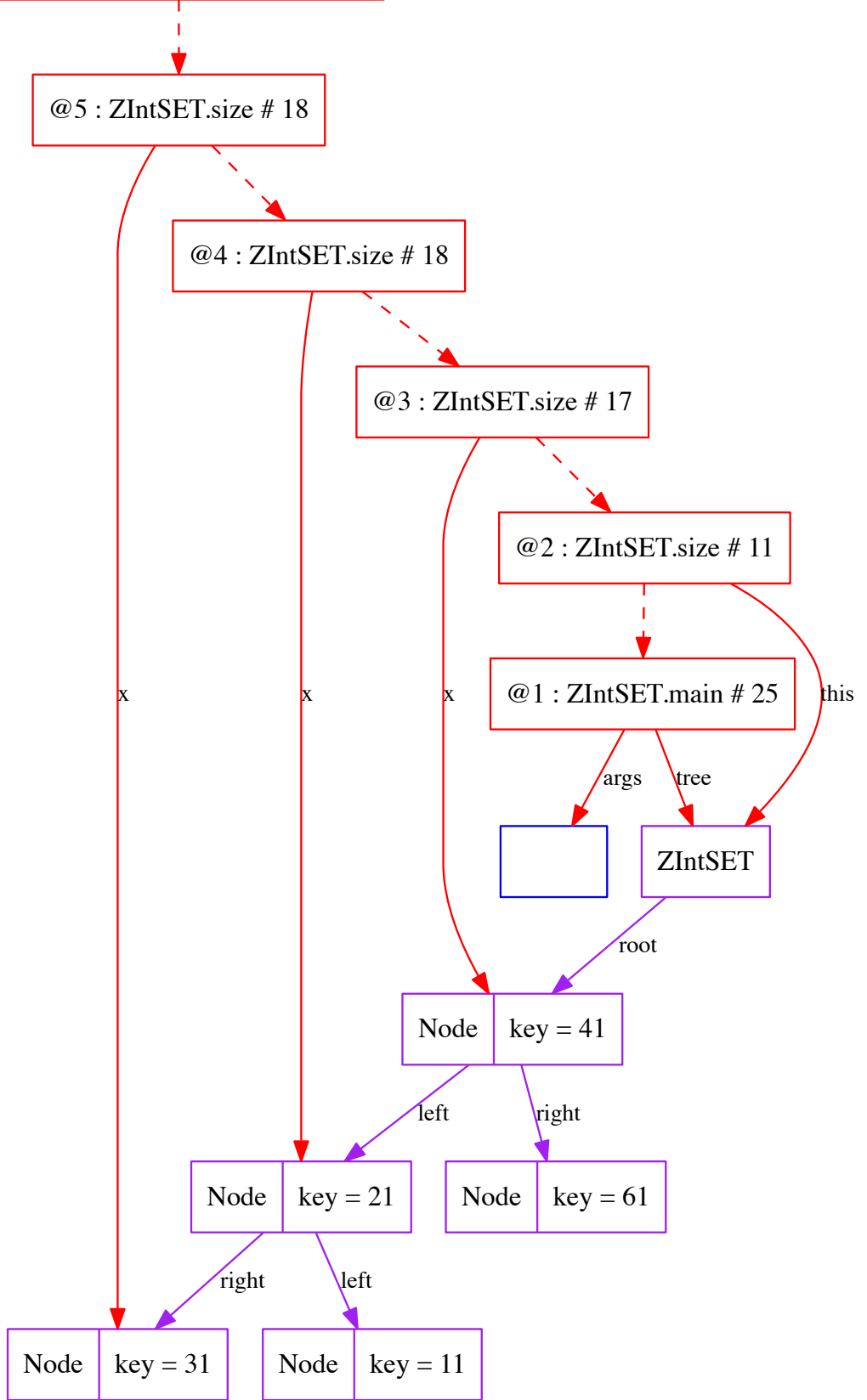

ZIntSET	sz = 9
---------	--------

@6 : returnValue = 9

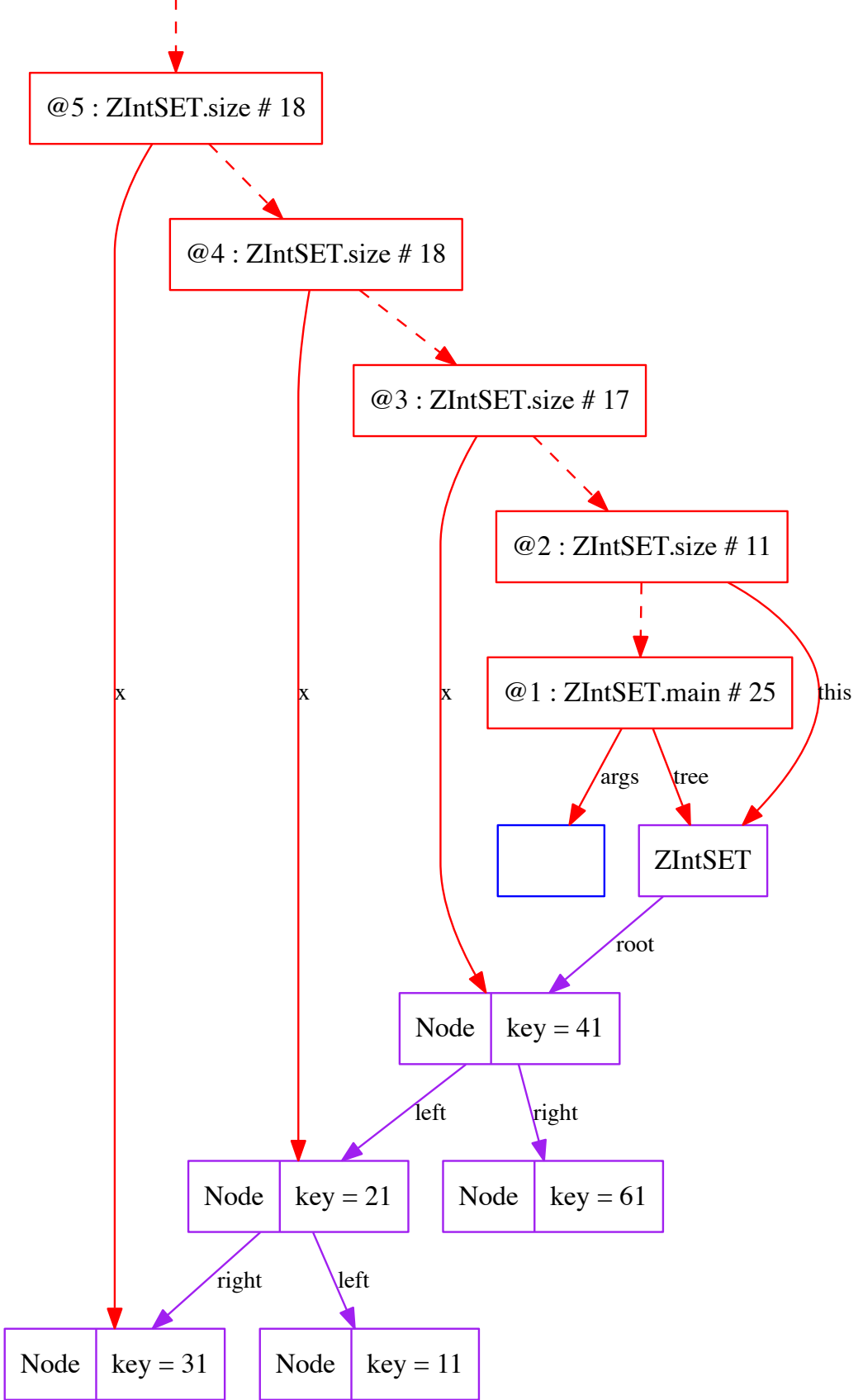

ZIntSET	sz = 9
---------	--------

@5 : ZIntSET.size # 19

@4 : ZIntSET.size # 18

@3 : ZIntSET.size # 17

@2 : ZIntSET.size # 11

@1 : ZIntSET.main # 25

ZIntSET

Node	key = 41
------	----------

Node	key = 21
------	----------

Node	key = 61
------	----------

Node	key = 31
------	----------

Node	key = 11
------	----------

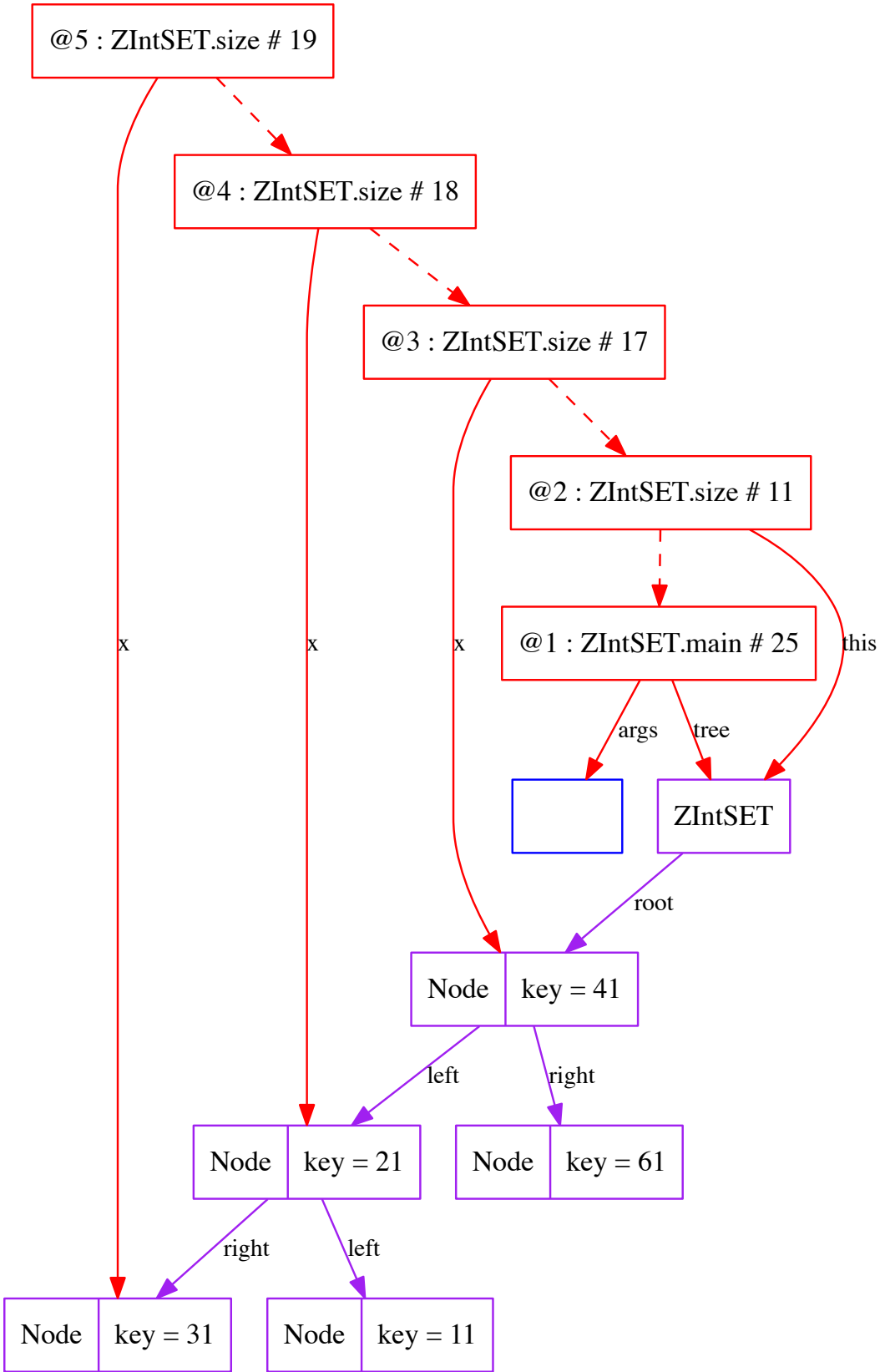

ZIntSET	sz = 9
---------	--------

@5 : returnValue = 9

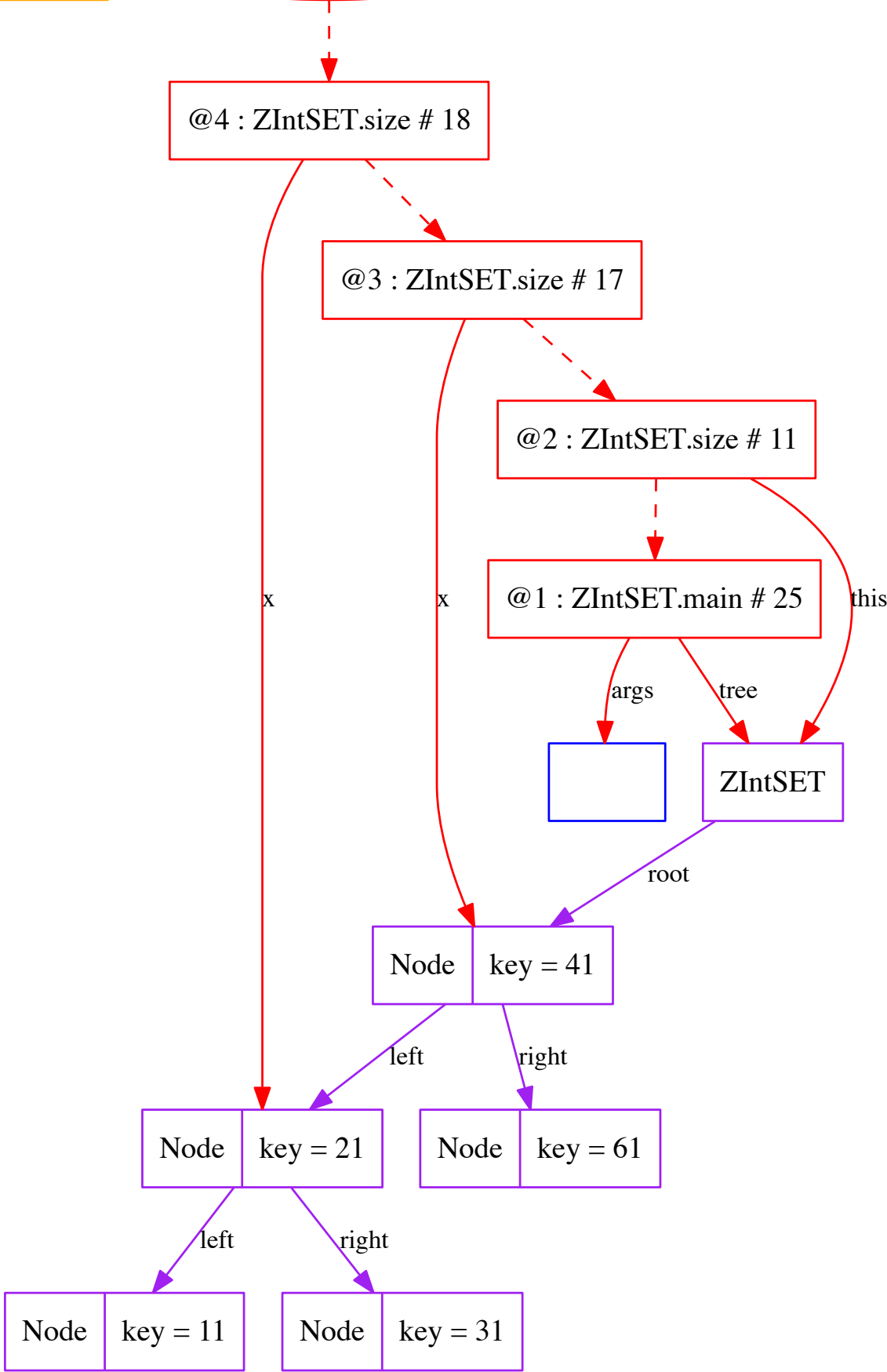

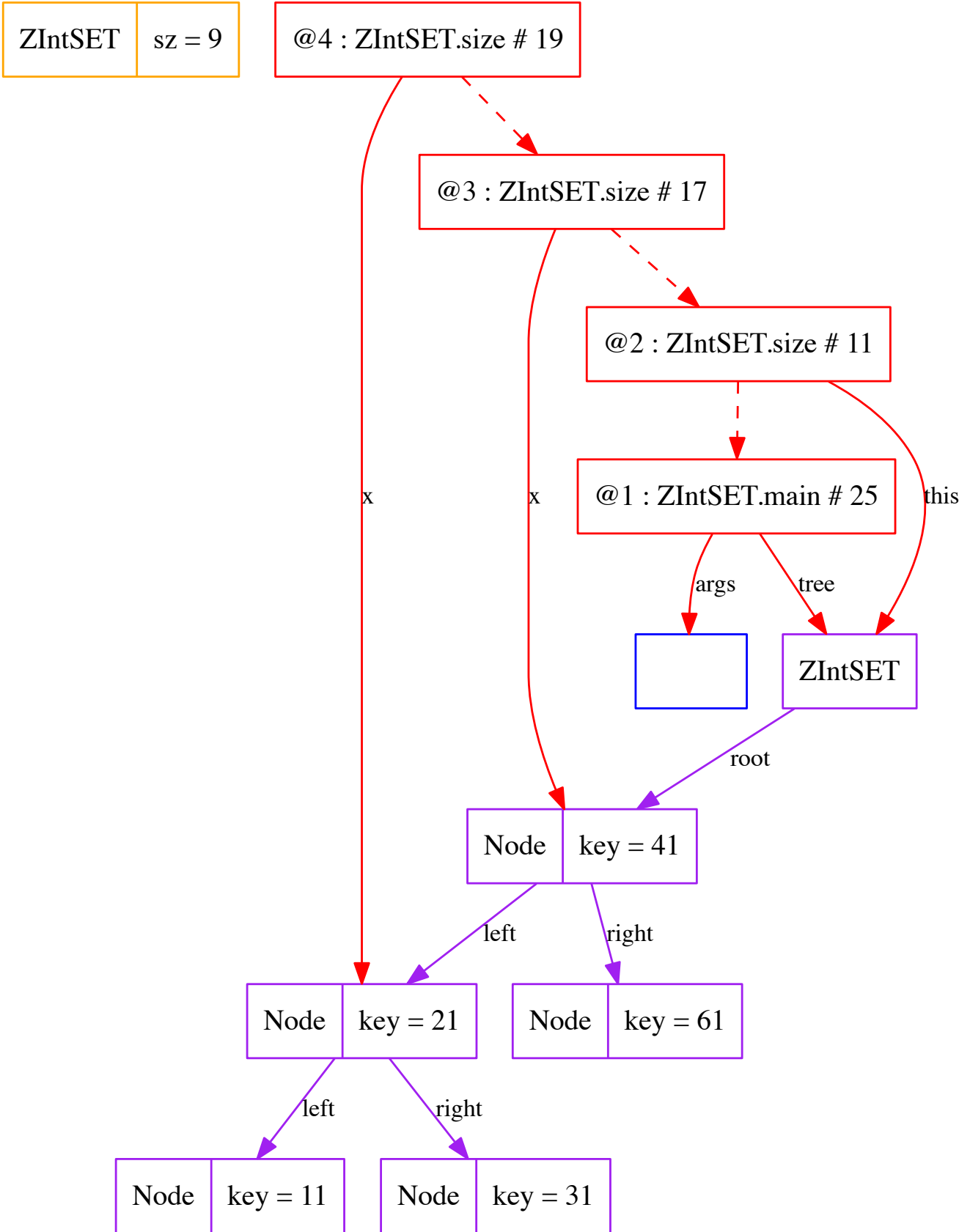

ZIntSET	sz = 9
---------	--------

@3 : ZIntSET.size # 18

@2 : ZIntSET.size # 11

@1 : ZIntSET.main # 25

--

ZIntSET

Node	key = 41
------	----------

Node	key = 21
------	----------

Node	key = 61
------	----------

Node	key = 11
------	----------

Node	key = 31
------	----------

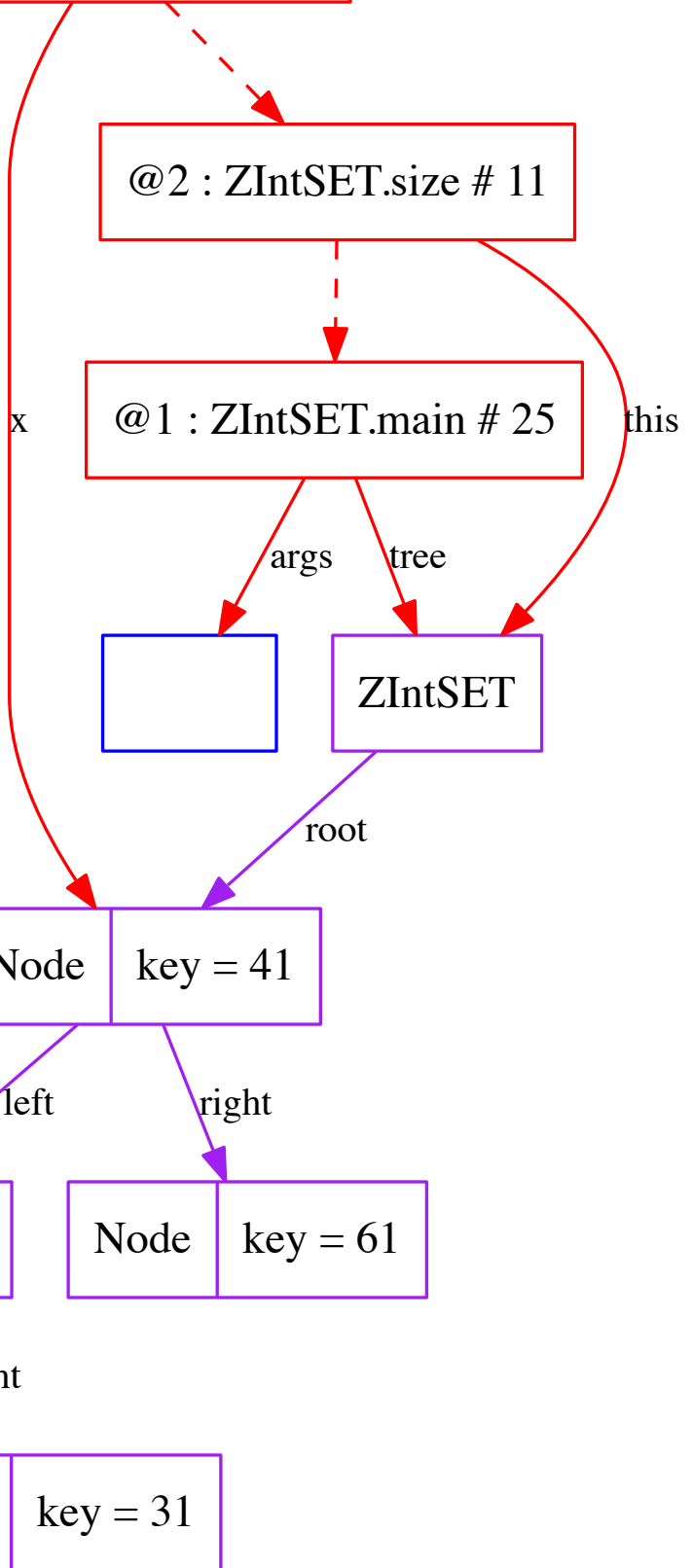

ZIntSET	sz = 9
---------	--------

@4 : ZIntSET.size # 15

@3 : ZIntSET.size # 18

@2 : ZIntSET.size # 11

@1 : ZIntSET.main # 25

ZIntSET

Node	key = 41
------	----------

Node	key = 61
------	----------

Node	key = 21
------	----------

Node	key = 11
------	----------

Node	key = 31
------	----------

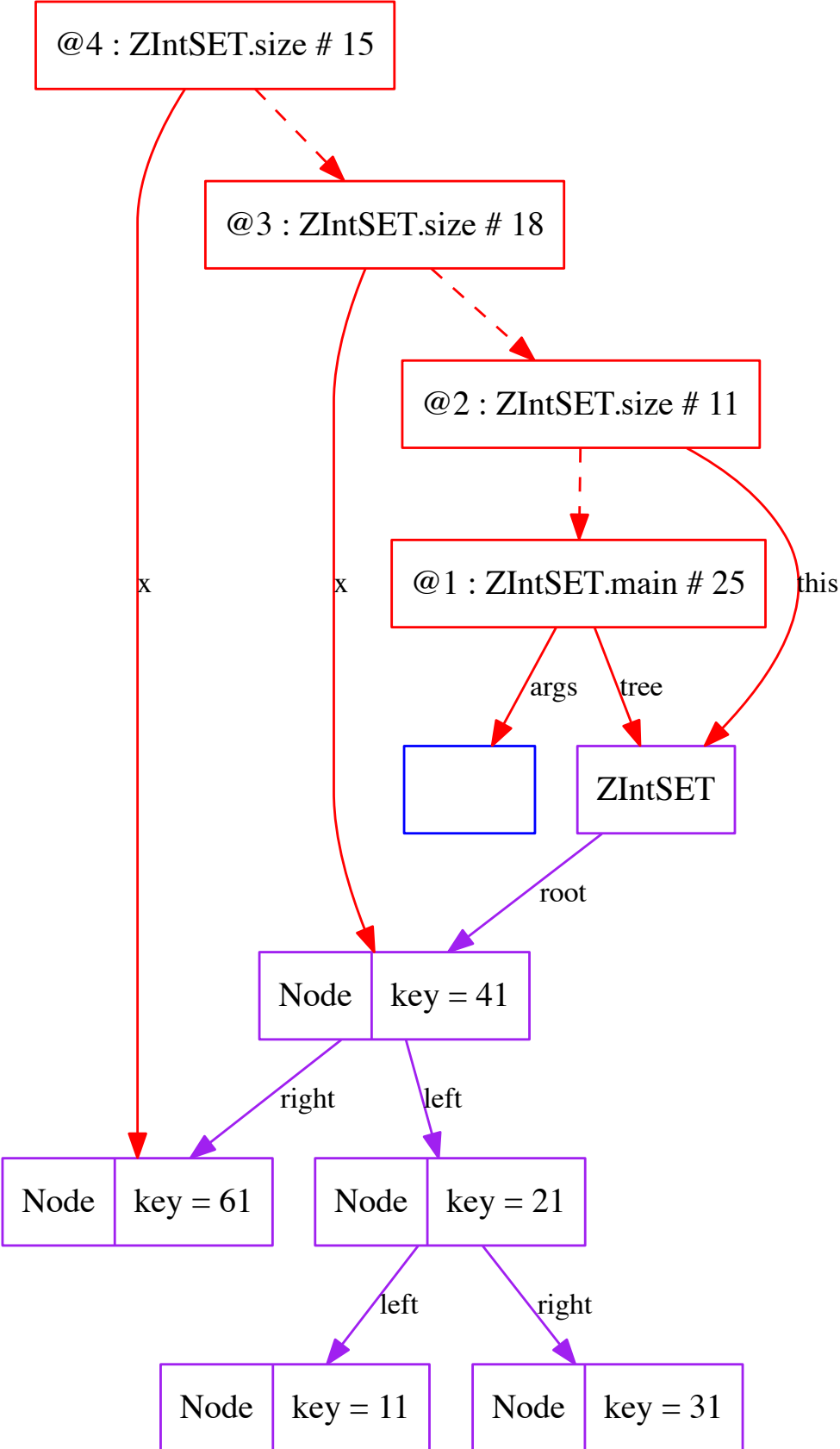

ZIntSET	sz = 9
---------	--------

@4 : ZIntSET.size # 16

@3 : ZIntSET.size # 18

@2 : ZIntSET.size # 11

@1 : ZIntSET.main # 25

--

ZIntSET

Node	key = 41
------	----------

Node	key = 61
------	----------

Node	key = 21
------	----------

Node	key = 11
------	----------

Node	key = 31
------	----------

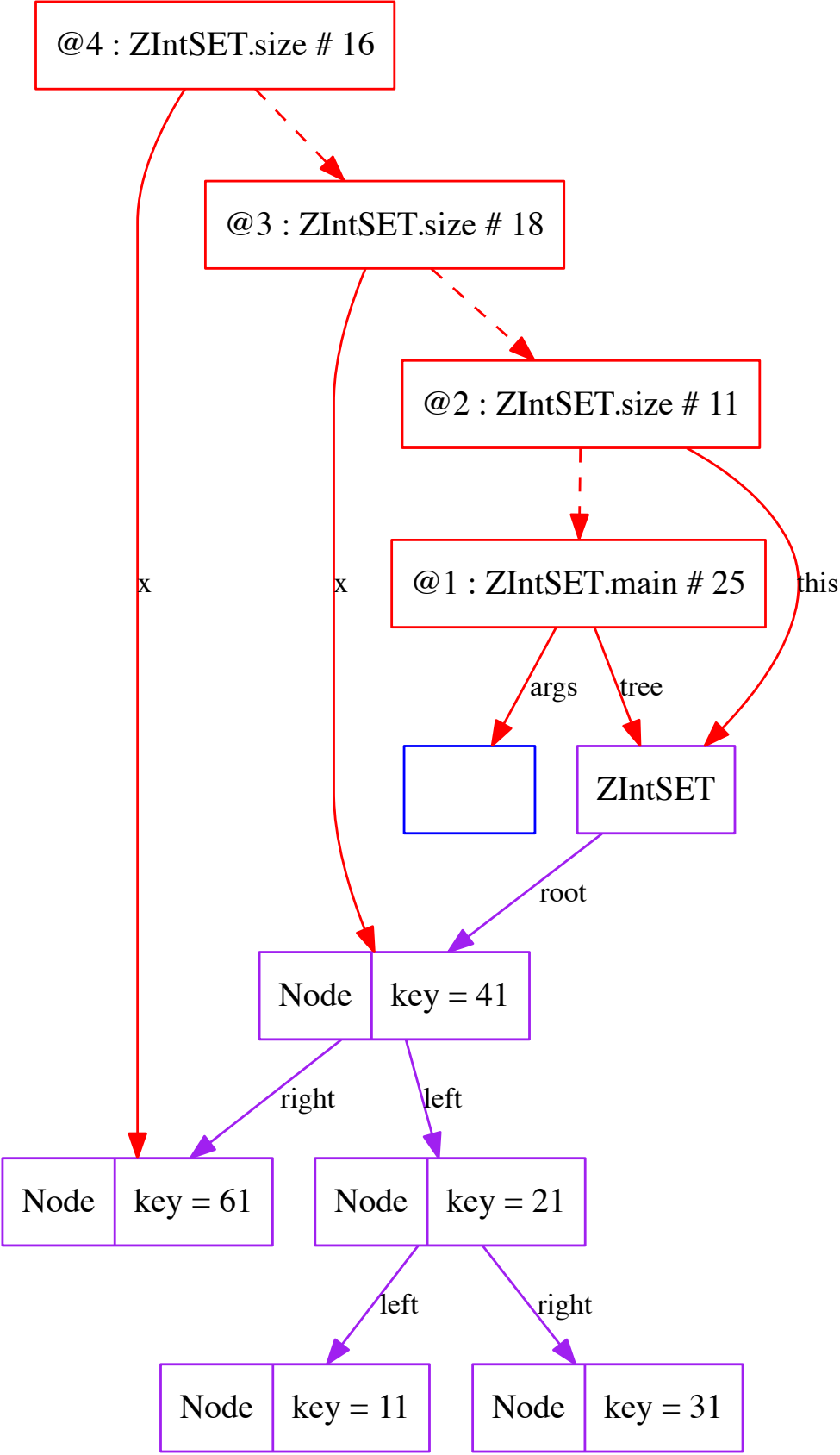

ZIntSET	sz = 10
---------	---------

@4 : ZIntSET.size # 17

@3 : ZIntSET.size # 18

@2 : ZIntSET.size # 11

@1 : ZIntSET.main # 25

--

ZIntSET

Node	key = 41
------	----------

Node	key = 61
------	----------

Node	key = 21
------	----------

Node	key = 11
------	----------

Node	key = 31
------	----------

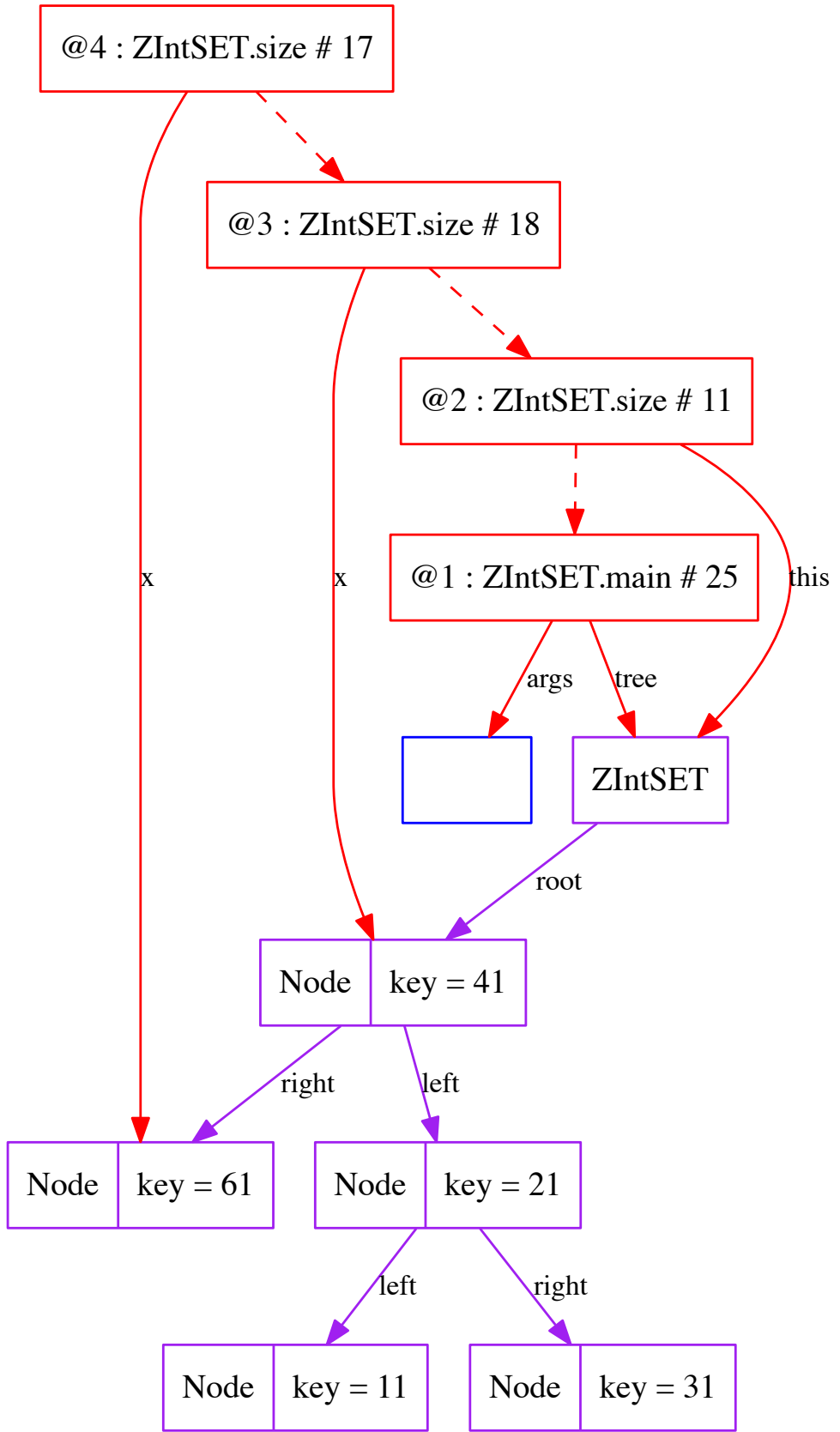

ZIntSET	sz = 10
---------	---------

@5 : ZIntSET.size # 15	x = null
------------------------	----------

@4 : ZIntSET.size # 17

@3 : ZIntSET.size # 18

@2 : ZIntSET.size # 11

@1 : ZIntSET.main # 25

--

ZIntSET

Node	key = 41
------	----------

Node	key = 61
------	----------

Node	key = 21
------	----------

Node	key = 11
------	----------

Node	key = 31
------	----------

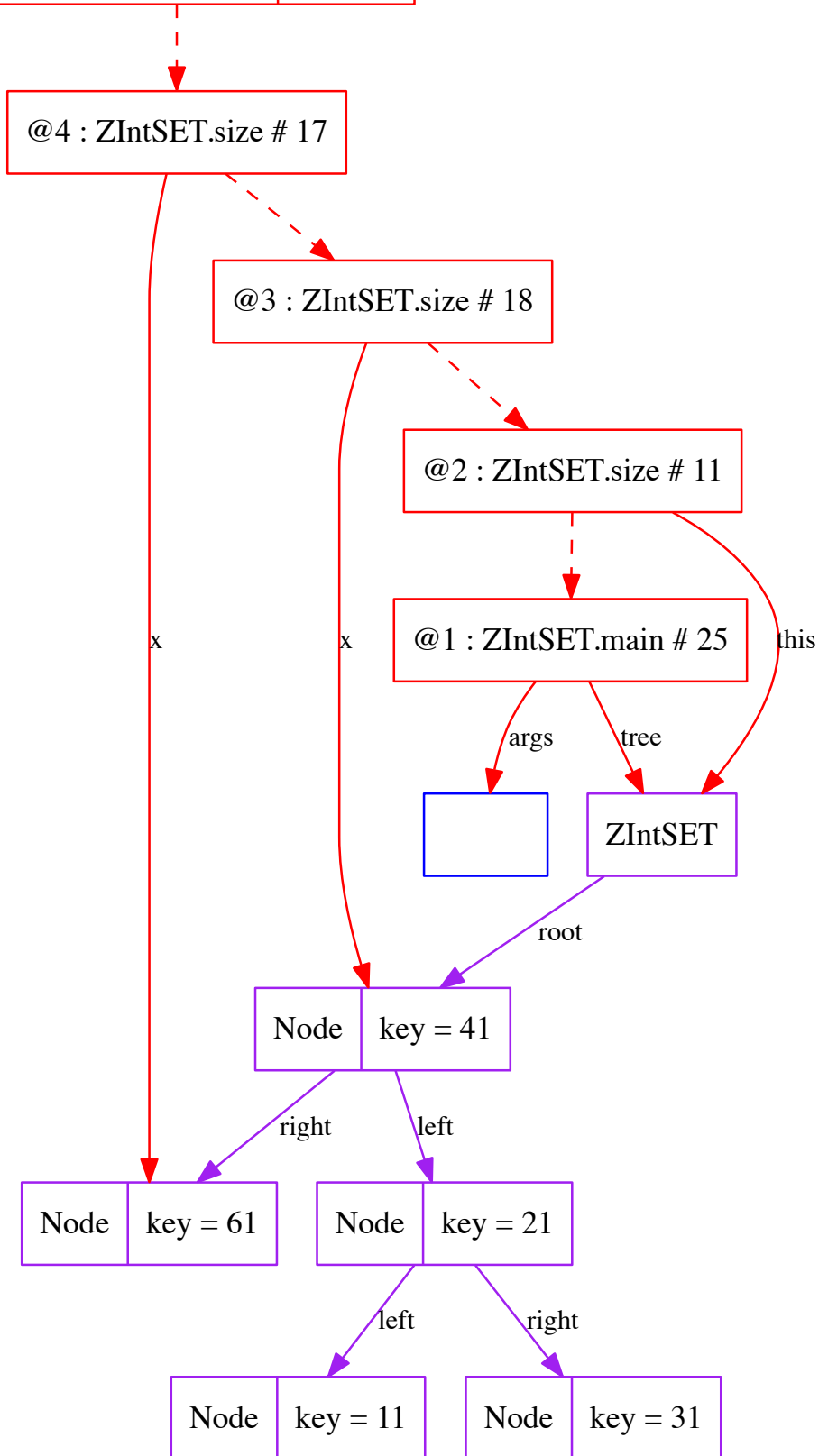

ZIntSET	sz = 10
---------	---------

@5 : returnValue = 10

@4 : ZIntSET.size # 17

@3 : ZIntSET.size # 18

@2 : ZIntSET.size # 11

@1 : ZIntSET.main # 25

ZIntSET

Node key = 41

Node key = 61

Node key = 21

Node key = 11

Node key = 31

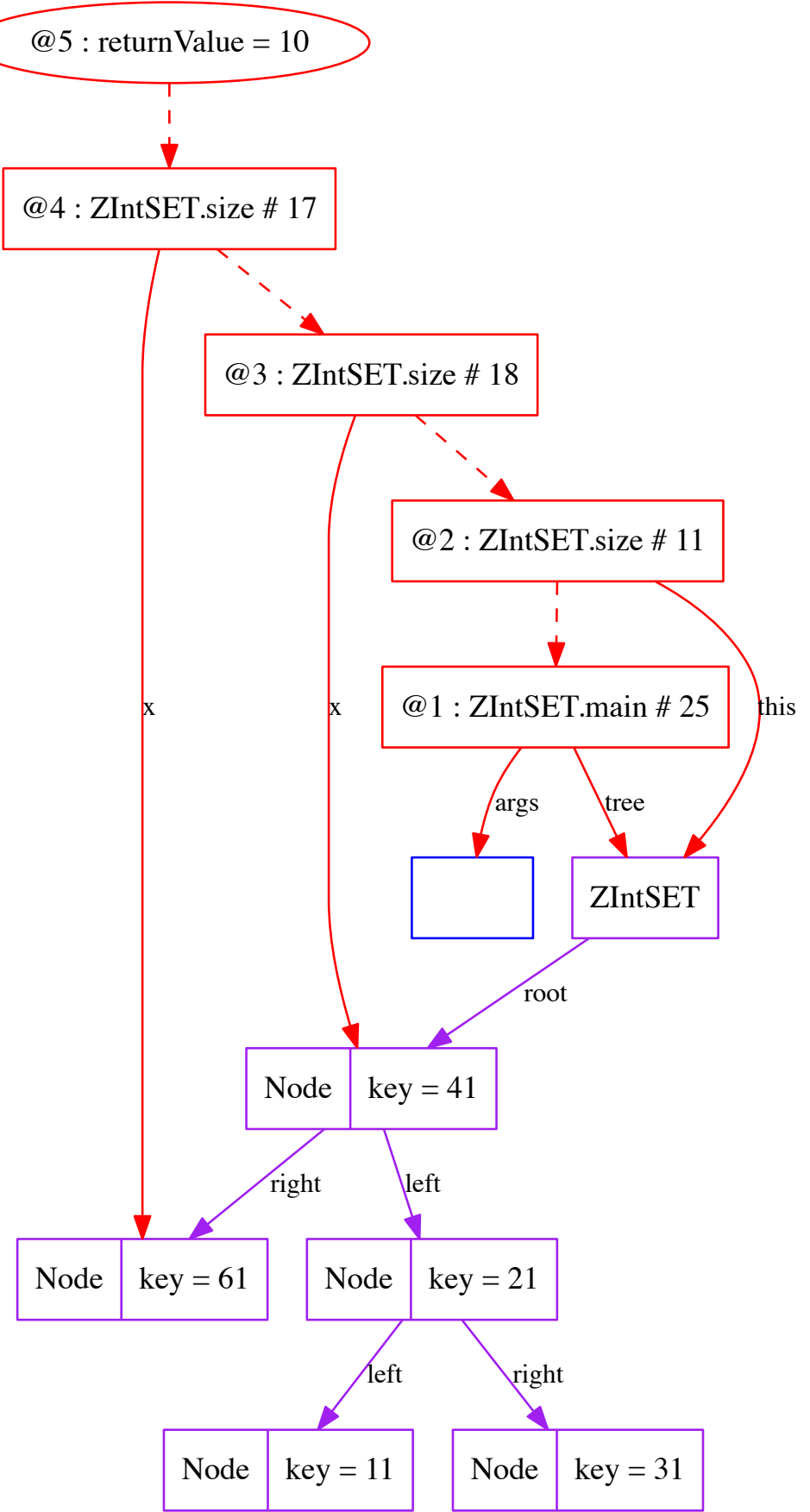

ZIntSET	sz = 10
---------	---------

@4 : ZIntSET.size # 18

@3 : ZIntSET.size # 18

@2 : ZIntSET.size # 11

@1 : ZIntSET.main # 25

--

ZIntSET

Node	key = 41
------	----------

Node	key = 61
------	----------

Node	key = 21
------	----------

Node	key = 11
------	----------

Node	key = 31
------	----------

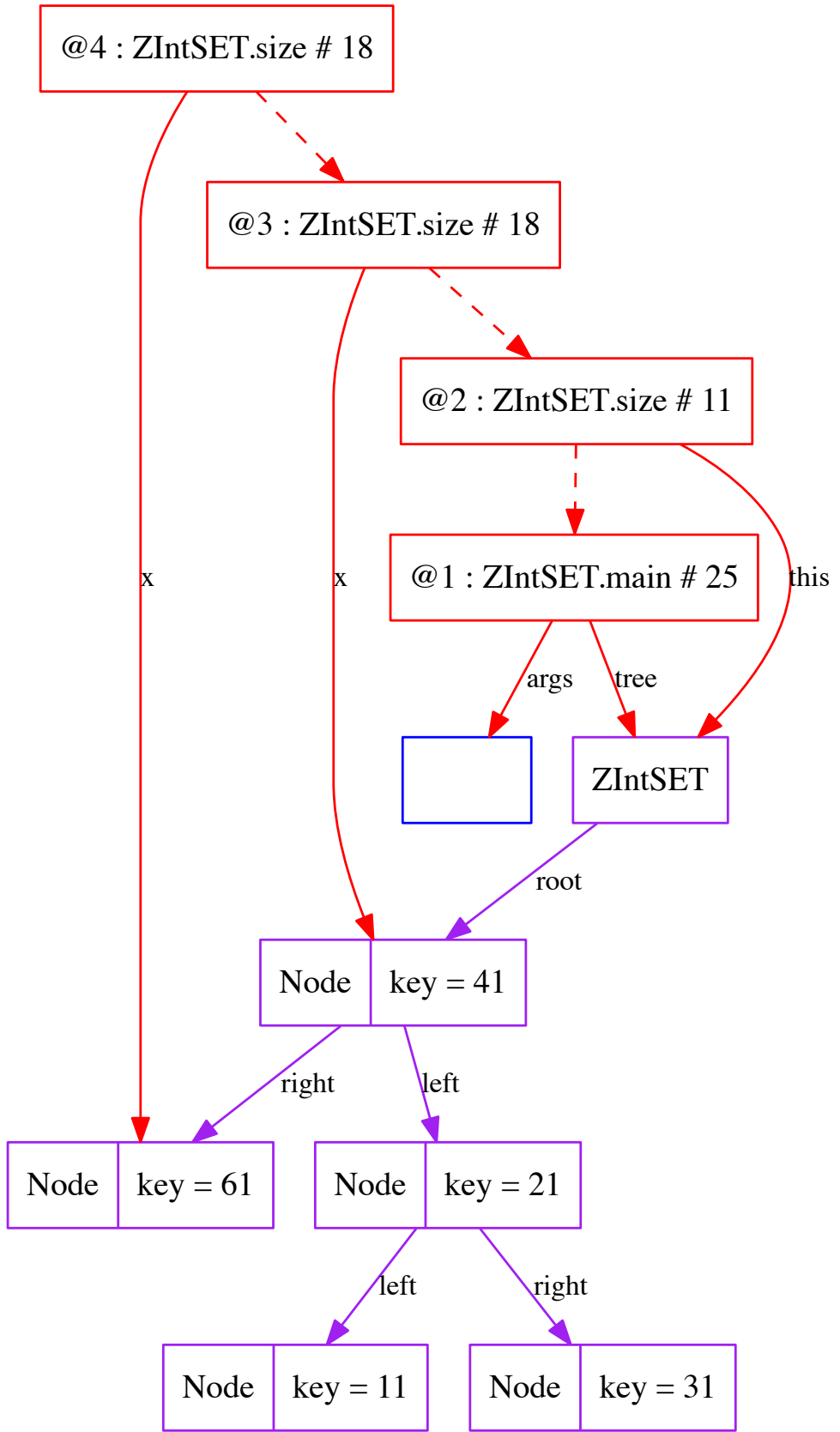

ZIntSET	sz = 10
---------	---------

@5 : ZIntSET.size # 15	x = null
------------------------	----------

@4 : ZIntSET.size # 18

@3 : ZIntSET.size # 18

@2 : ZIntSET.size # 11

@1 : ZIntSET.main # 25

--

ZIntSET

Node	key = 41
------	----------

Node	key = 61
------	----------

Node	key = 21
------	----------

Node	key = 11
------	----------

Node	key = 31
------	----------

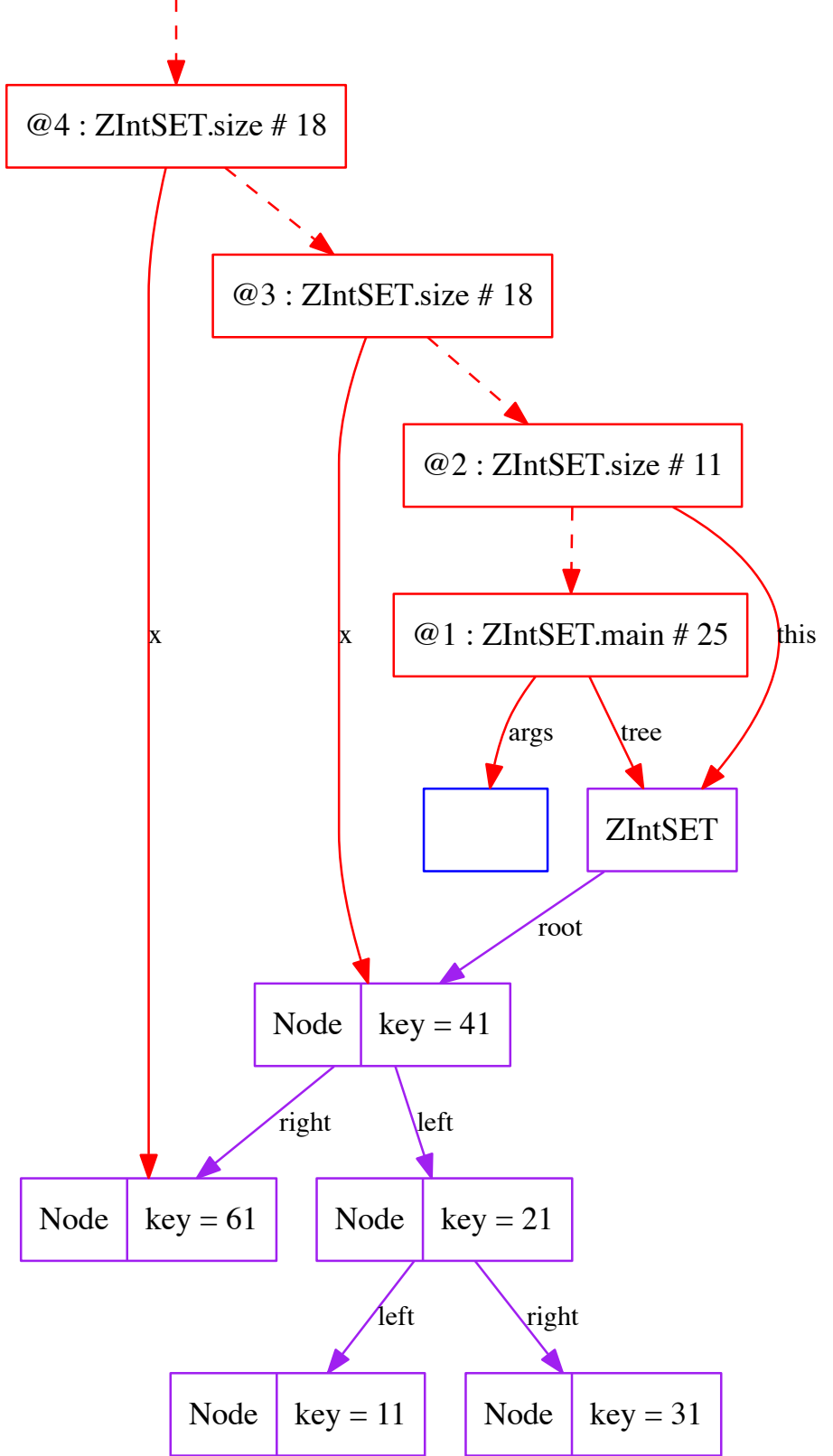

ZIntSET	sz = 10
---------	---------

@5 : returnValue = 10

@4 : ZIntSET.size # 18

@3 : ZIntSET.size # 18

@2 : ZIntSET.size # 11

@1 : ZIntSET.main # 25

ZIntSET

Node key = 41

Node key = 61

Node key = 21

Node key = 11

Node key = 31

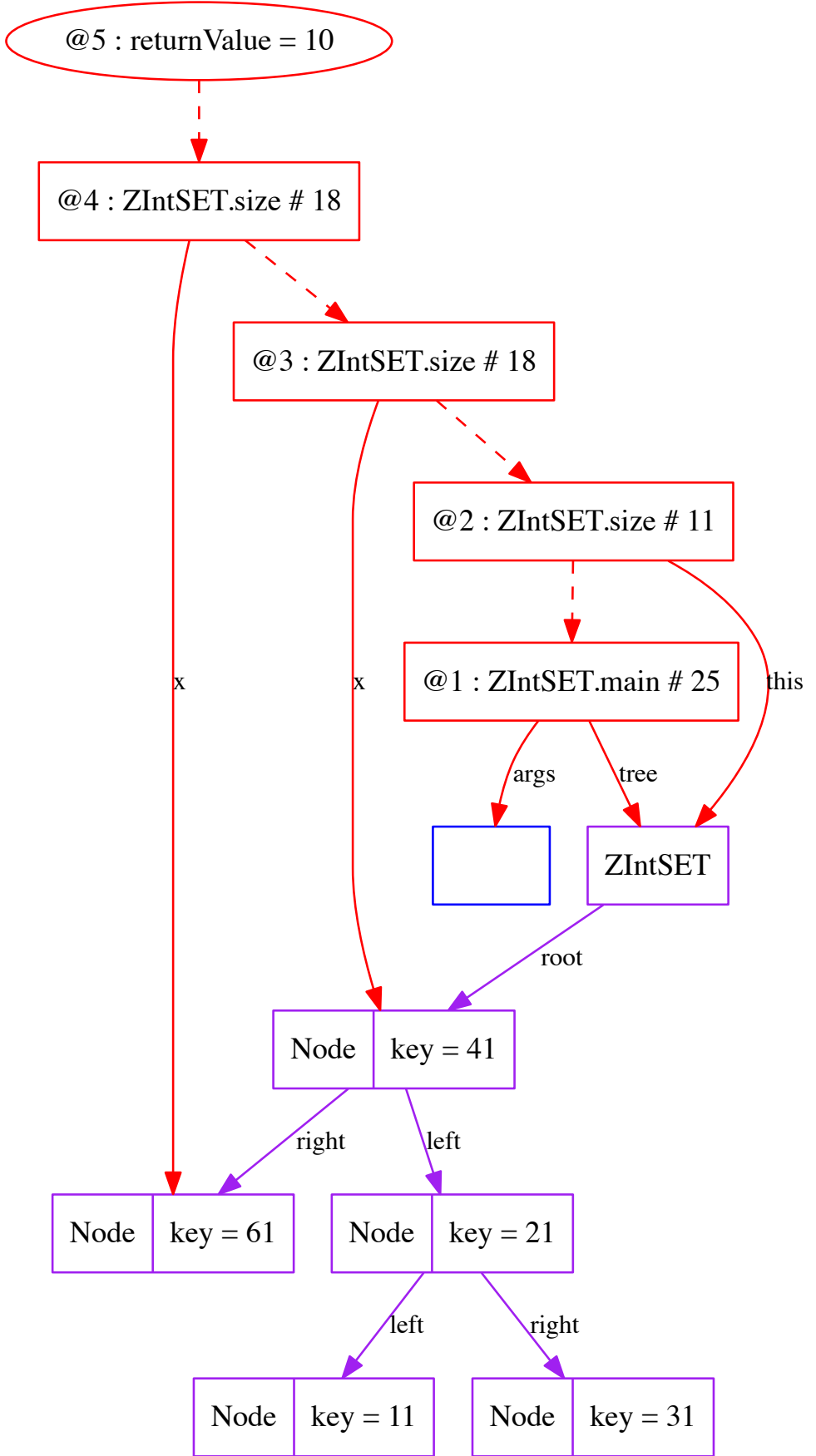

ZIntSET	sz = 10
---------	---------

@4 : ZIntSET.size # 19

@3 : ZIntSET.size # 18

@2 : ZIntSET.size # 11

@1 : ZIntSET.main # 25

--

ZIntSET

Node	key = 41
------	----------

Node	key = 61
------	----------

Node	key = 21
------	----------

Node	key = 11
------	----------

Node	key = 31
------	----------

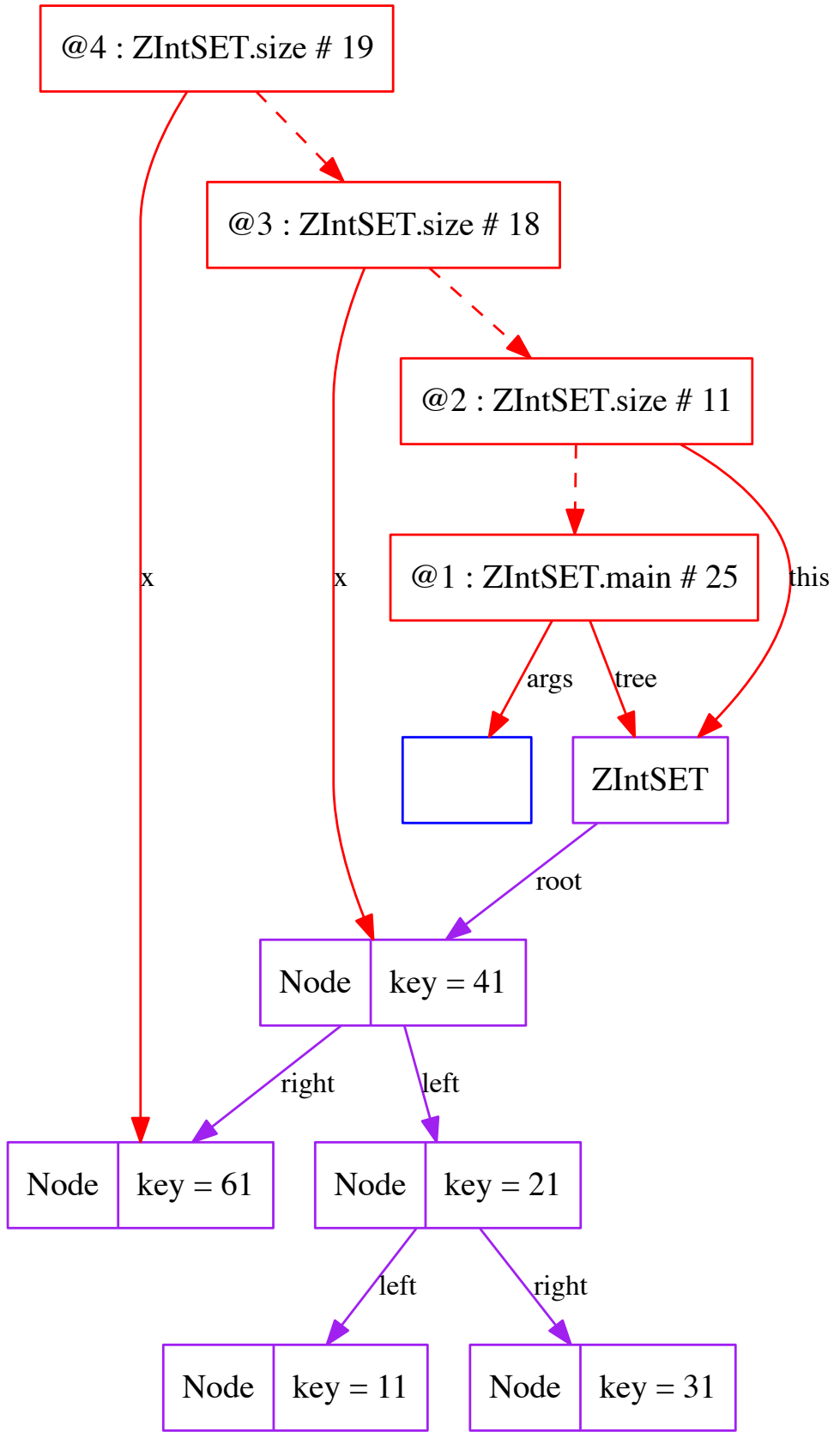

ZIntSET	sz = 10
---------	---------

@4 : return Value = 10

@3 : ZIntSET.size # 18

@2 : ZIntSET.size # 11

@1 : ZIntSET.main # 25

ZIntSET

Node key = 41

Node key = 21

Node key = 61

Node key = 11

Node key = 31

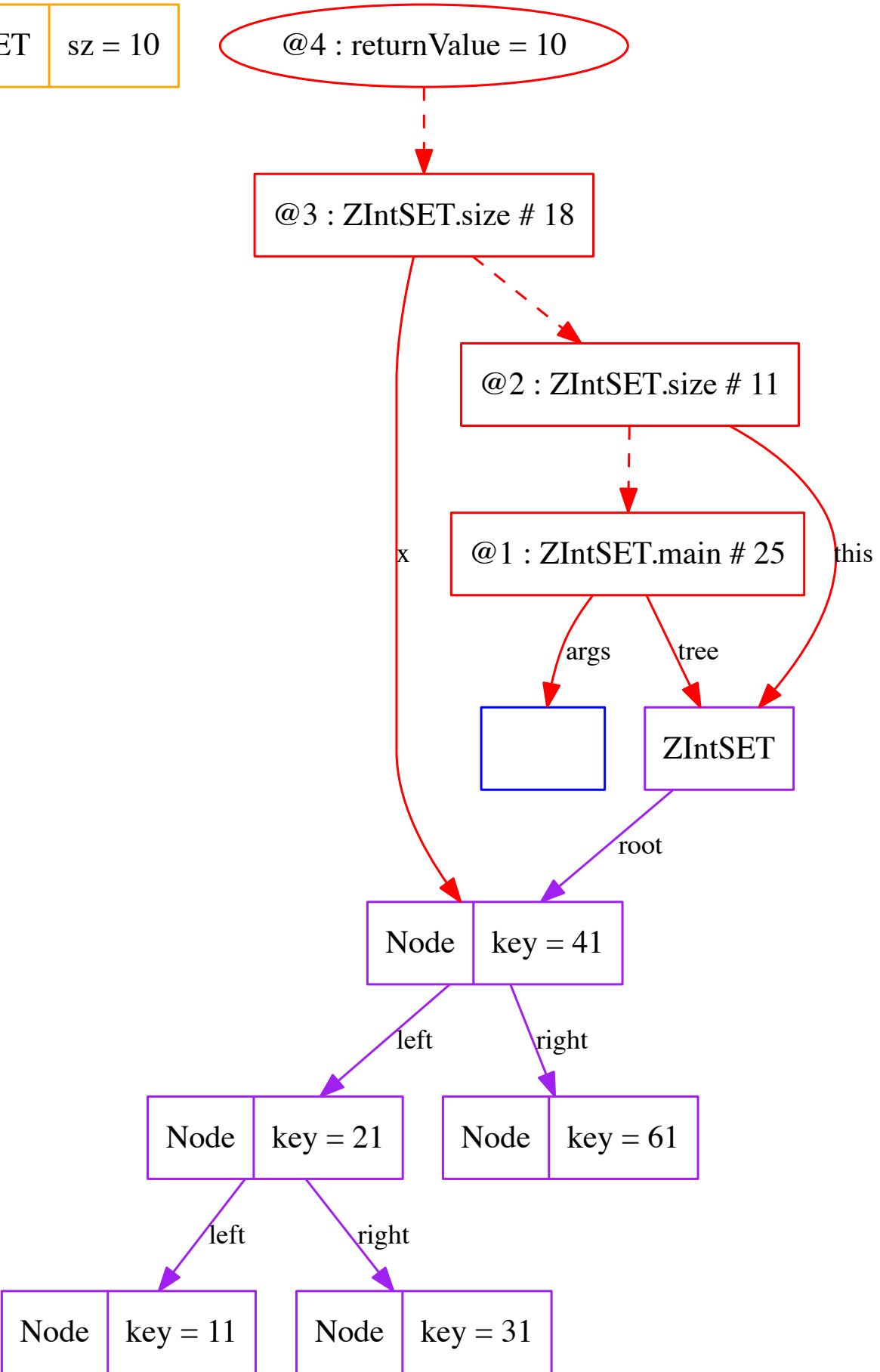

ZIntSET	sz = 10
---------	---------

@3 : ZIntSET.size # 19

@2 : ZIntSET.size # 11

@1 : ZIntSET.main # 25

--

ZIntSET

Node	key = 41
------	----------

Node	key = 21
------	----------

Node	key = 61
------	----------

Node	key = 11
------	----------

Node	key = 31
------	----------

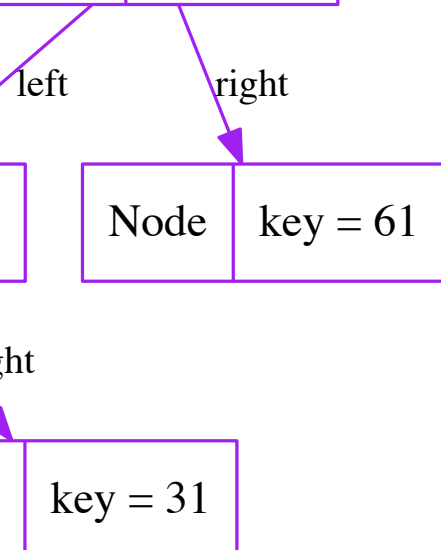
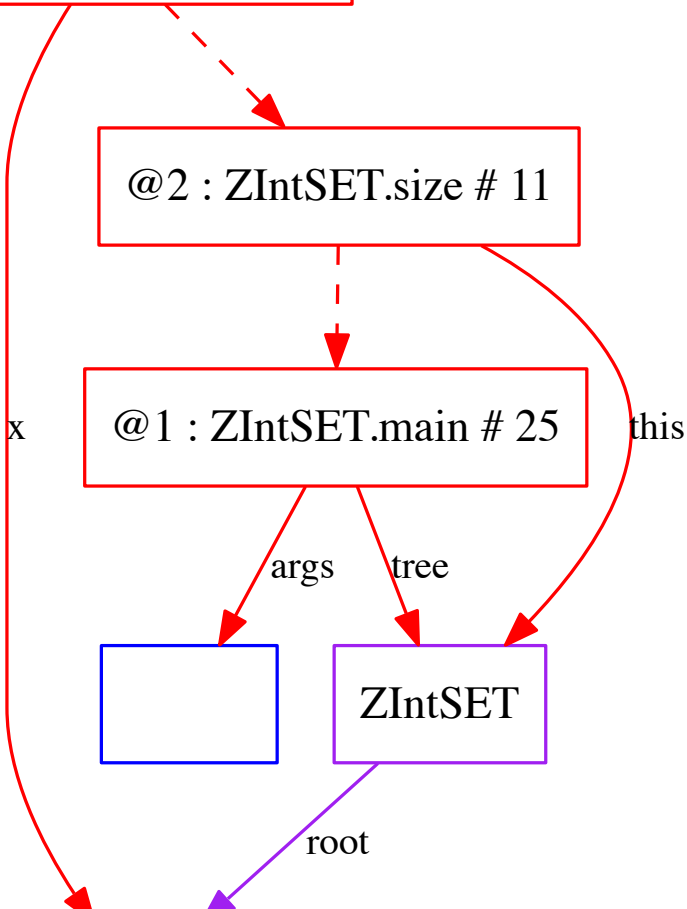

ZIntSET	sz = 10
---------	---------

@3 : returnValue = 10

@2 : ZIntSET.size # 11

@1 : ZIntSET.main # 25

ZIntSET

Node key = 41

Node key = 21

Node key = 61

Node key = 11

Node key = 31

ZIntSET	sz = 10
---------	---------

@3 : returnValue = 10

@2 : ZIntSET.size # 12

@1 : ZIntSET.main # 25

ZIntSET

Node key = 41

Node key = 21

Node key = 61

Node key = 11

Node key = 31