

```

2 public class ZIntSET {
3     private Node root;
4     private static class Node {
5         public final int key;
6         public Node left, right;
7         public Node(int key) { this.key = key; }
8     }
9
10    public int size () {
11        return size (root);
12    }
13    private int sz = 0;
14    private int size (Node x) {
15        if (x == null) return sz;
16        sz = sz + 1;
17        size (x.left);
18        size (x.right);
19        return sz;
20    }
21
22    public static void main (String[] args) {
23        ZIntSET tree = ZIntSET.fromString ("41 21 61 11 31");
24        tree.size ();
25        tree.size ();
26    }

```

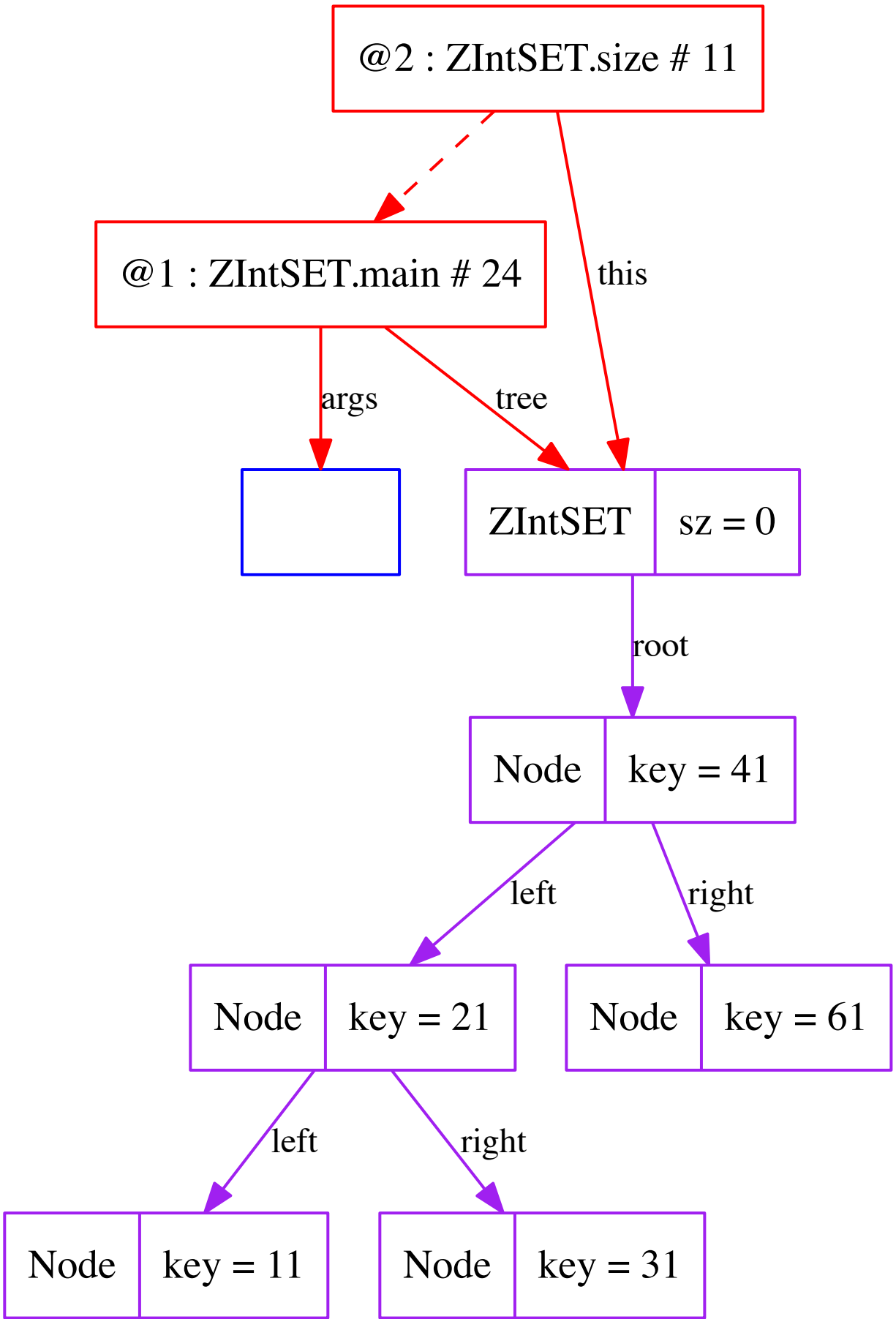

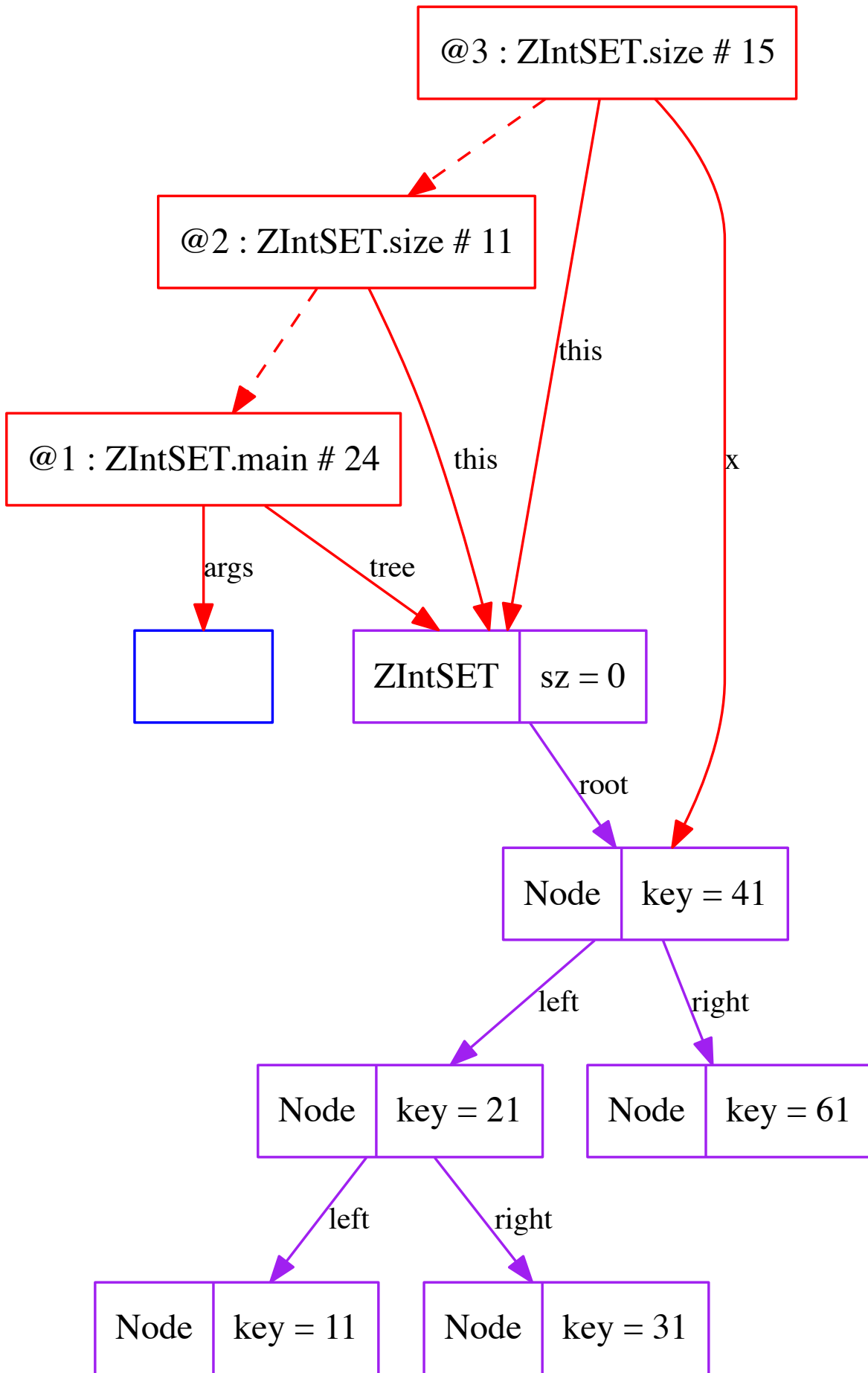

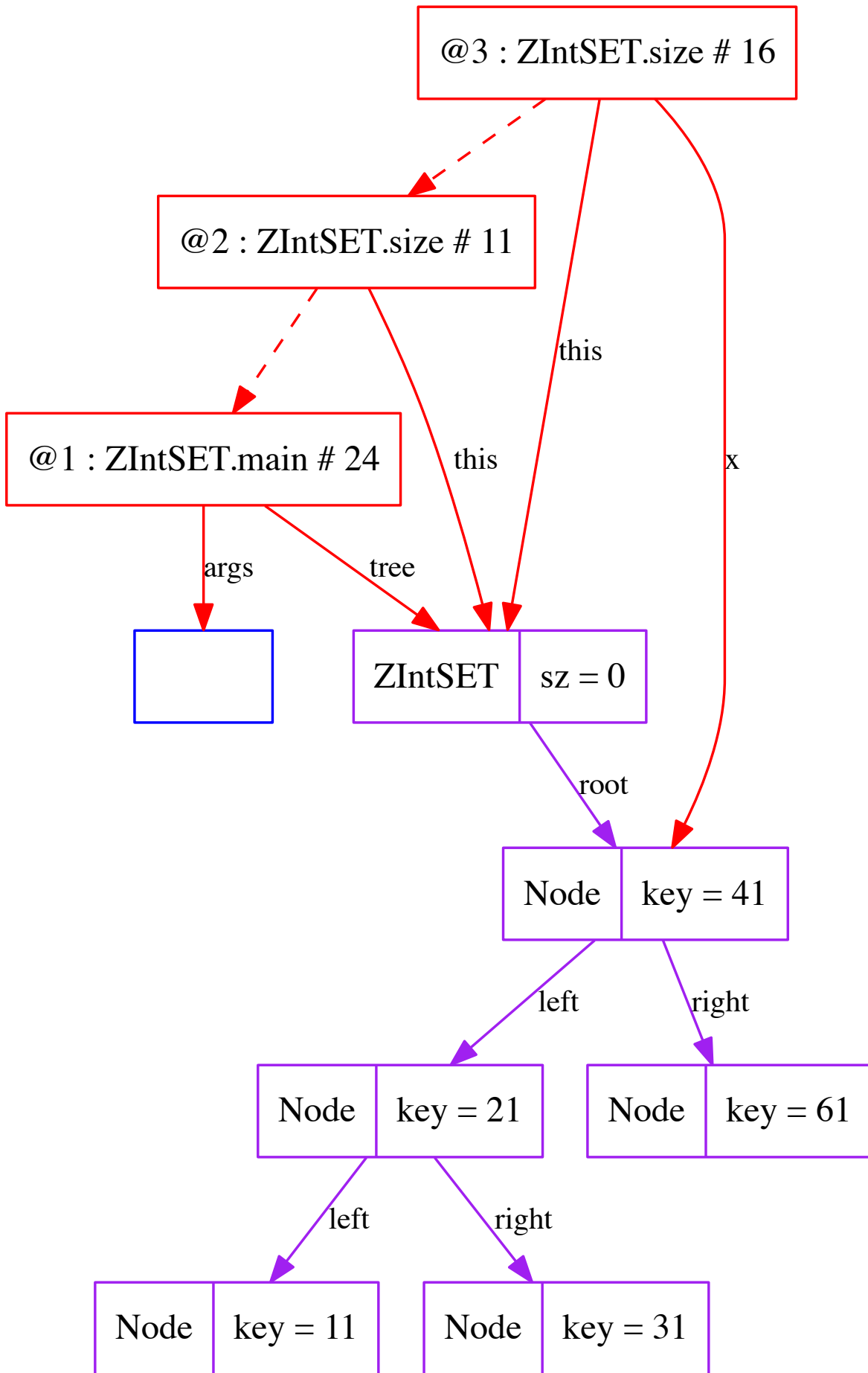

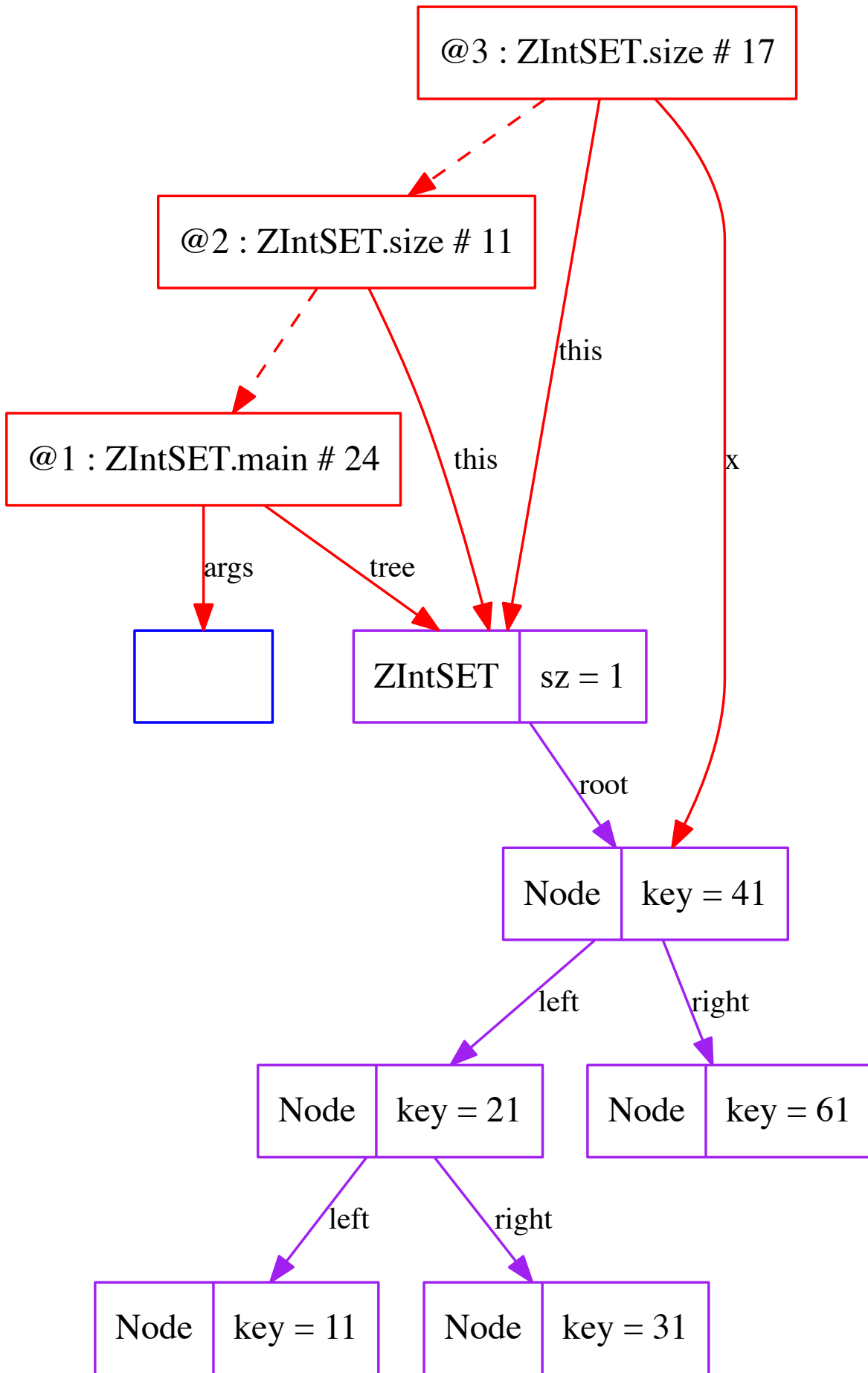

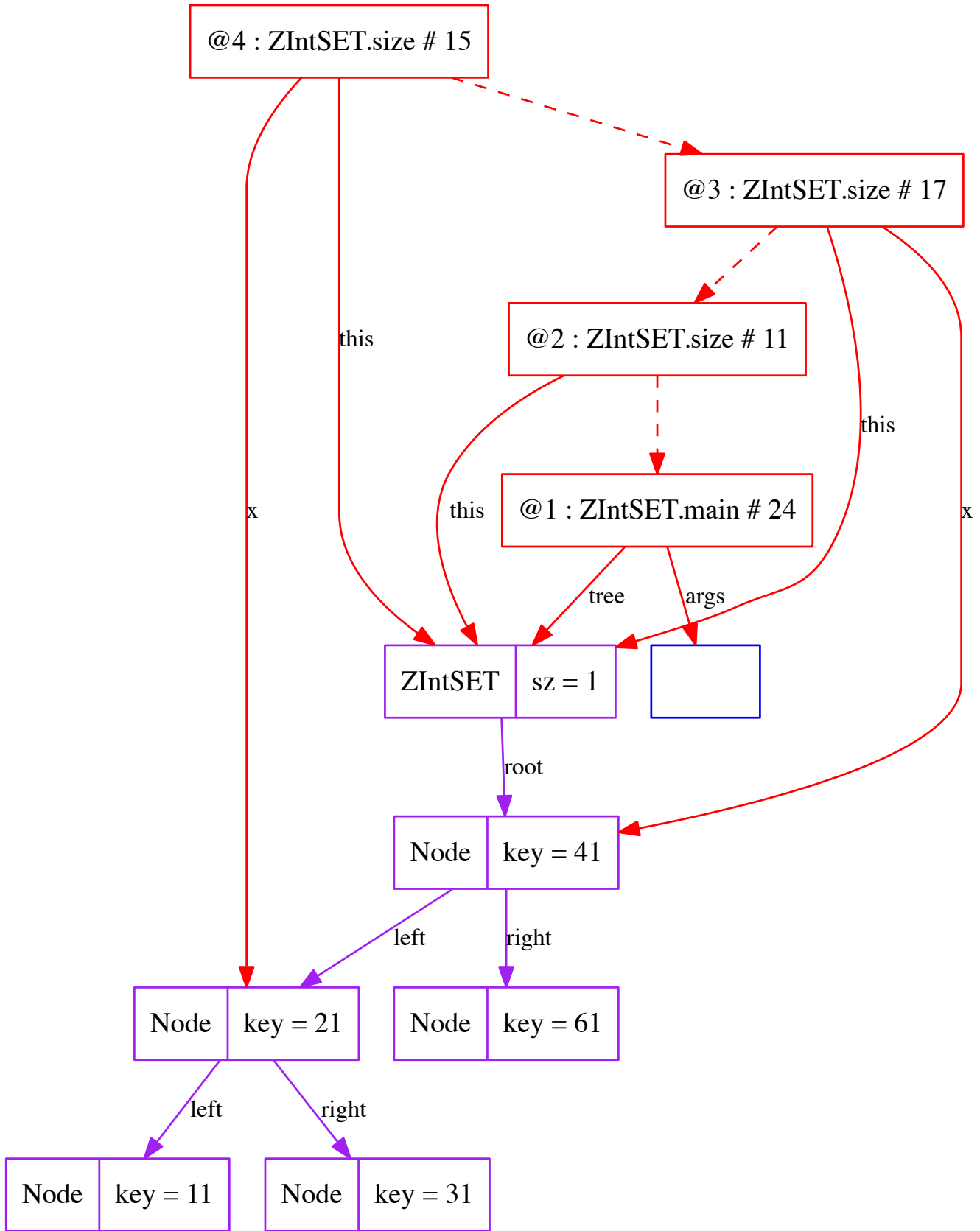

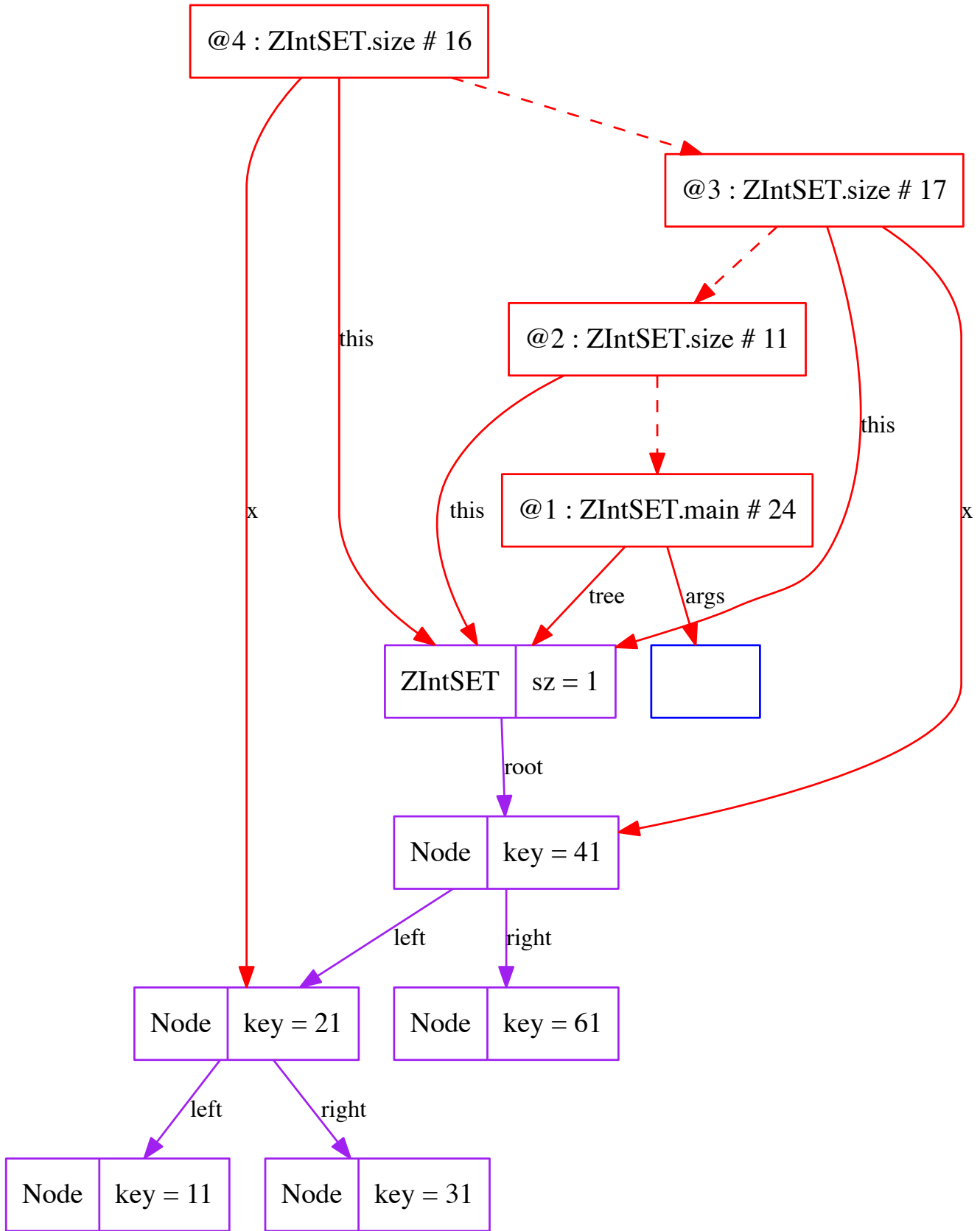

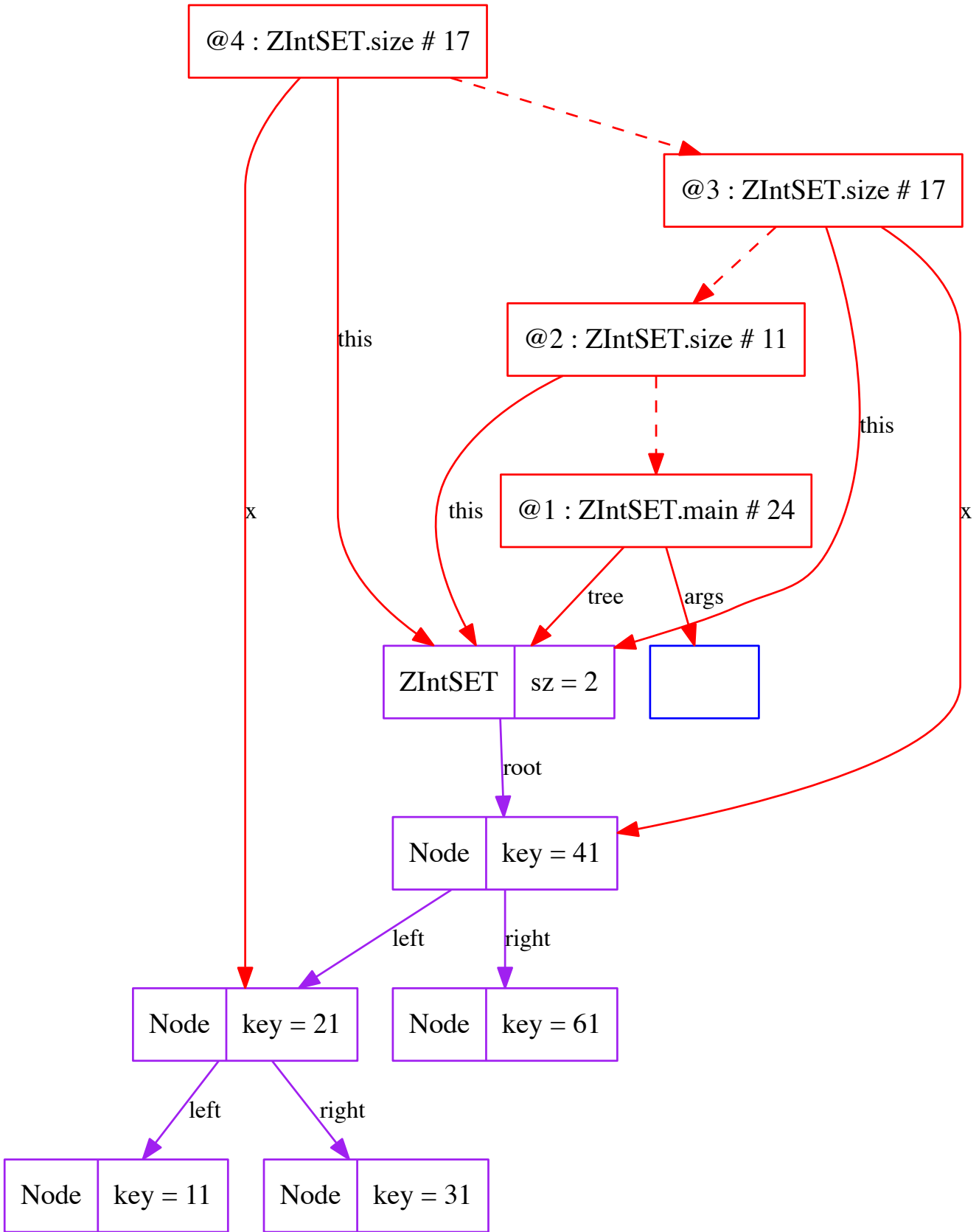

@5 : ZIntSET.size # 15

@4 : ZIntSET.size # 17

@3 : ZIntSET.size # 17

@2 : ZIntSET.size # 11

@1 : ZIntSET.main # 24

[]

ZIntSET sz = 2

Node key = 41

Node key = 61

Node key = 21

Node key = 11

Node key = 31

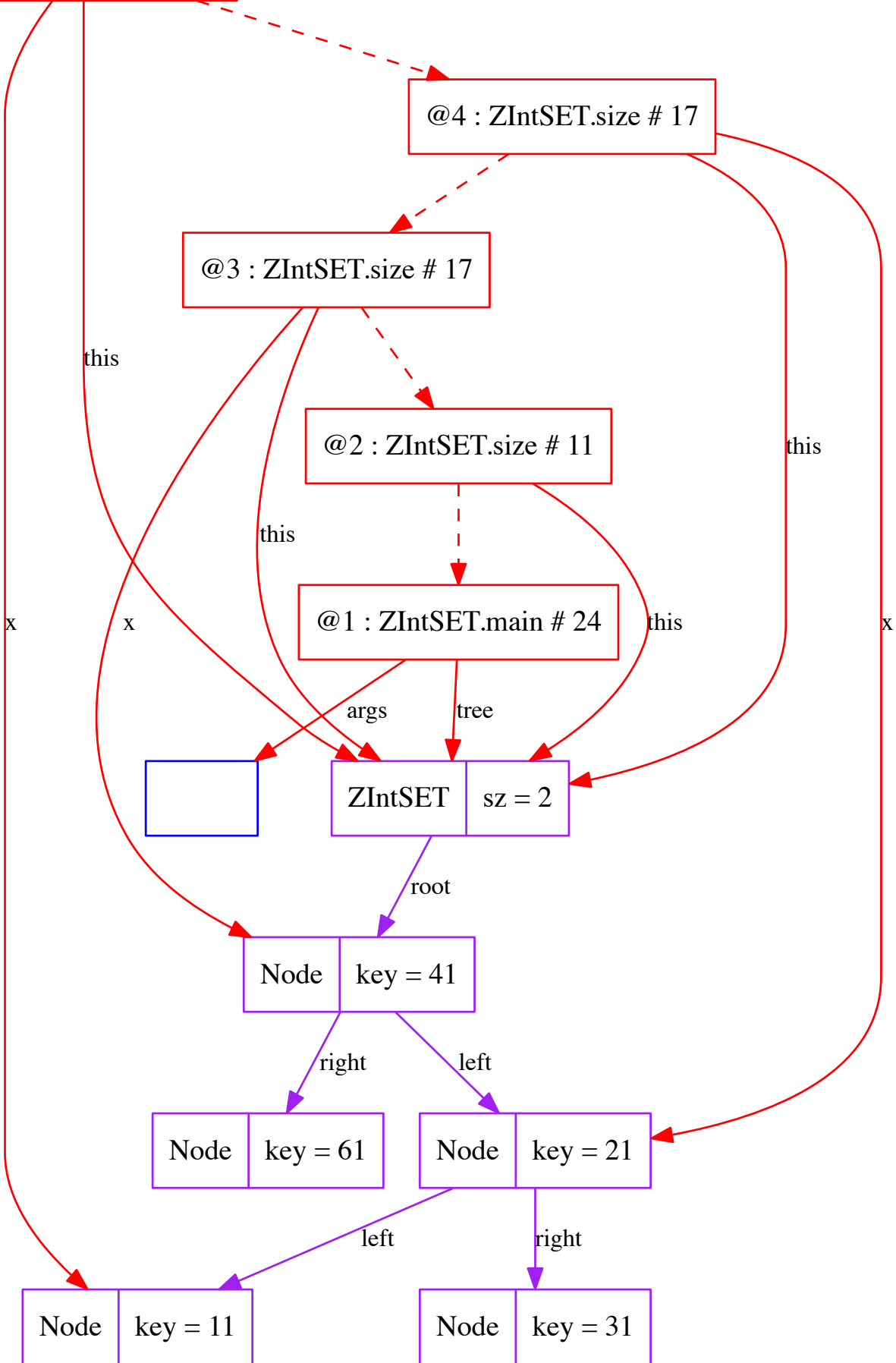

@5 : ZIntSET.size # 16

@4 : ZIntSET.size # 17

@3 : ZIntSET.size # 17

@2 : ZIntSET.size # 11

@1 : ZIntSET.main # 24

[]

ZIntSET sz = 2

Node key = 41

Node key = 61

Node key = 21

Node key = 11

Node key = 31

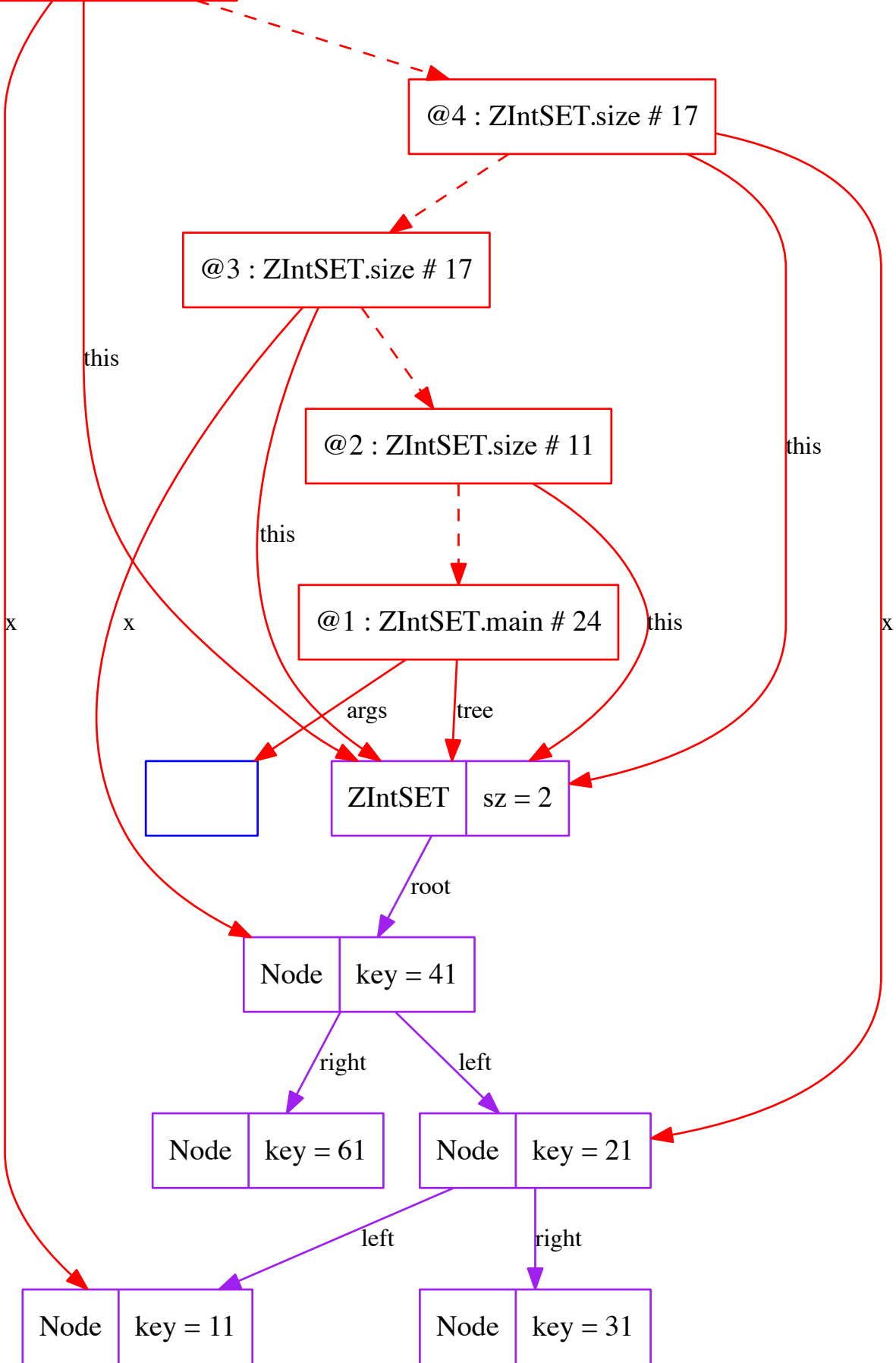

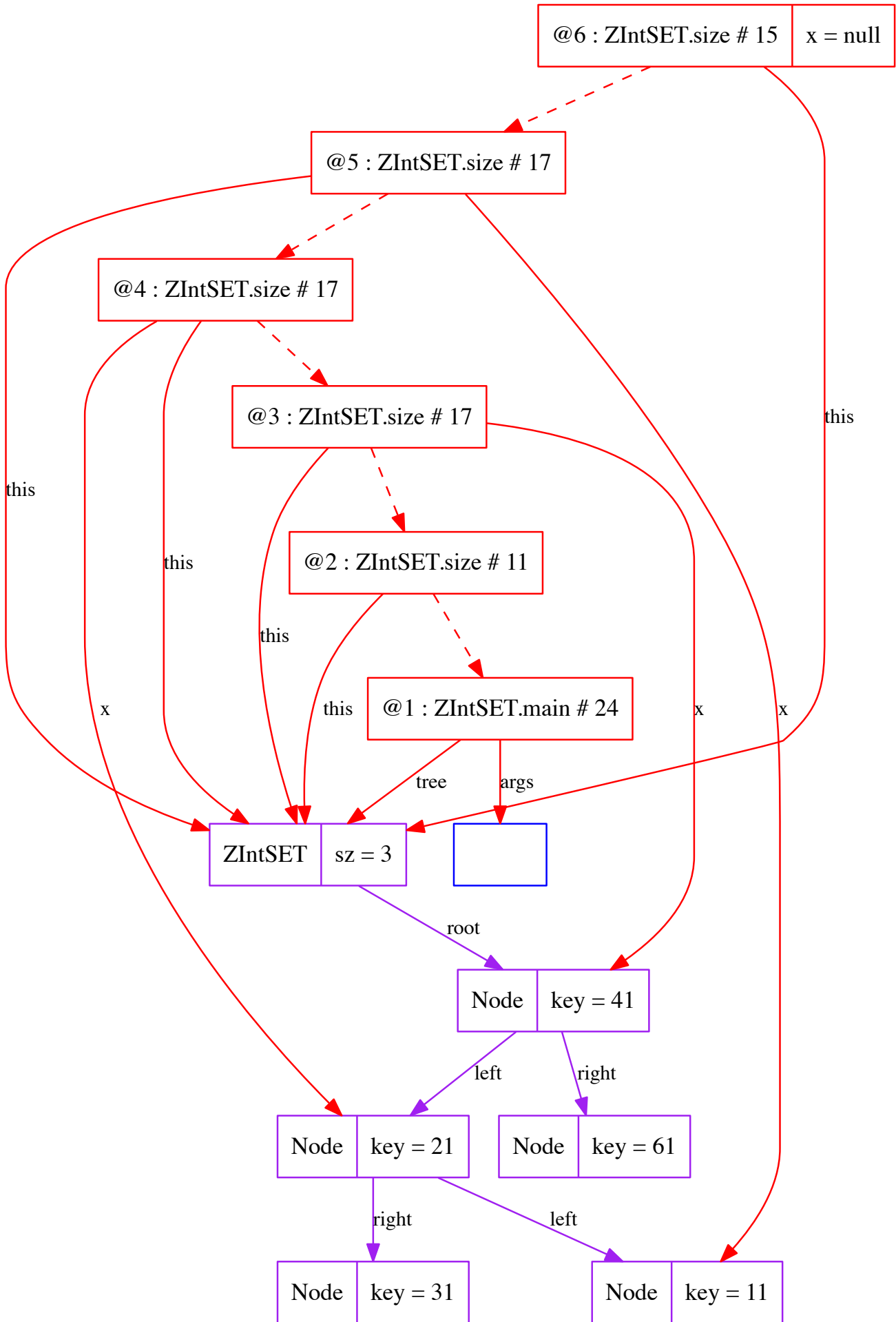

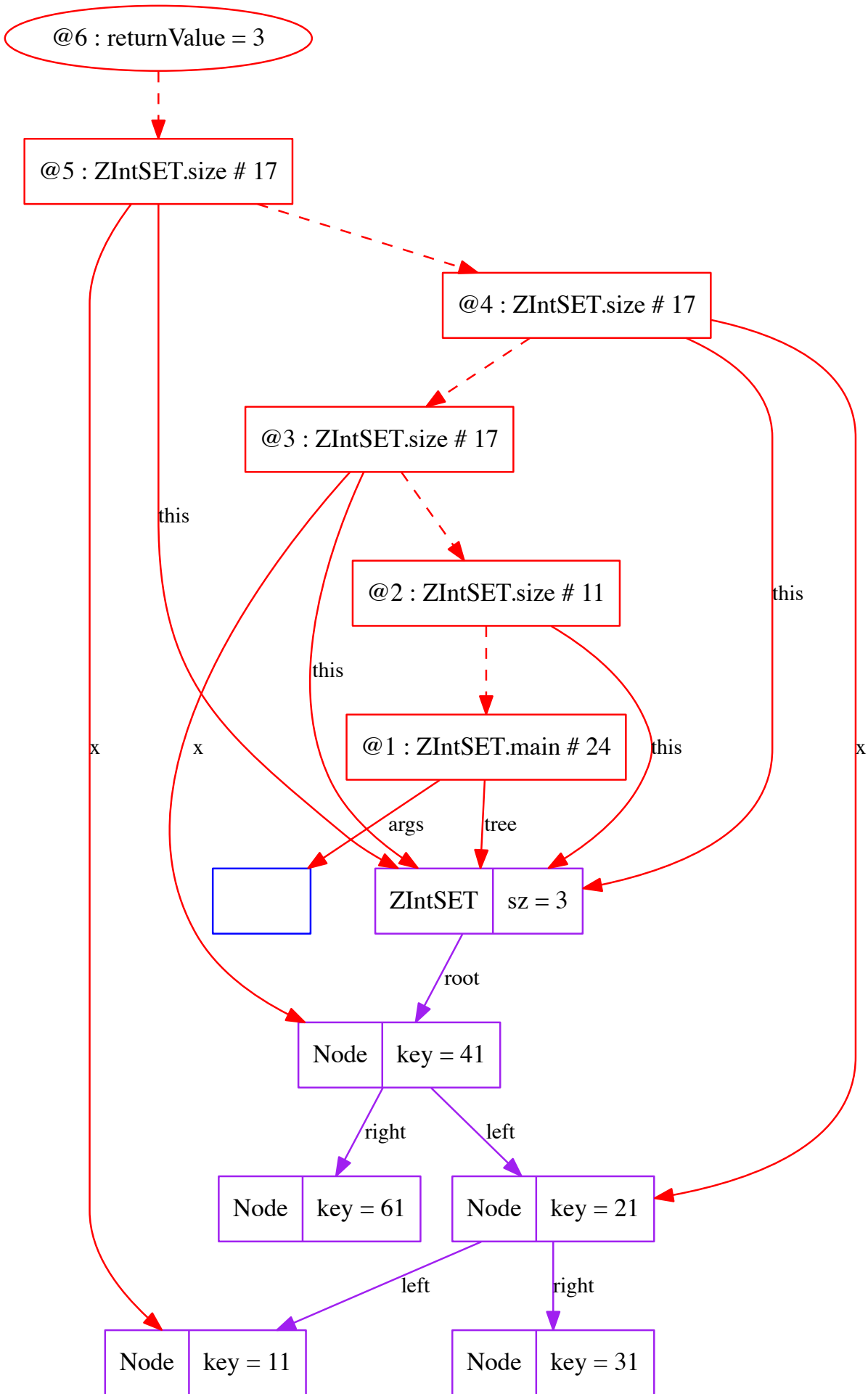

@5 : ZIntSET.size # 18

@4 : ZIntSET.size # 17

@3 : ZIntSET.size # 17

@2 : ZIntSET.size # 11

@1 : ZIntSET.main # 24

ZIntSET sz = 3

Node key = 41

Node key = 61

Node key = 21

Node key = 11

Node key = 31

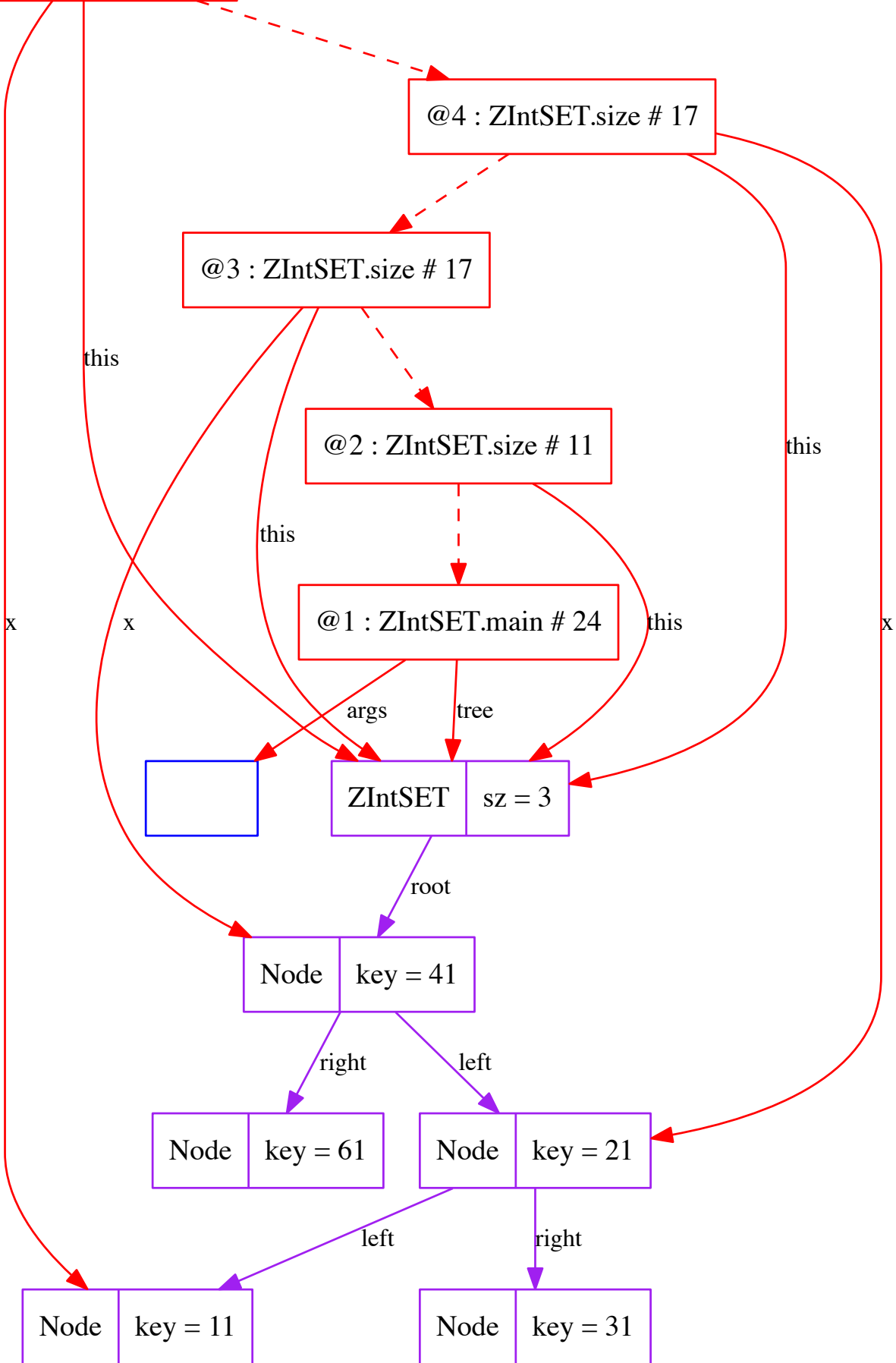

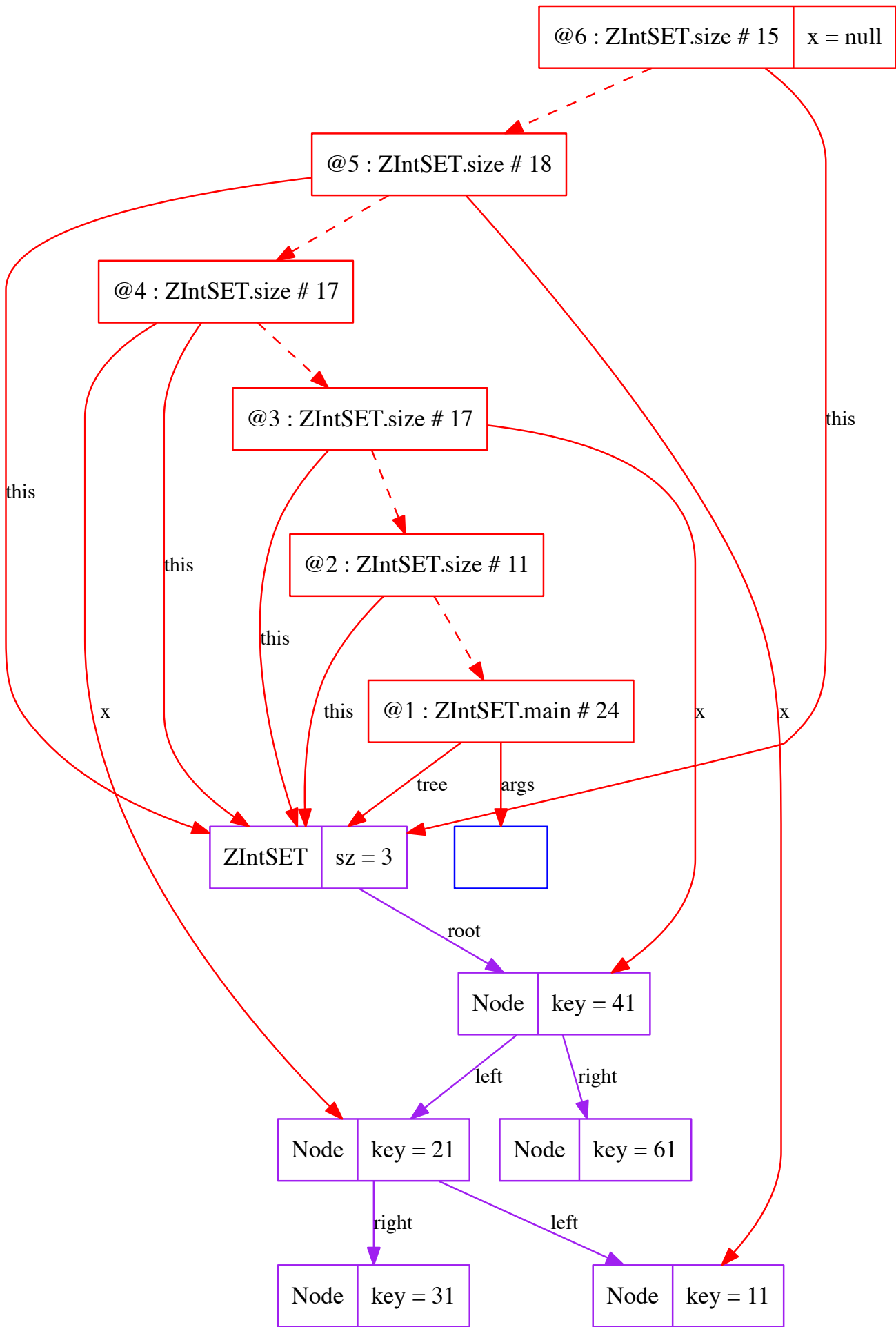

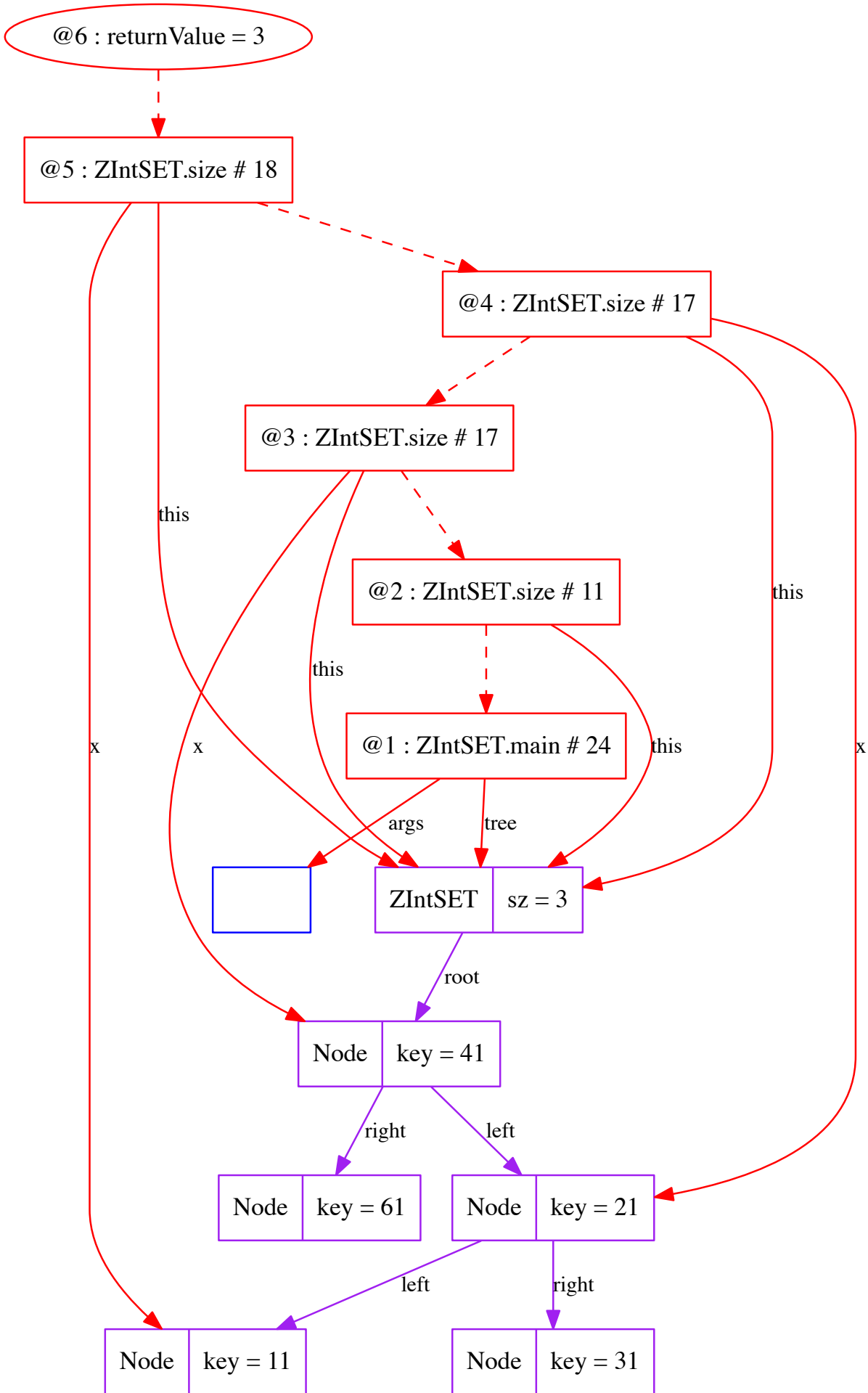

@5 : ZIntSET.size # 19

@4 : ZIntSET.size # 17

@3 : ZIntSET.size # 17

@2 : ZIntSET.size # 11

@1 : ZIntSET.main # 24

[]

ZIntSET sz = 3

Node key = 41

Node key = 61

Node key = 21

Node key = 11

Node key = 31

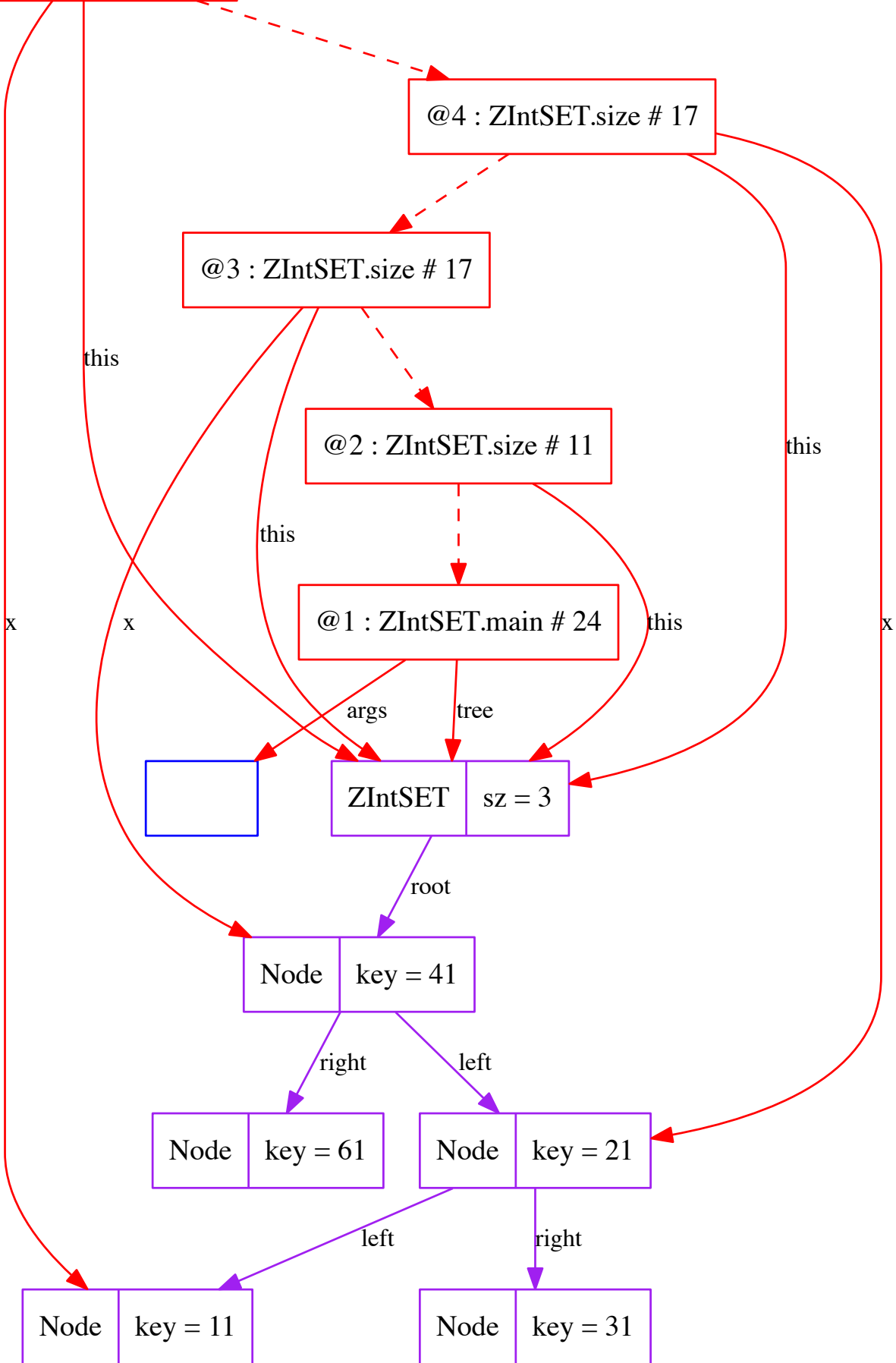

@5 : returnValue = 3

@4 : ZIntSET.size # 17

@3 : ZIntSET.size # 17

@2 : ZIntSET.size # 11

@1 : ZIntSET.main # 24

ZIntSET sz = 3

Node key = 41

Node key = 21

Node key = 61

Node key = 11

Node key = 31

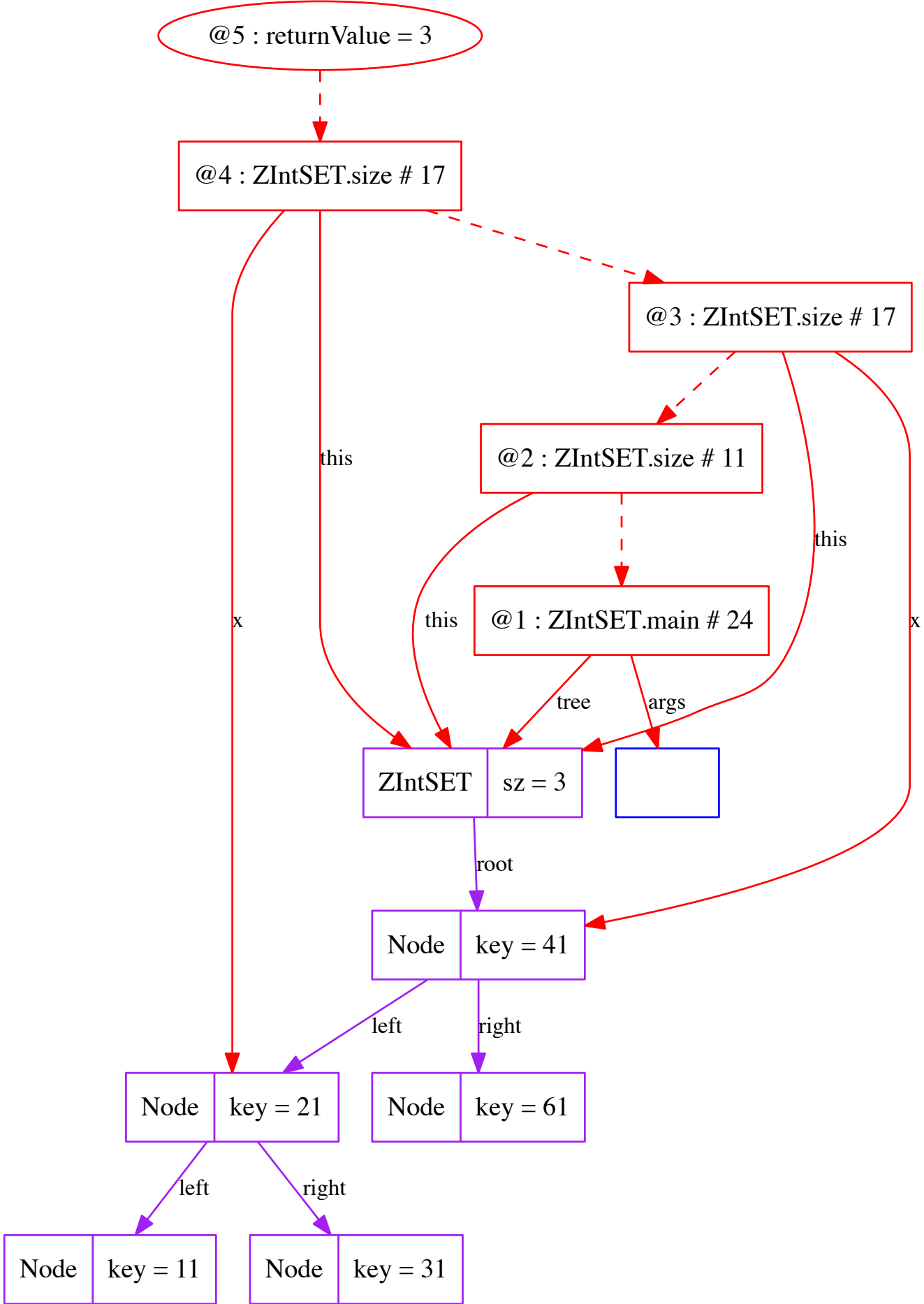

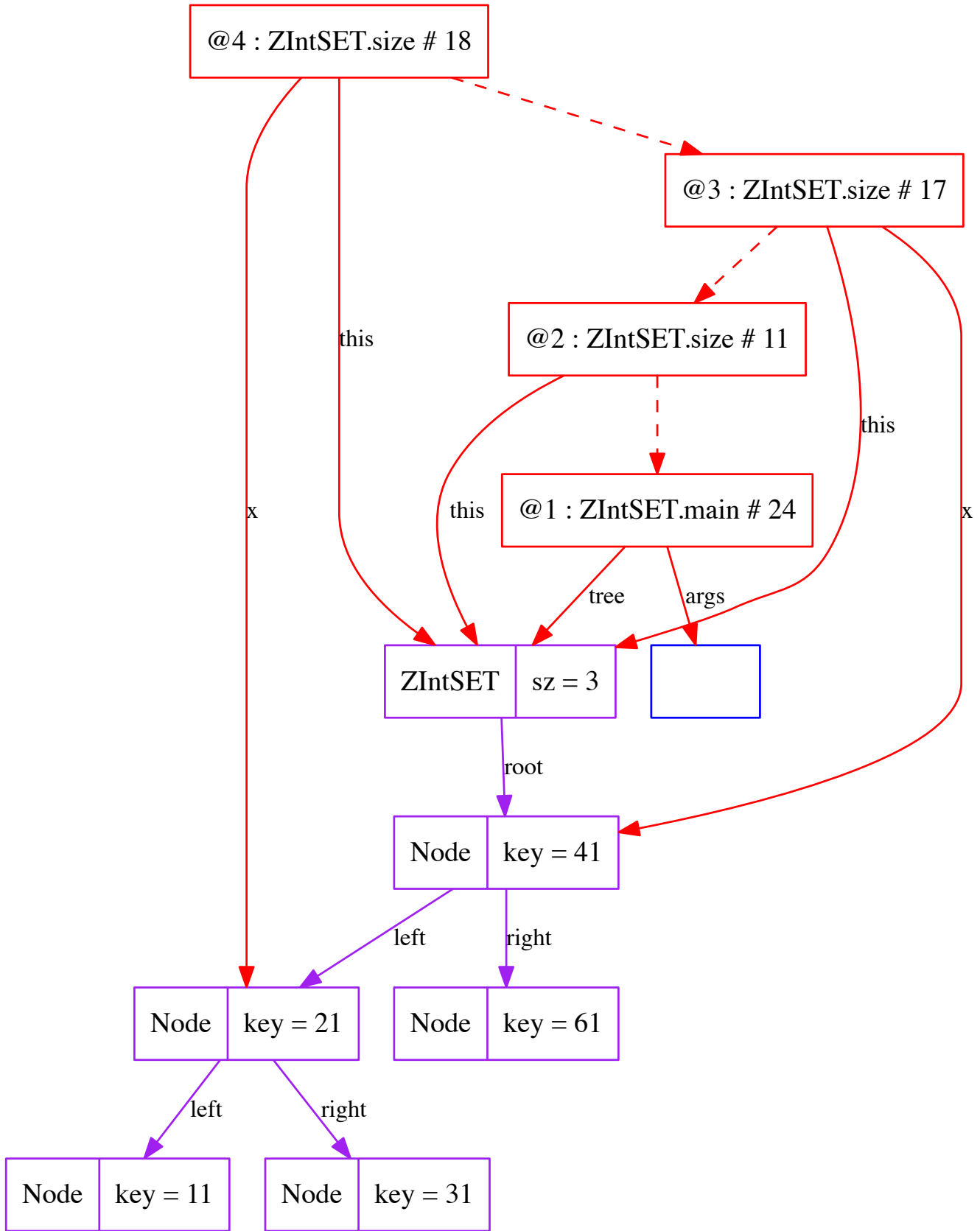

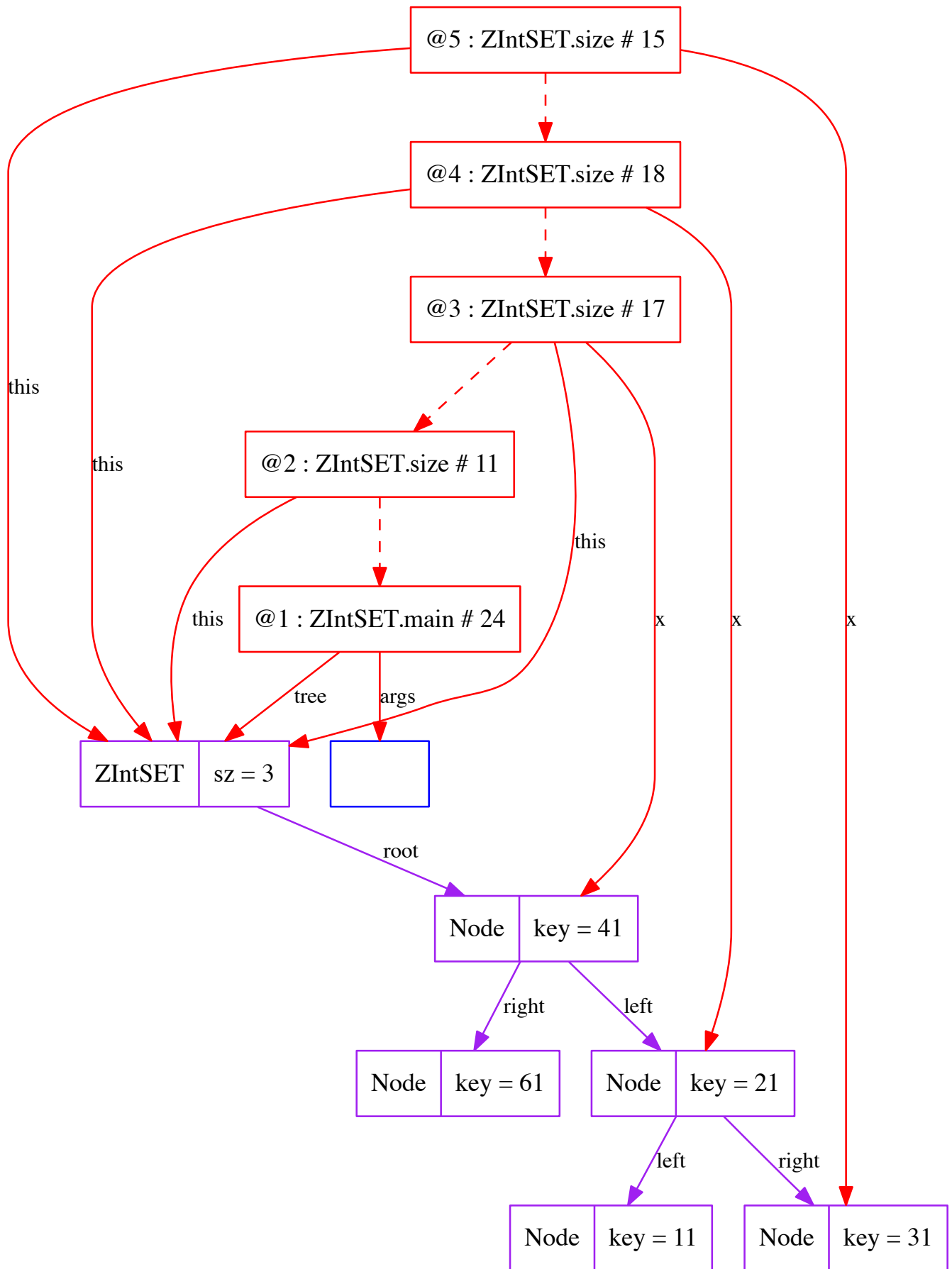

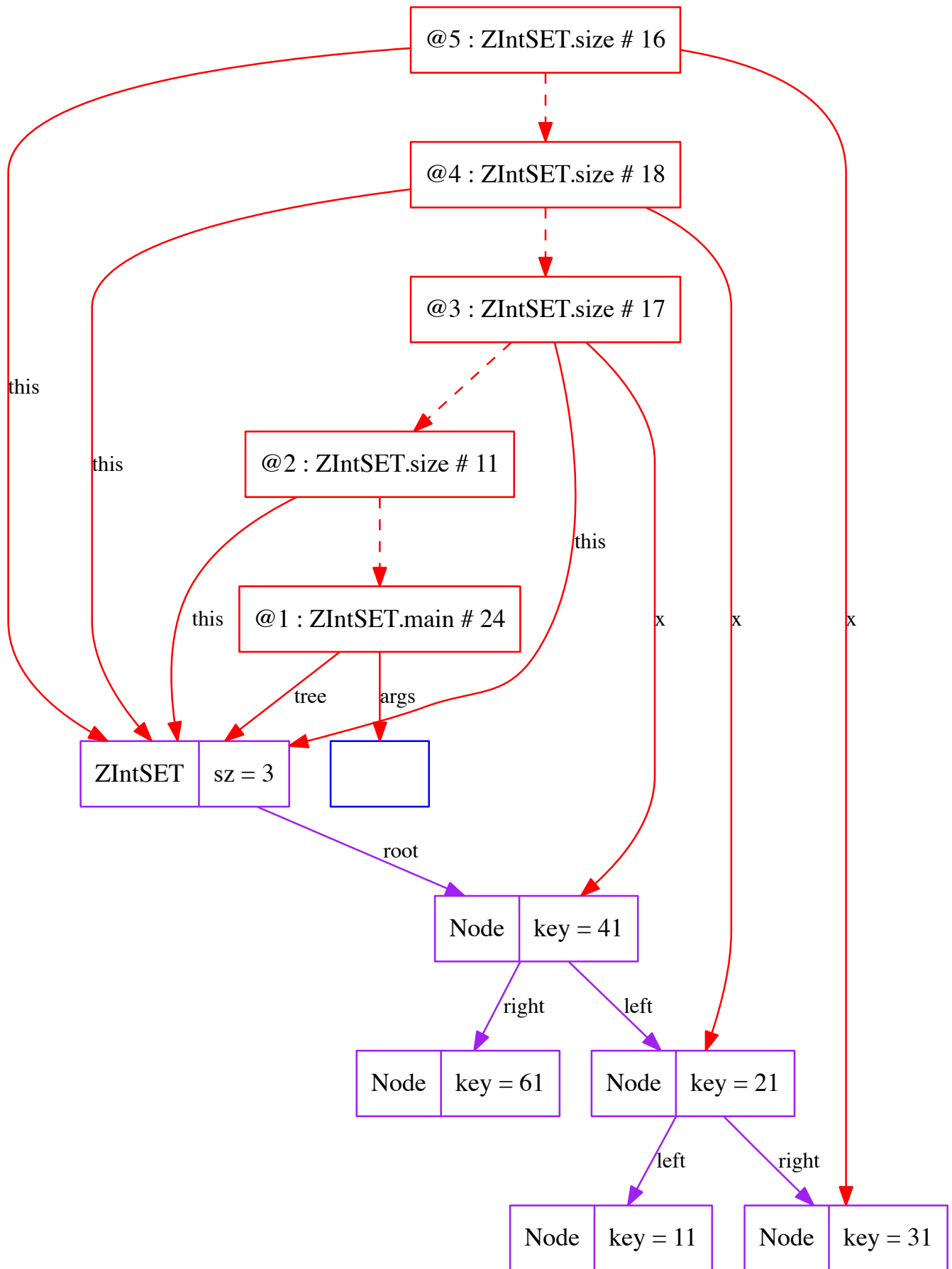

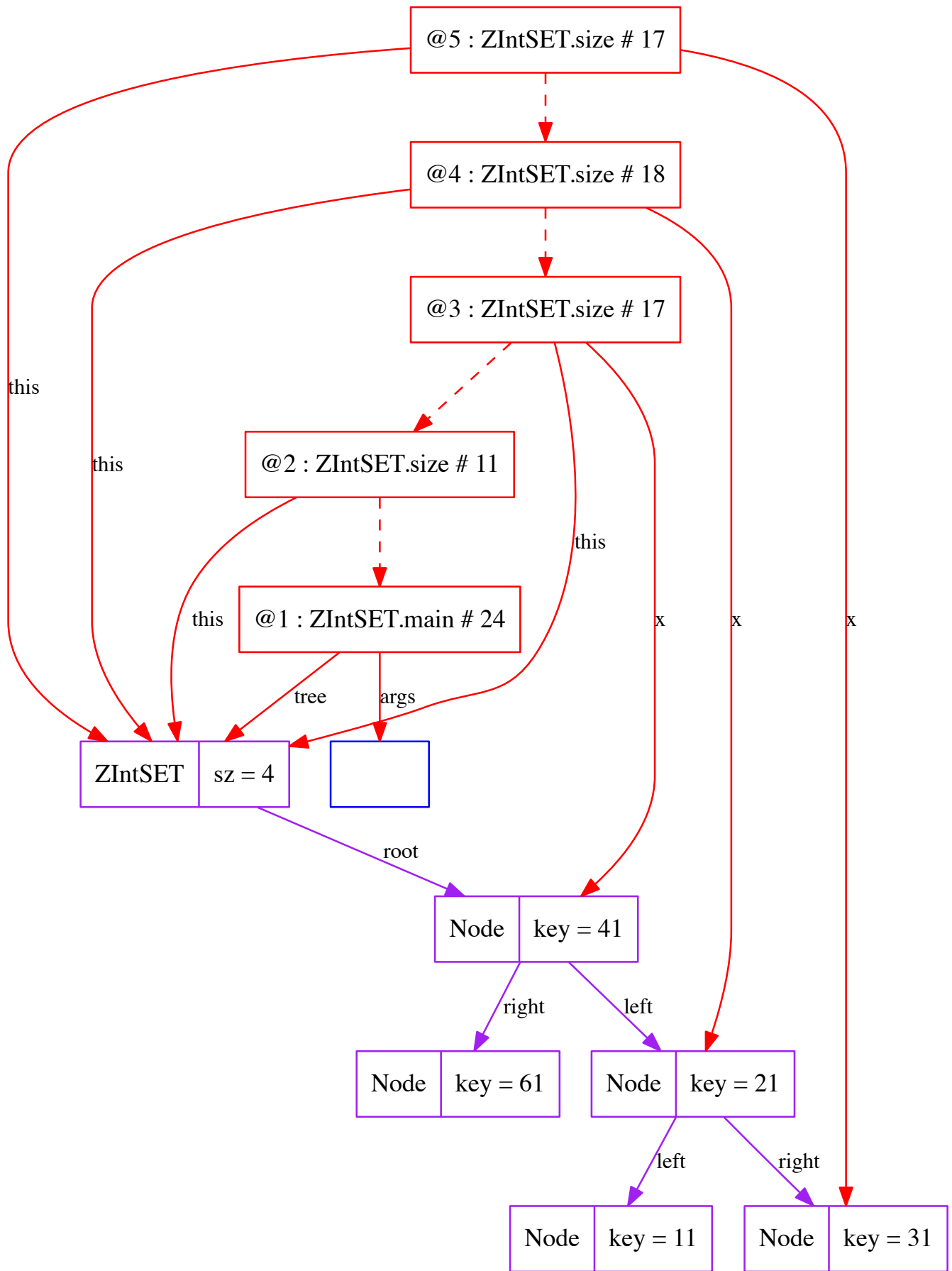

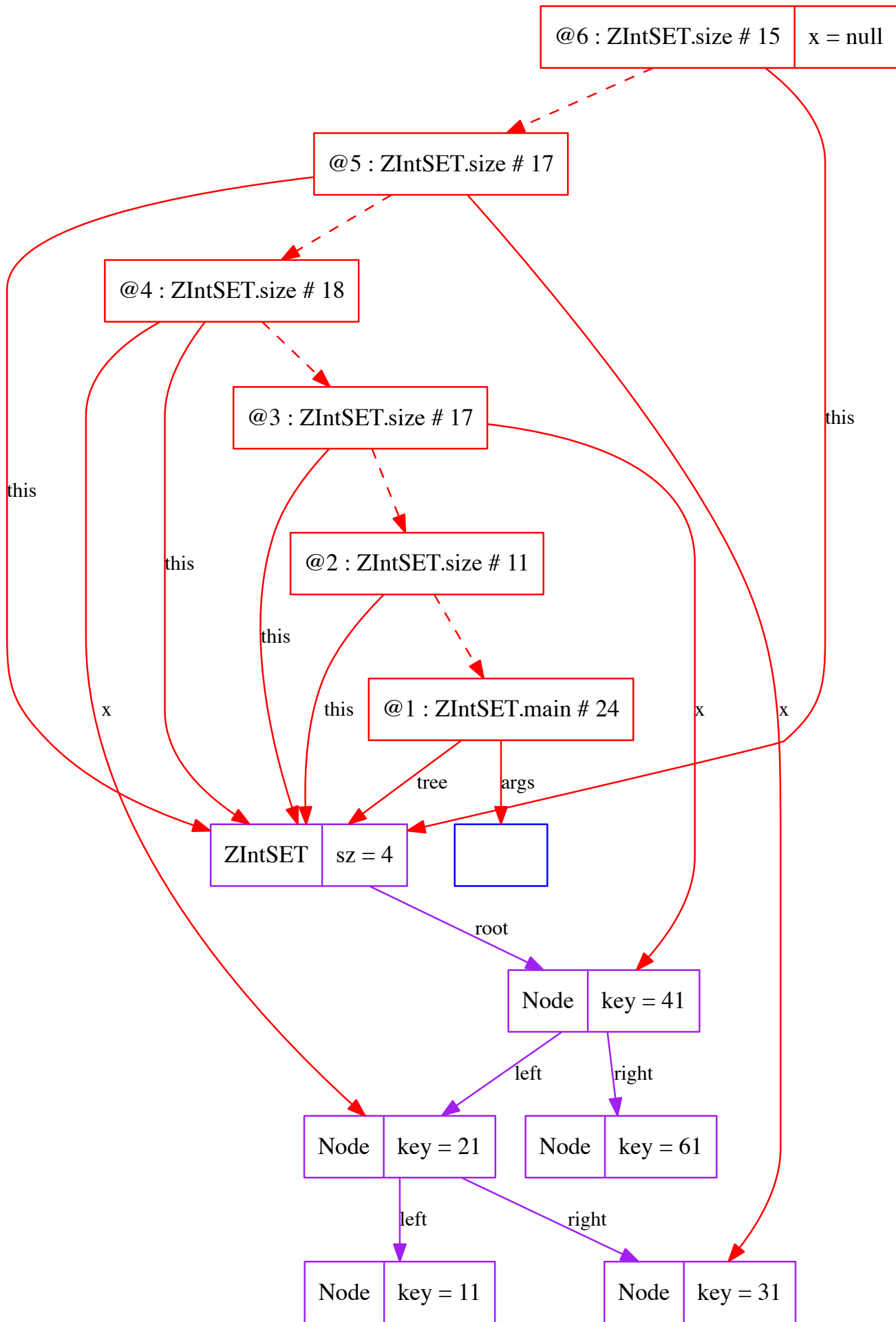

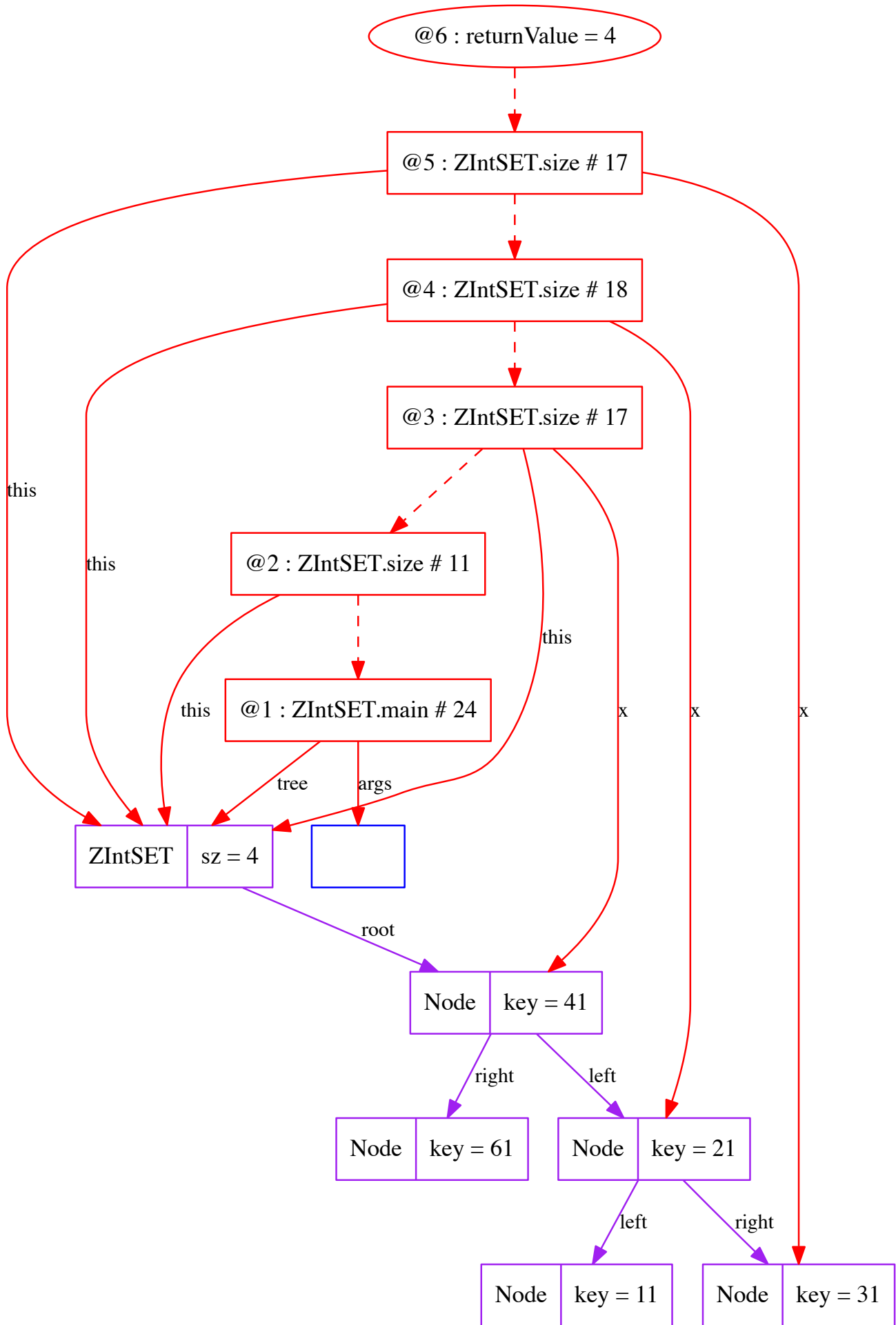

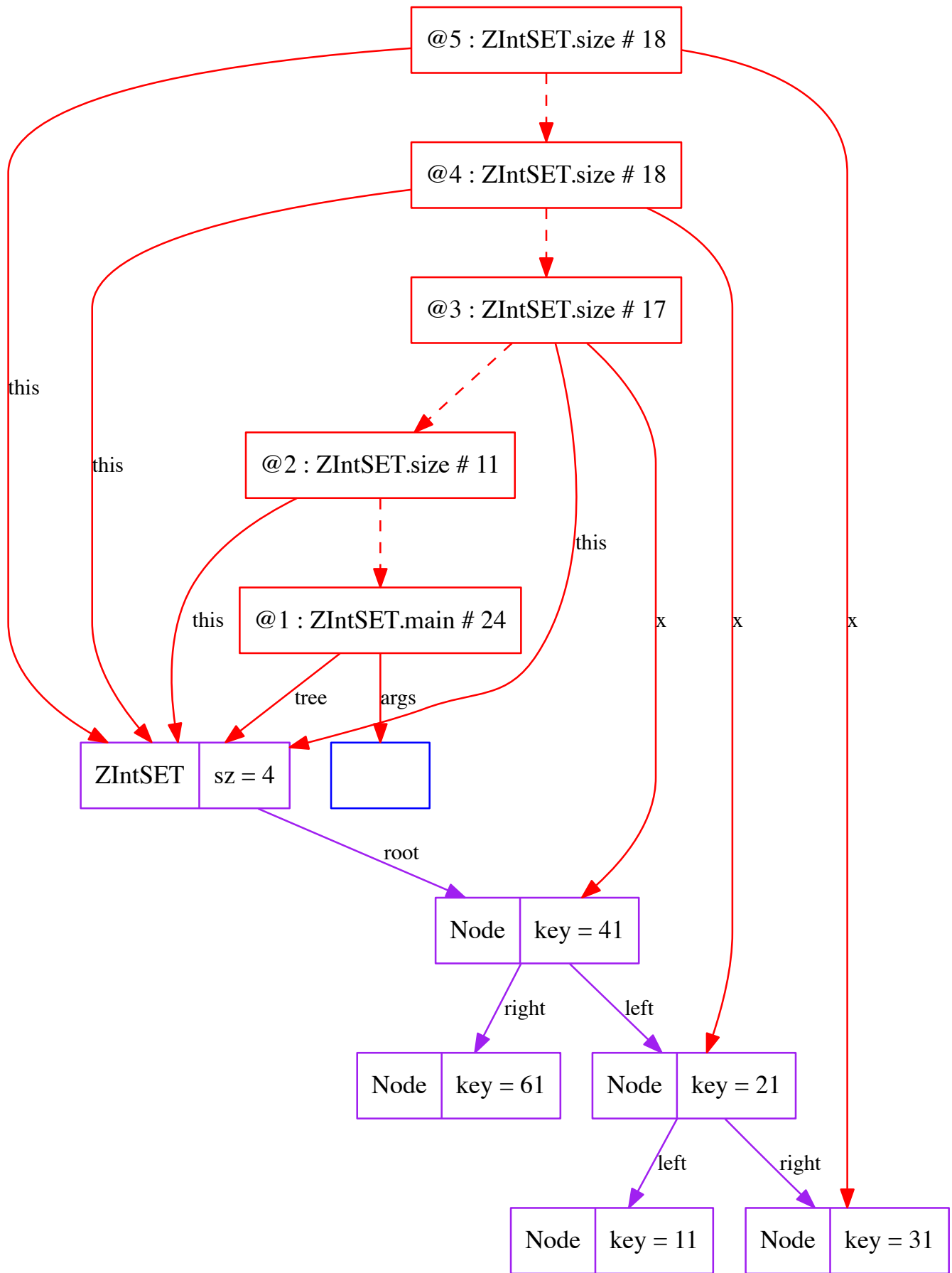

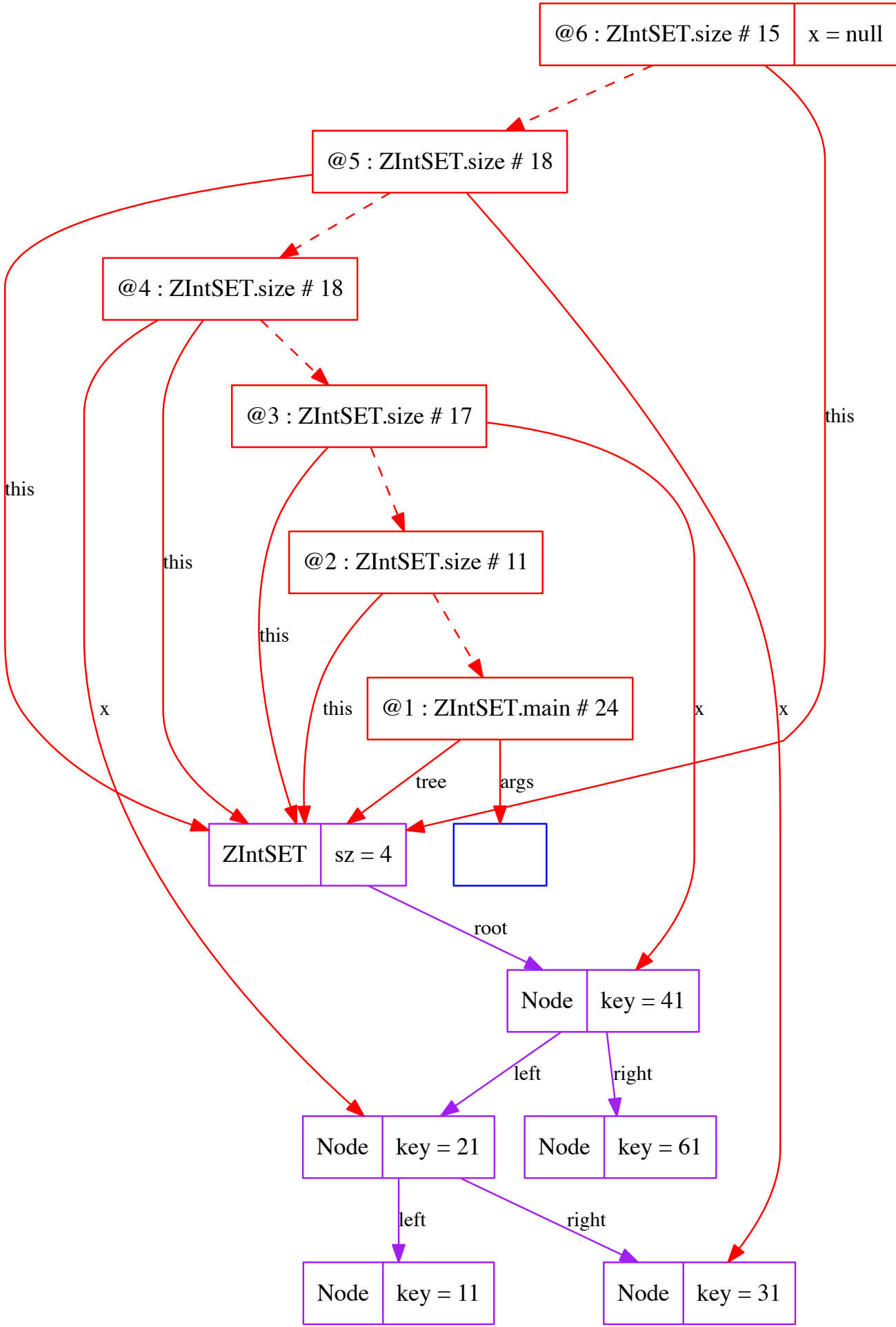

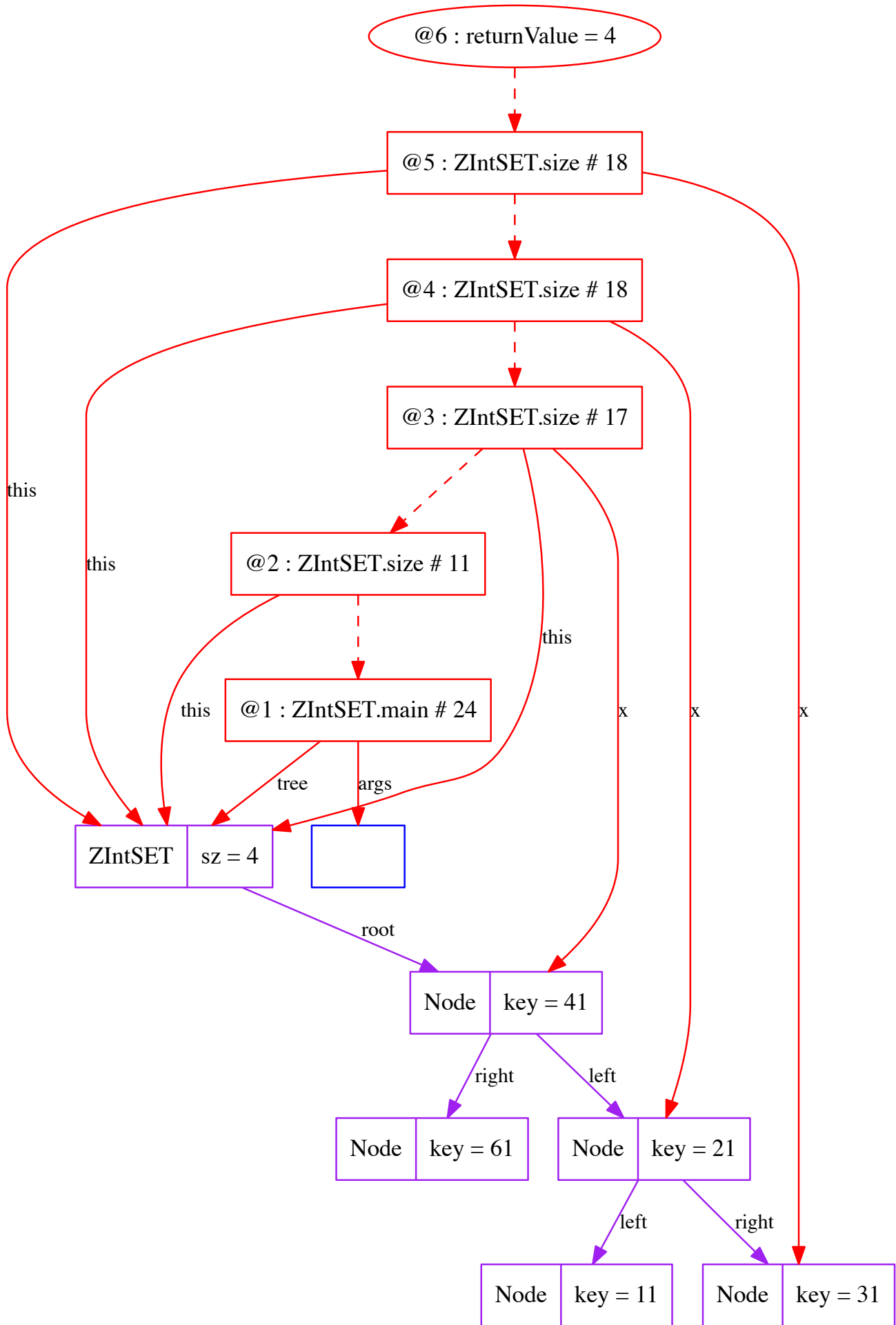

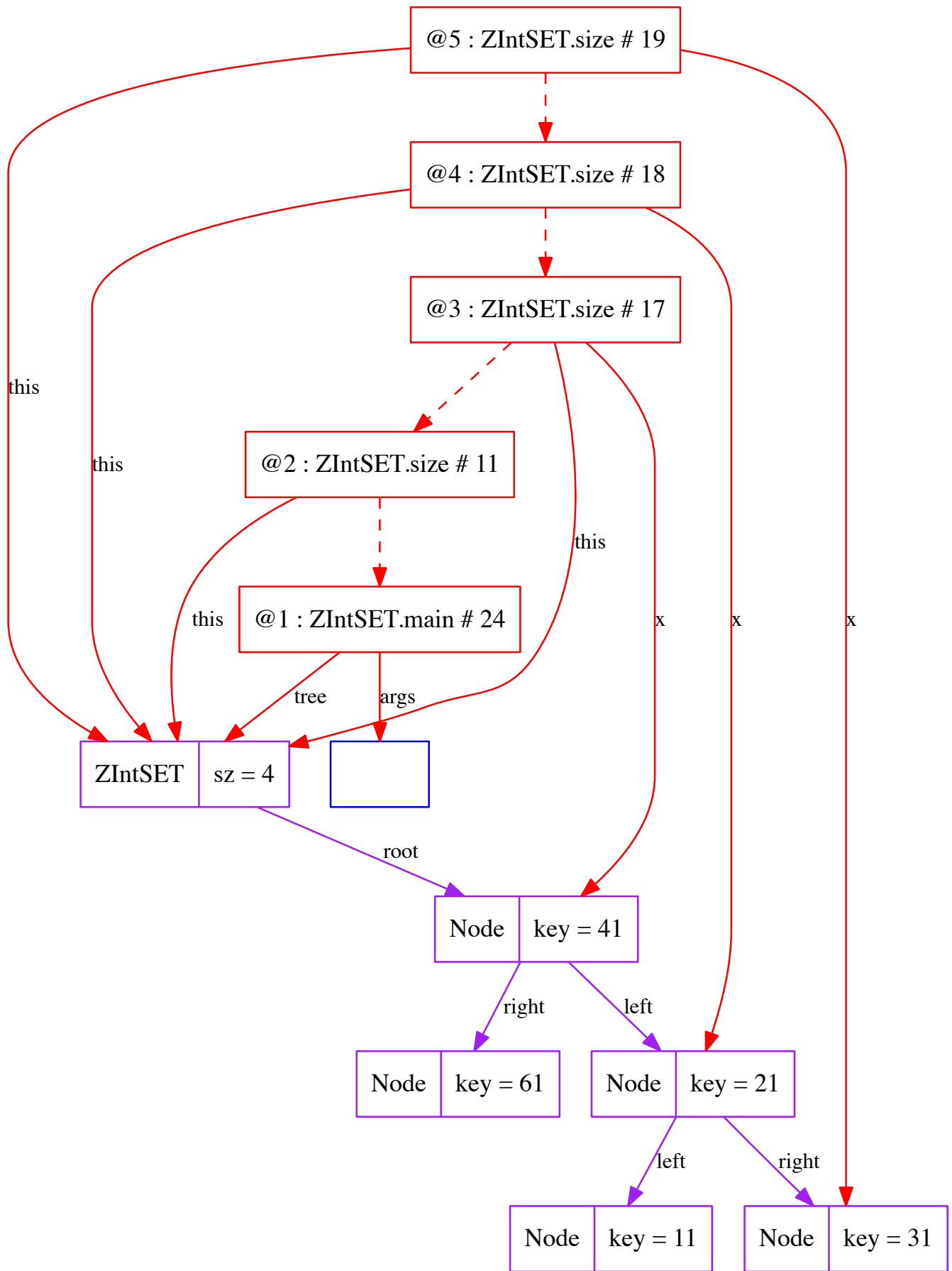

@5 : returnValue = 4

@4 : ZIntSET.size # 18

@3 : ZIntSET.size # 17

@2 : ZIntSET.size # 11

@1 : ZIntSET.main # 24

ZIntSET sz = 4

Node key = 41

Node key = 21

Node key = 61

Node key = 11

Node key = 31

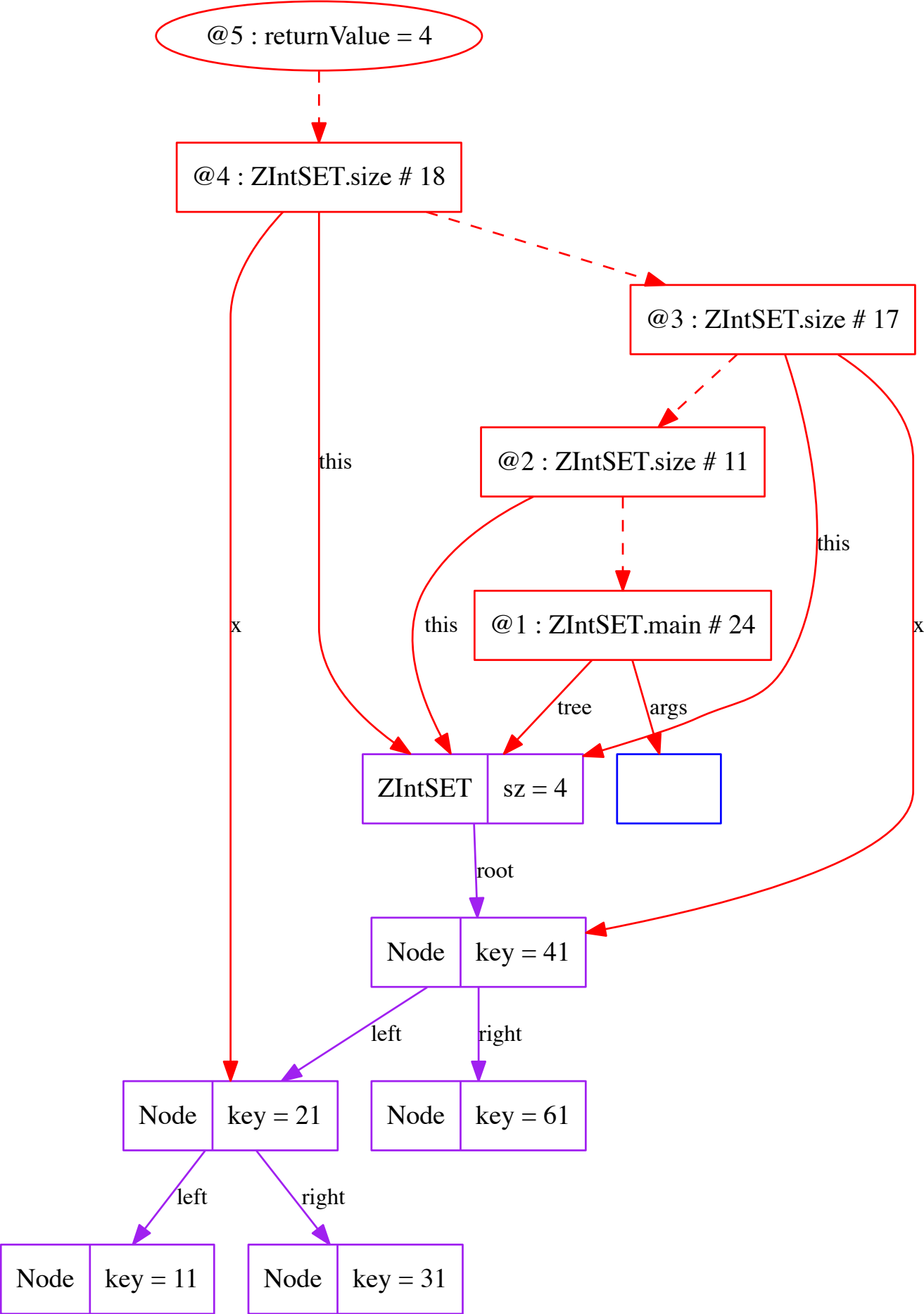

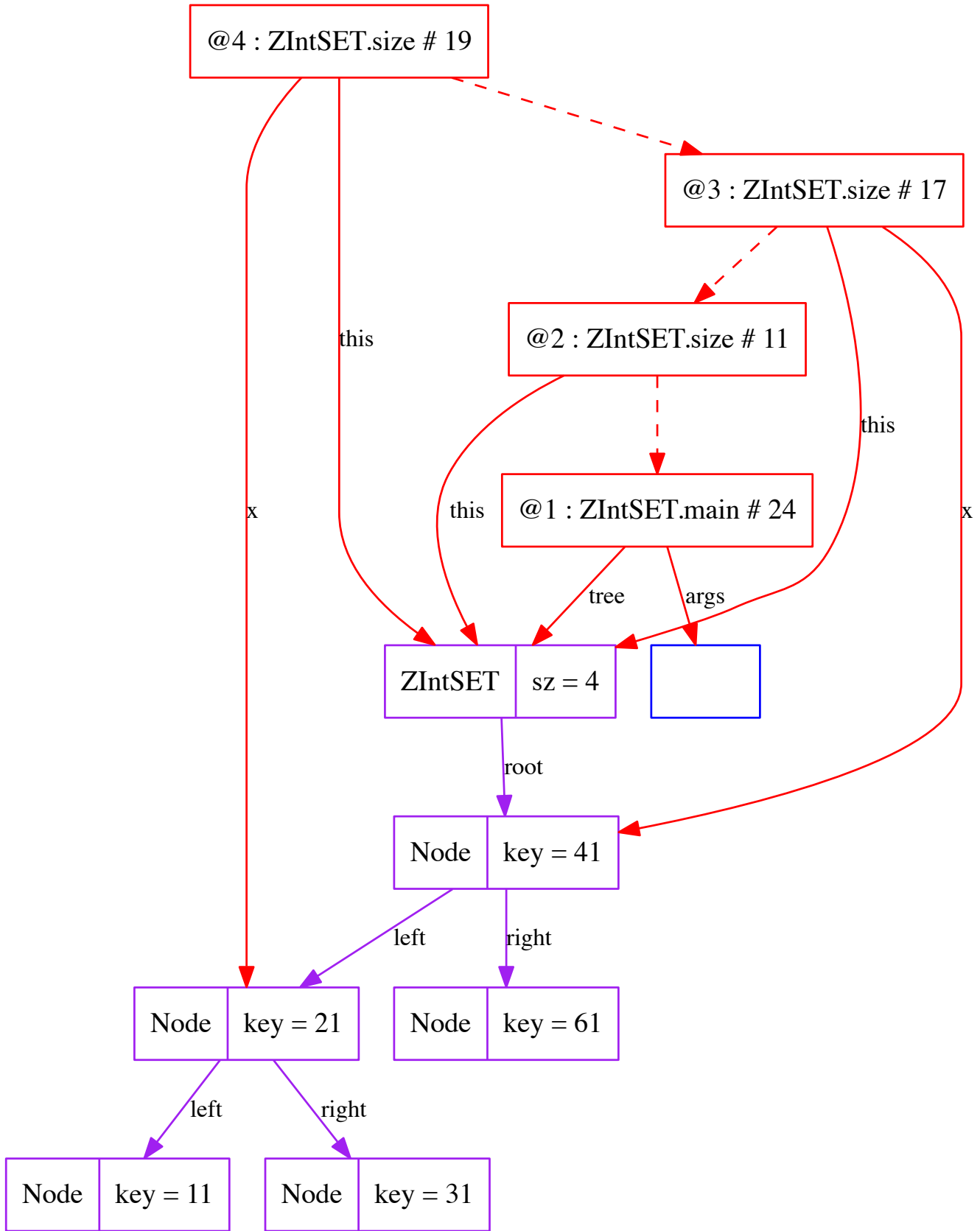

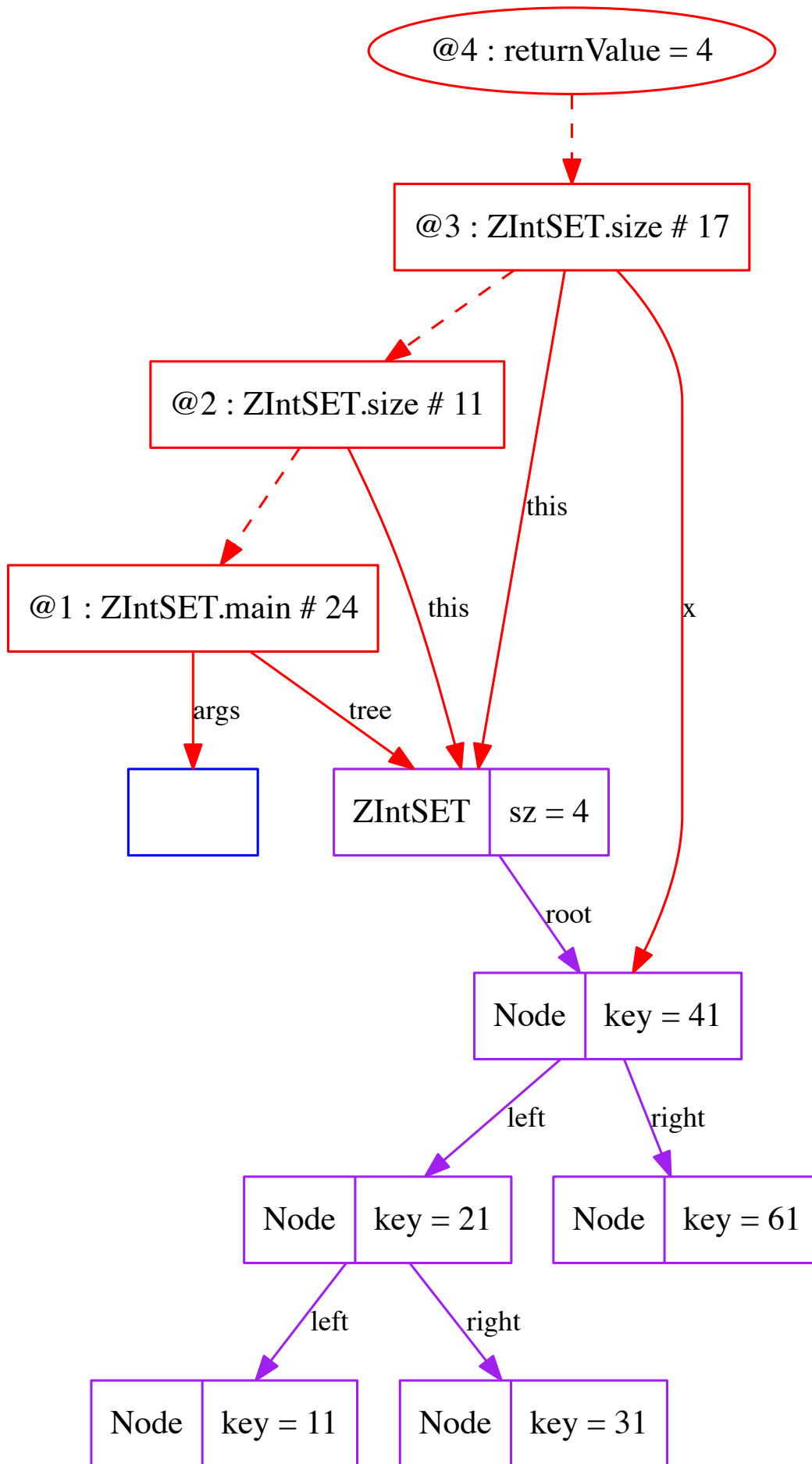

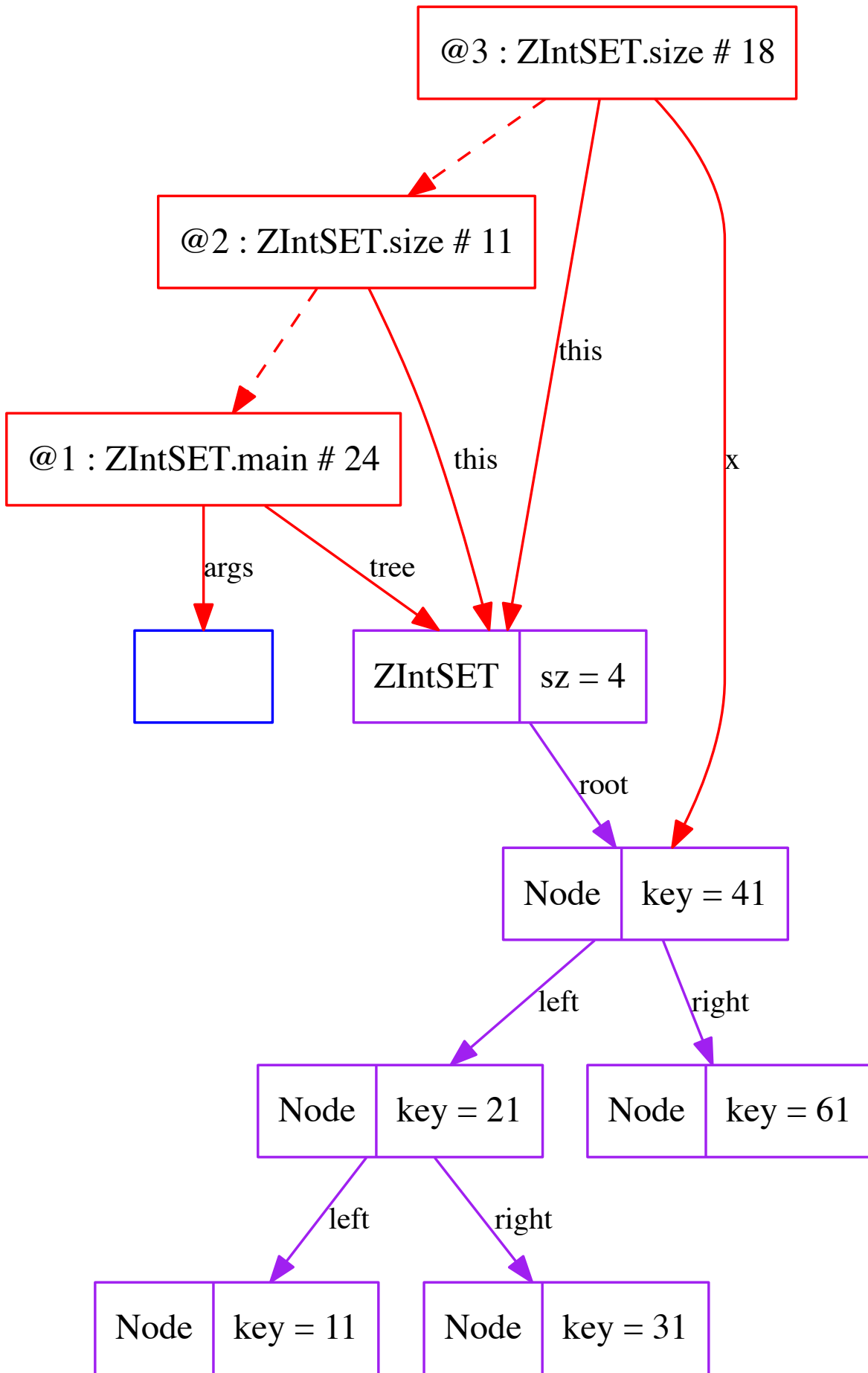

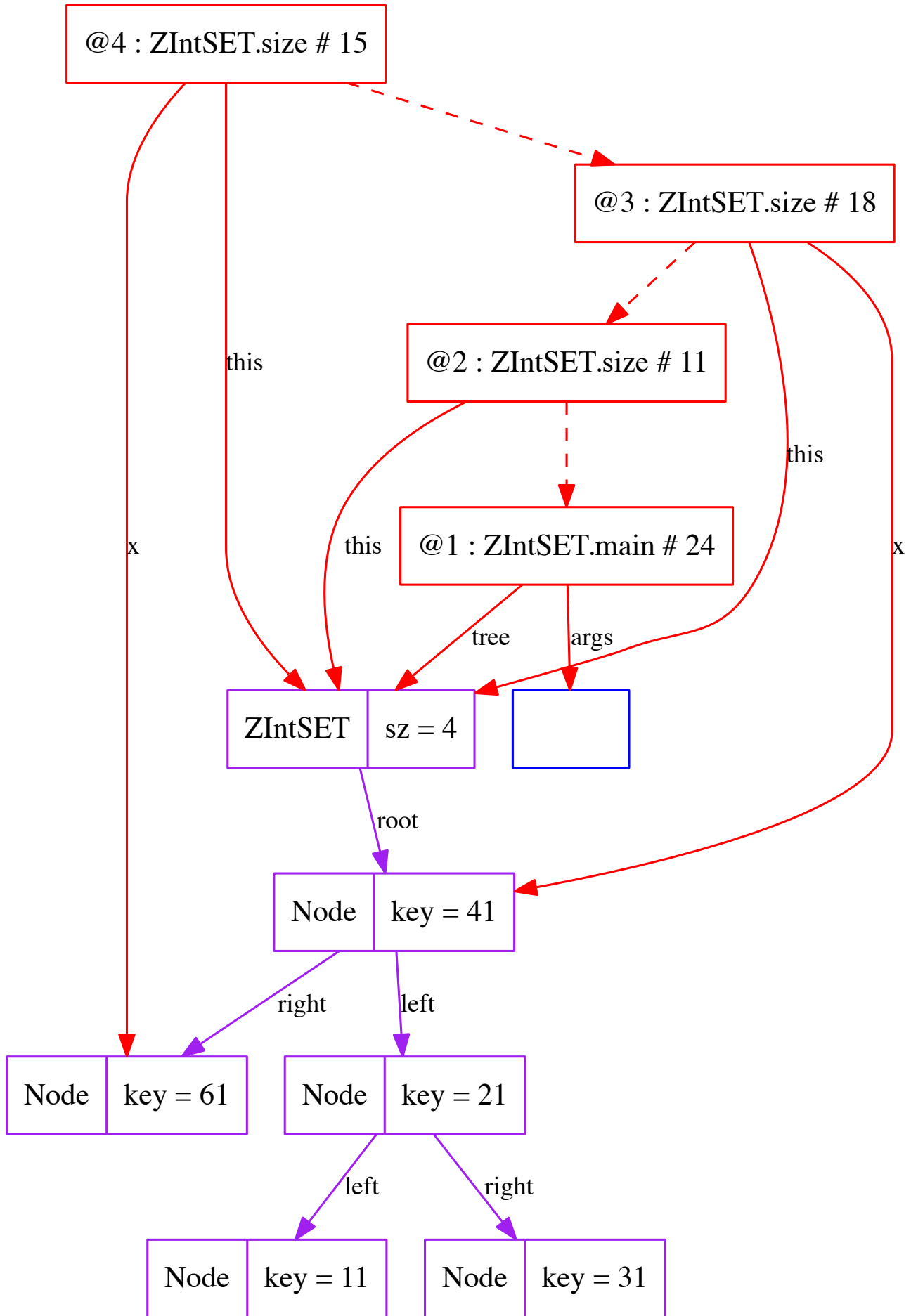

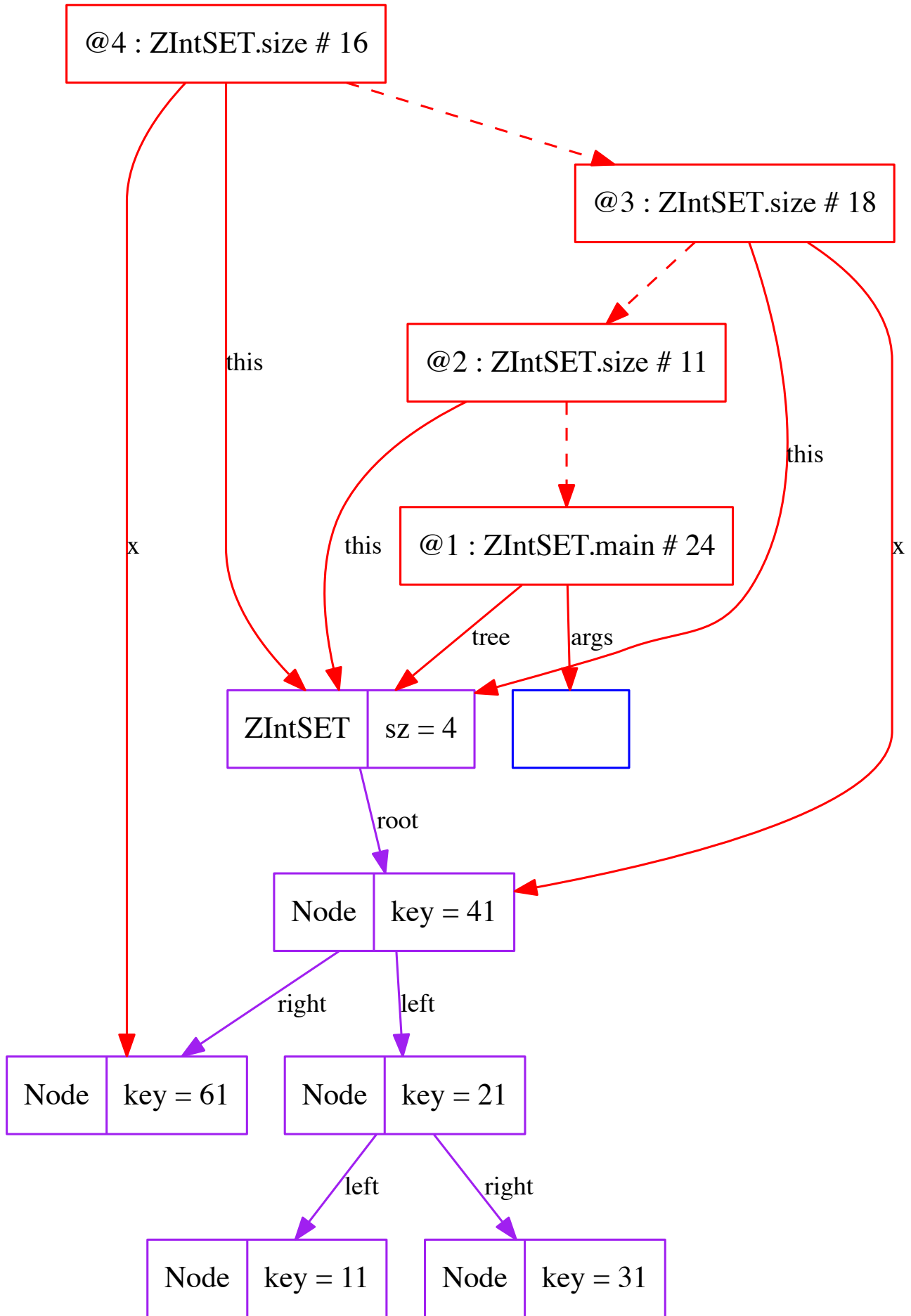

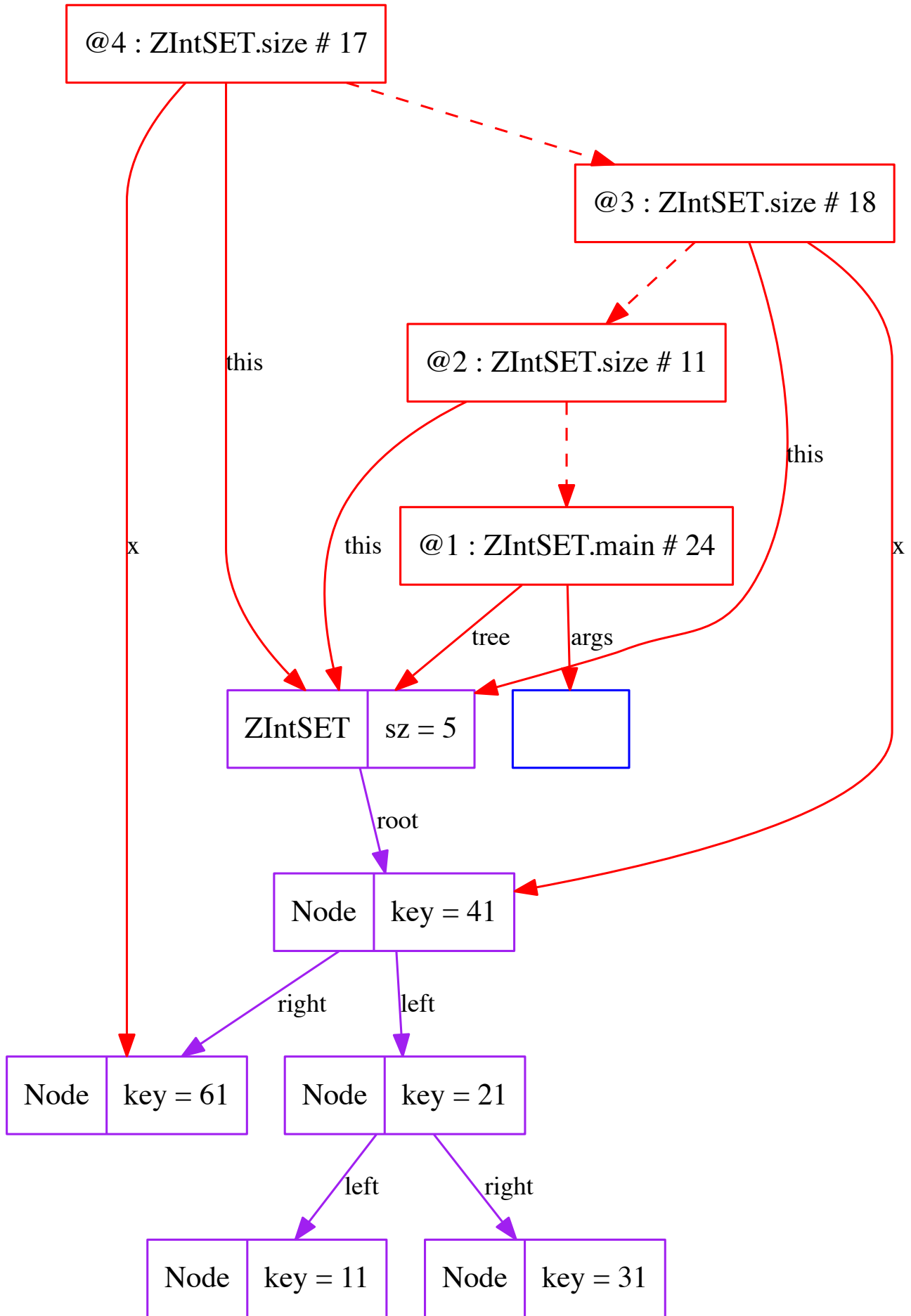

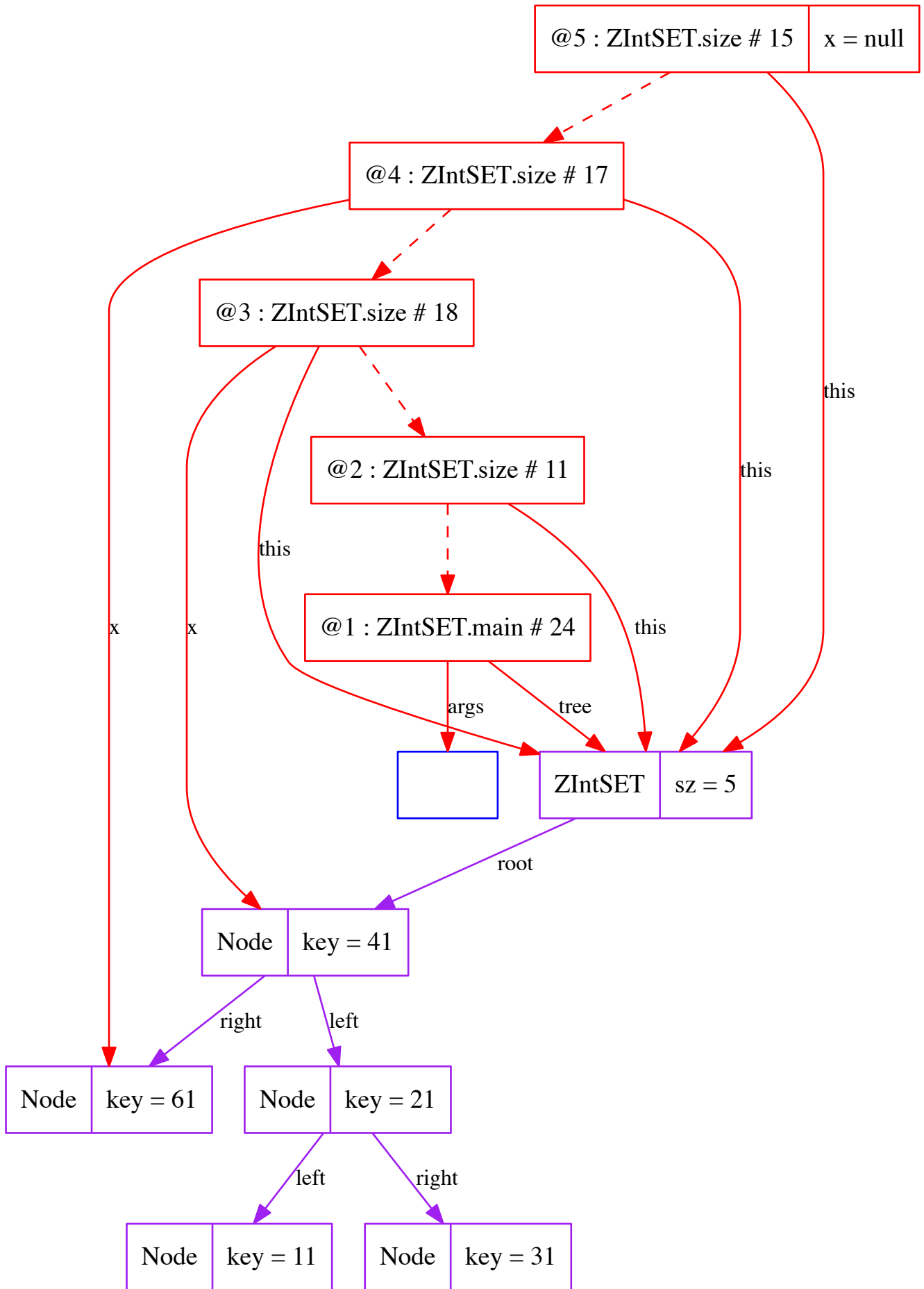

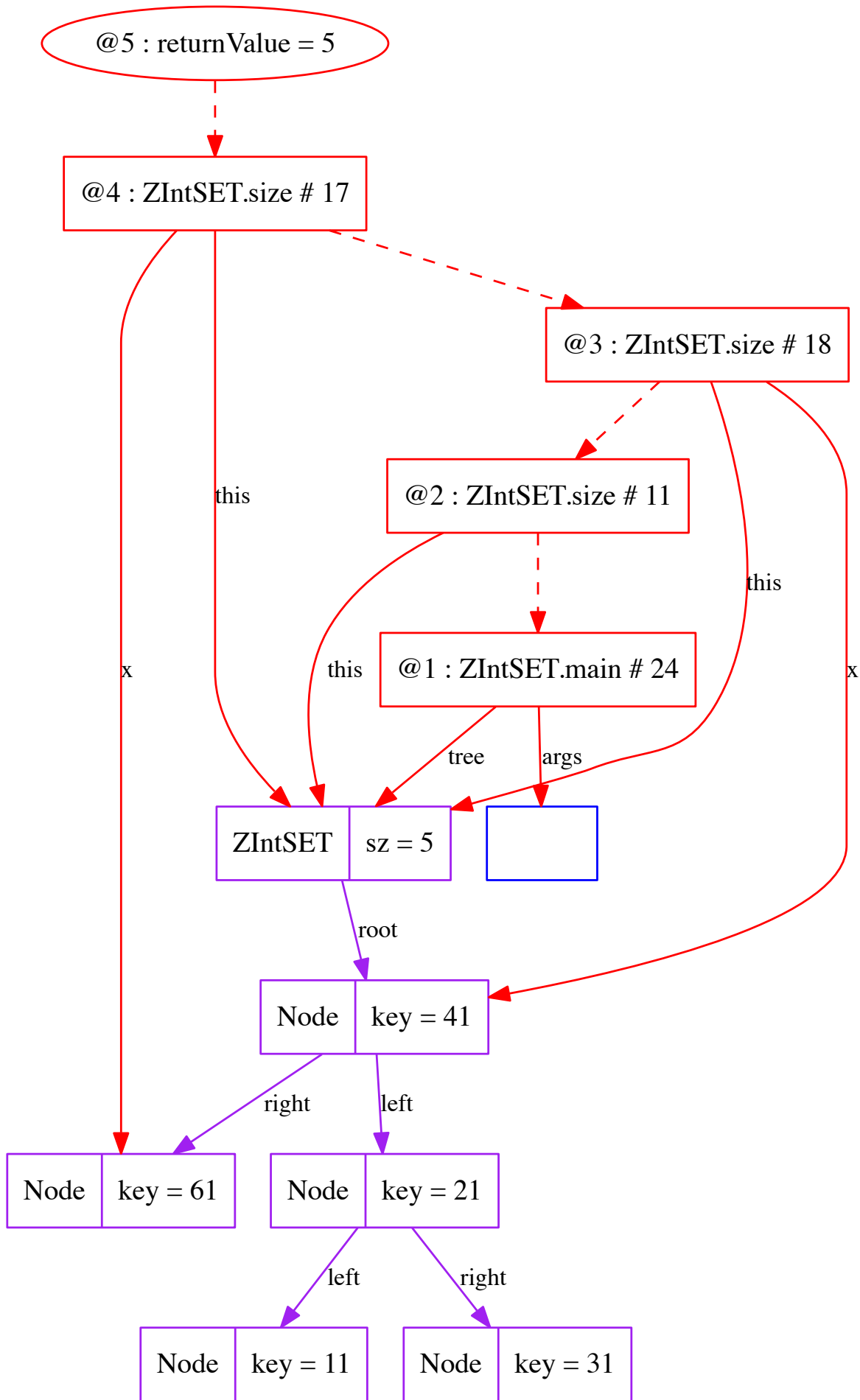

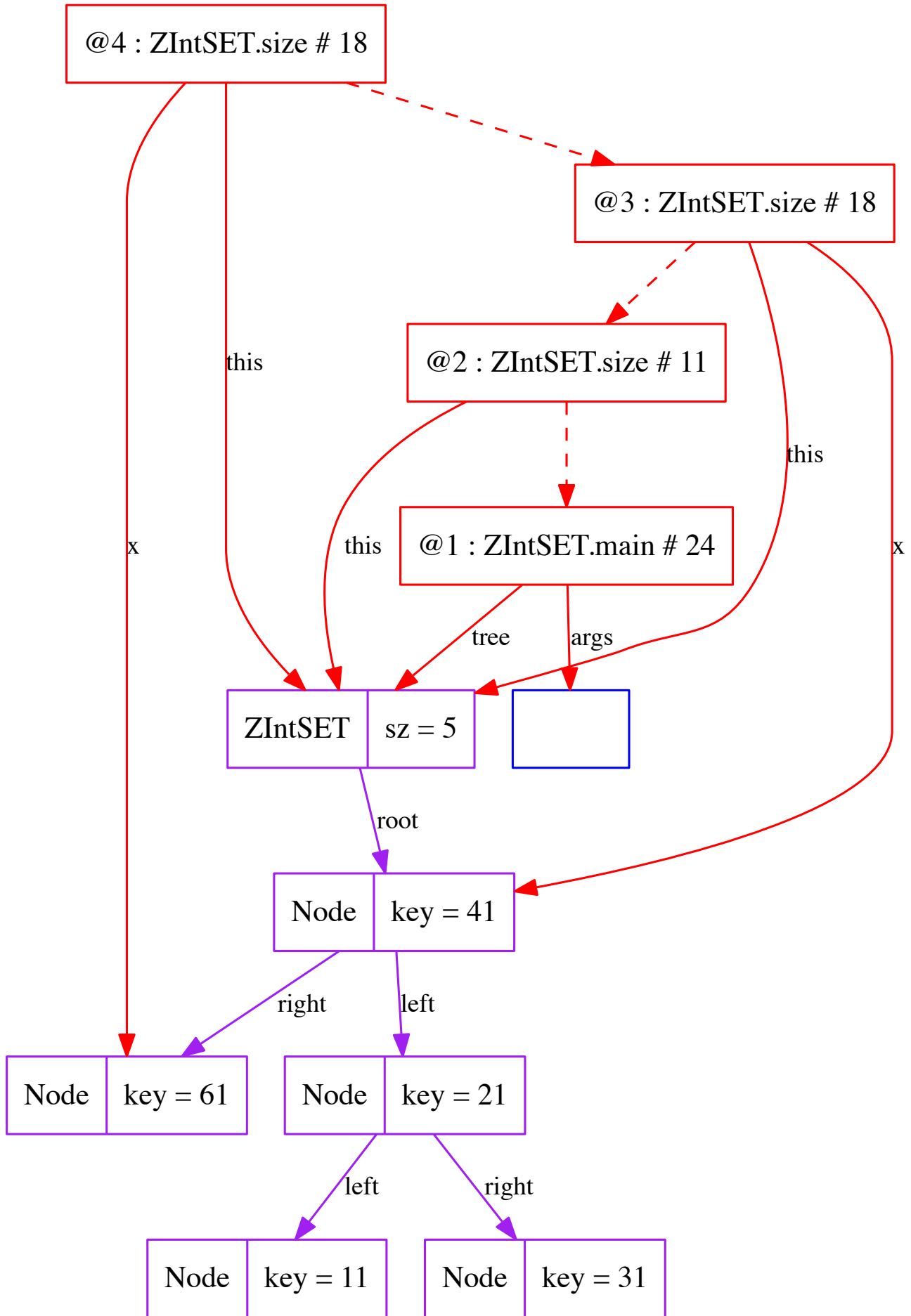

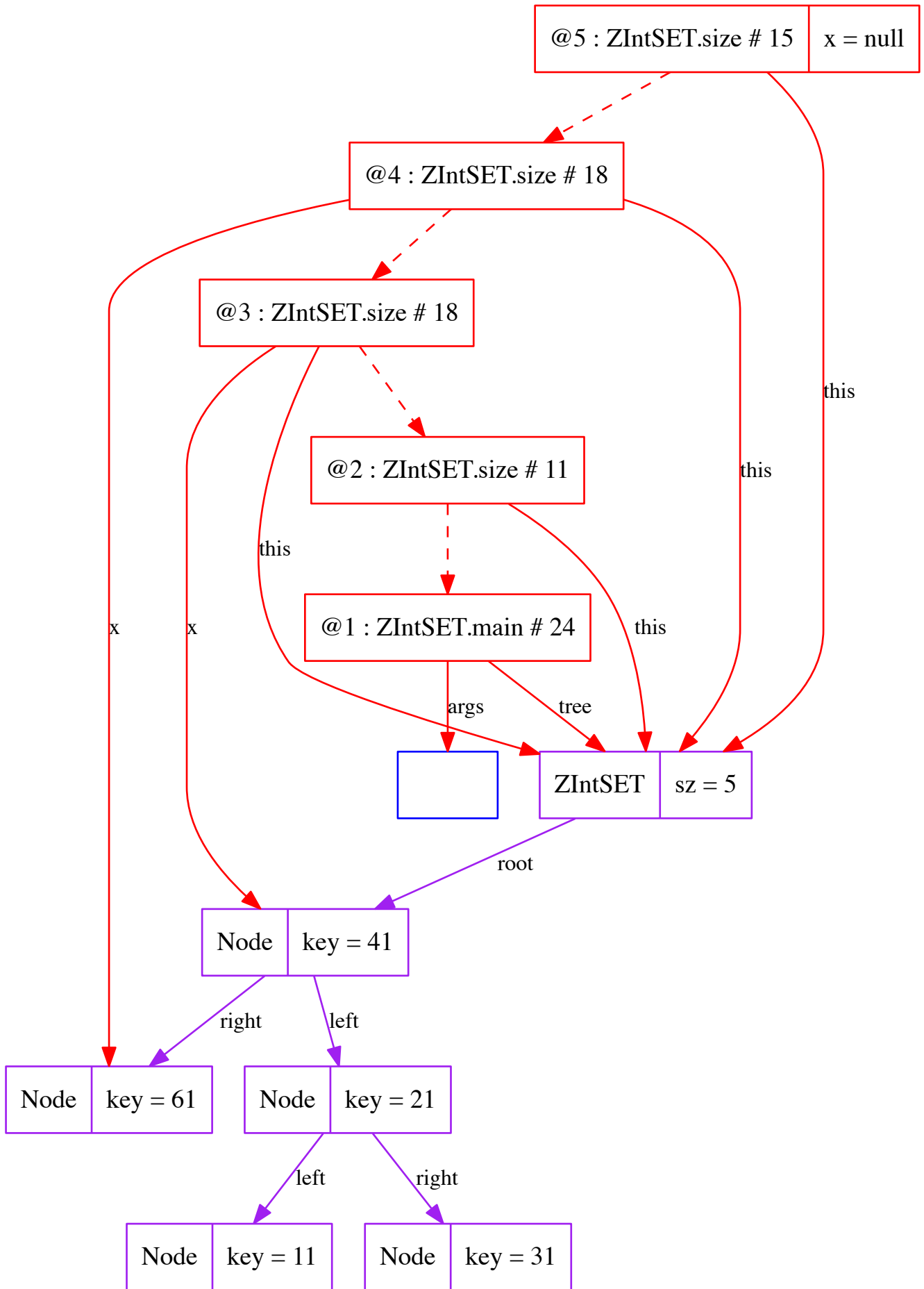

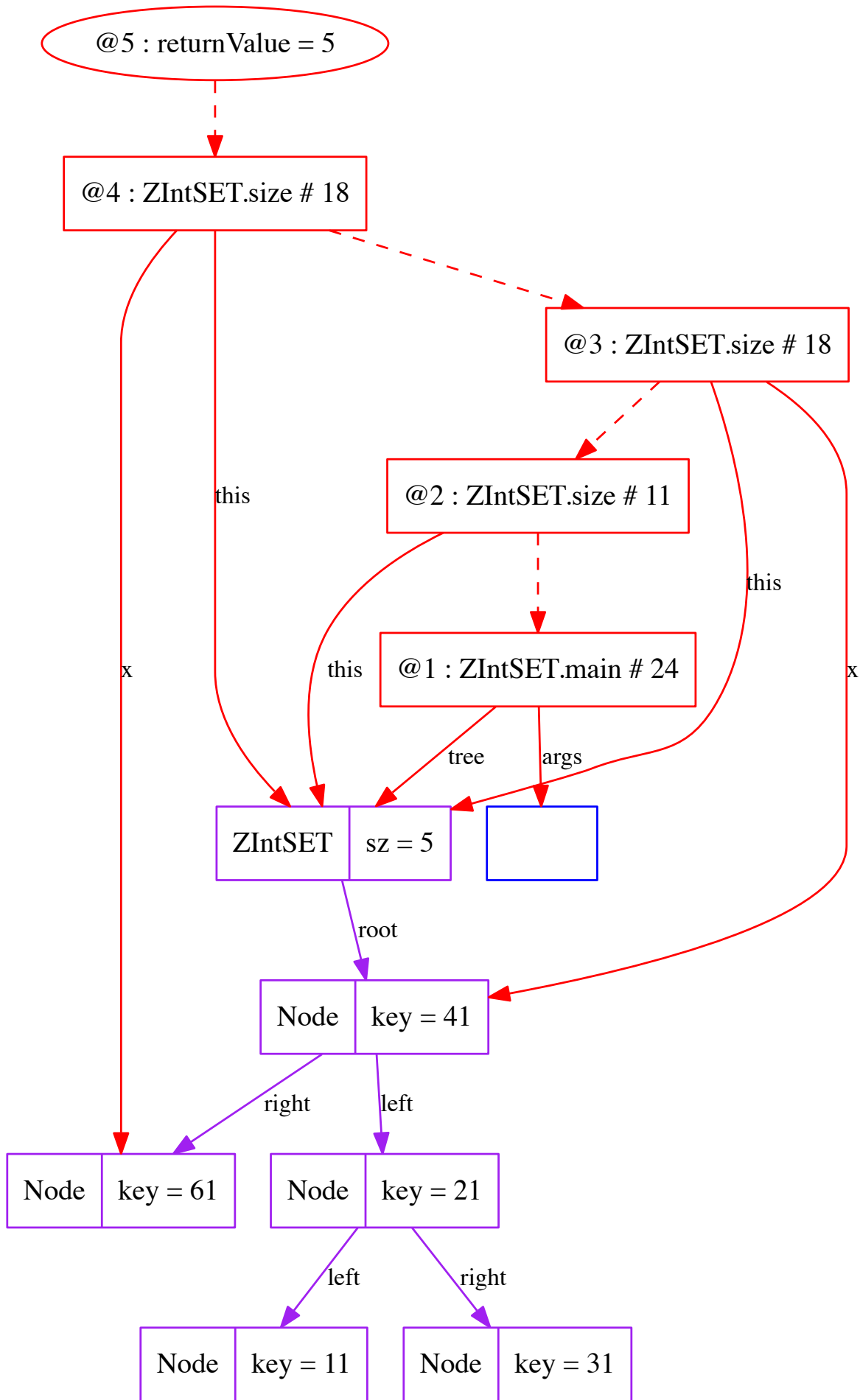

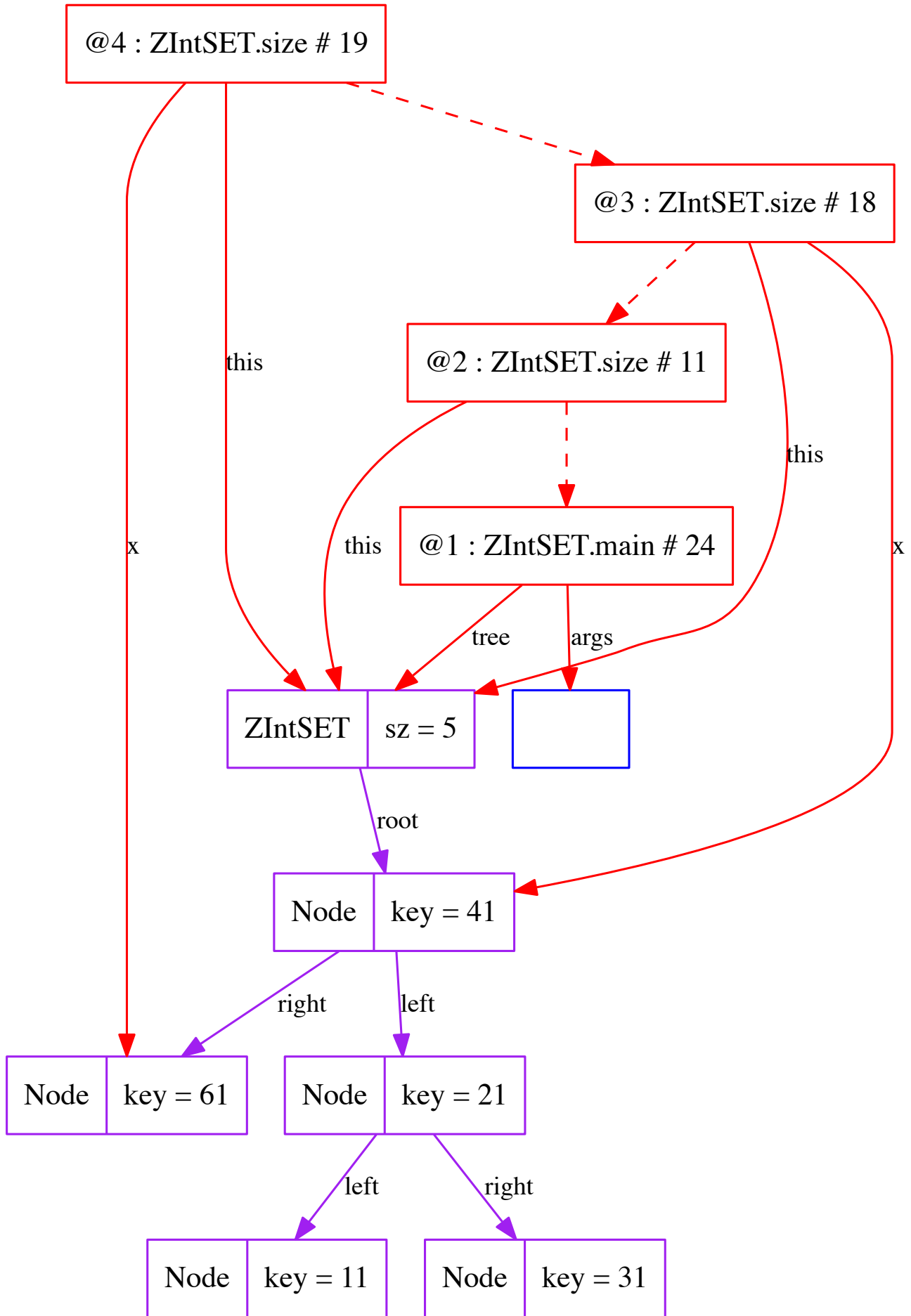

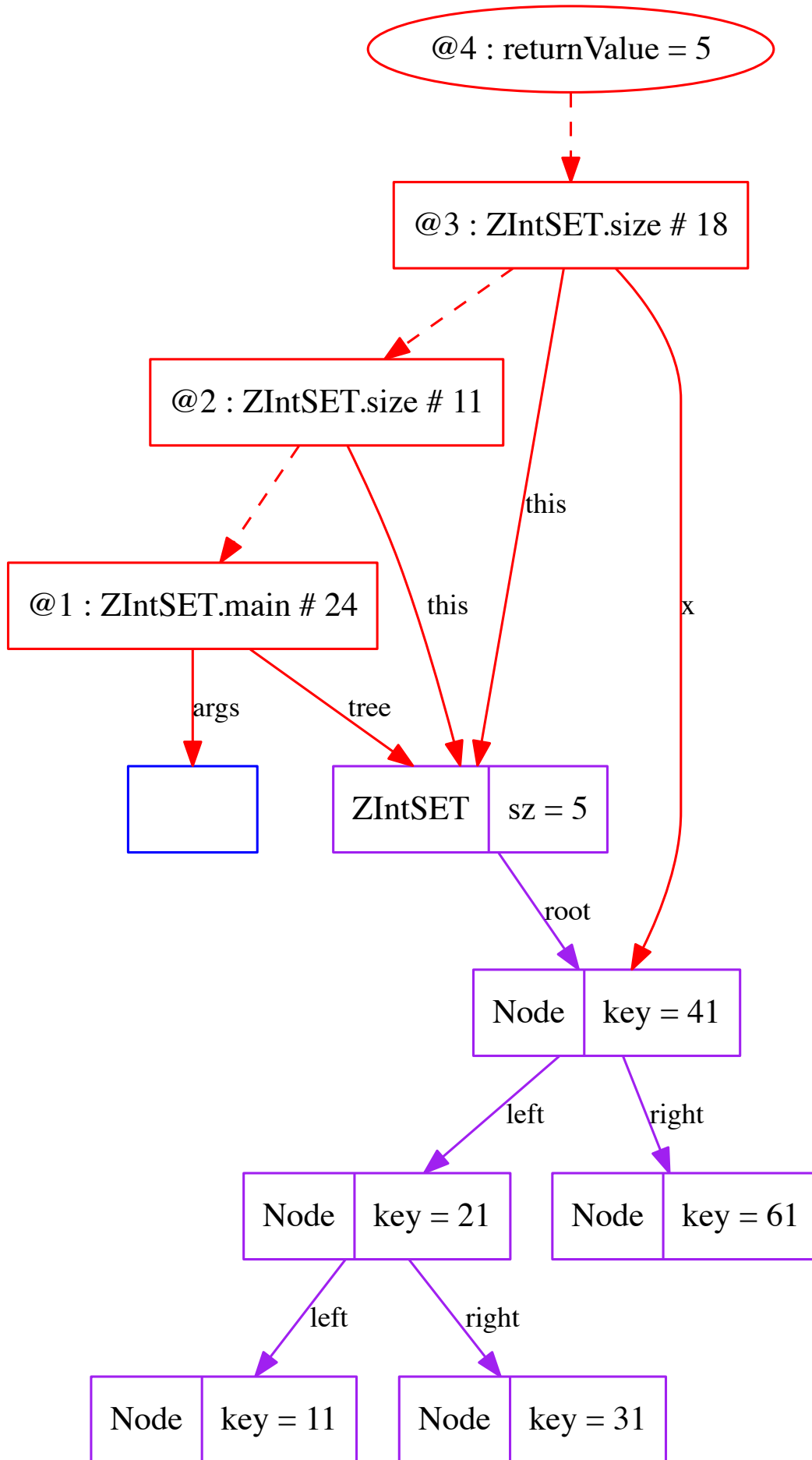

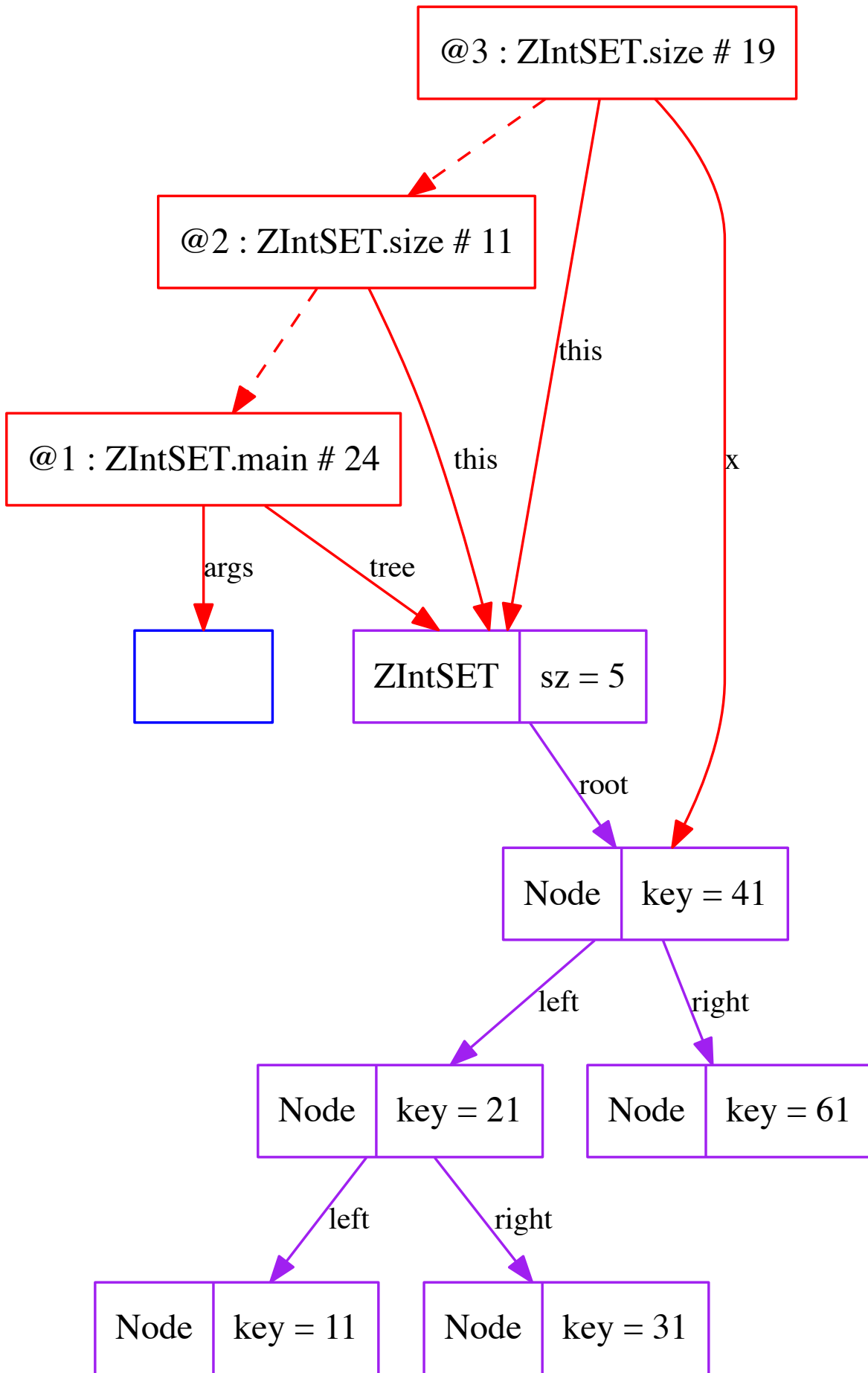

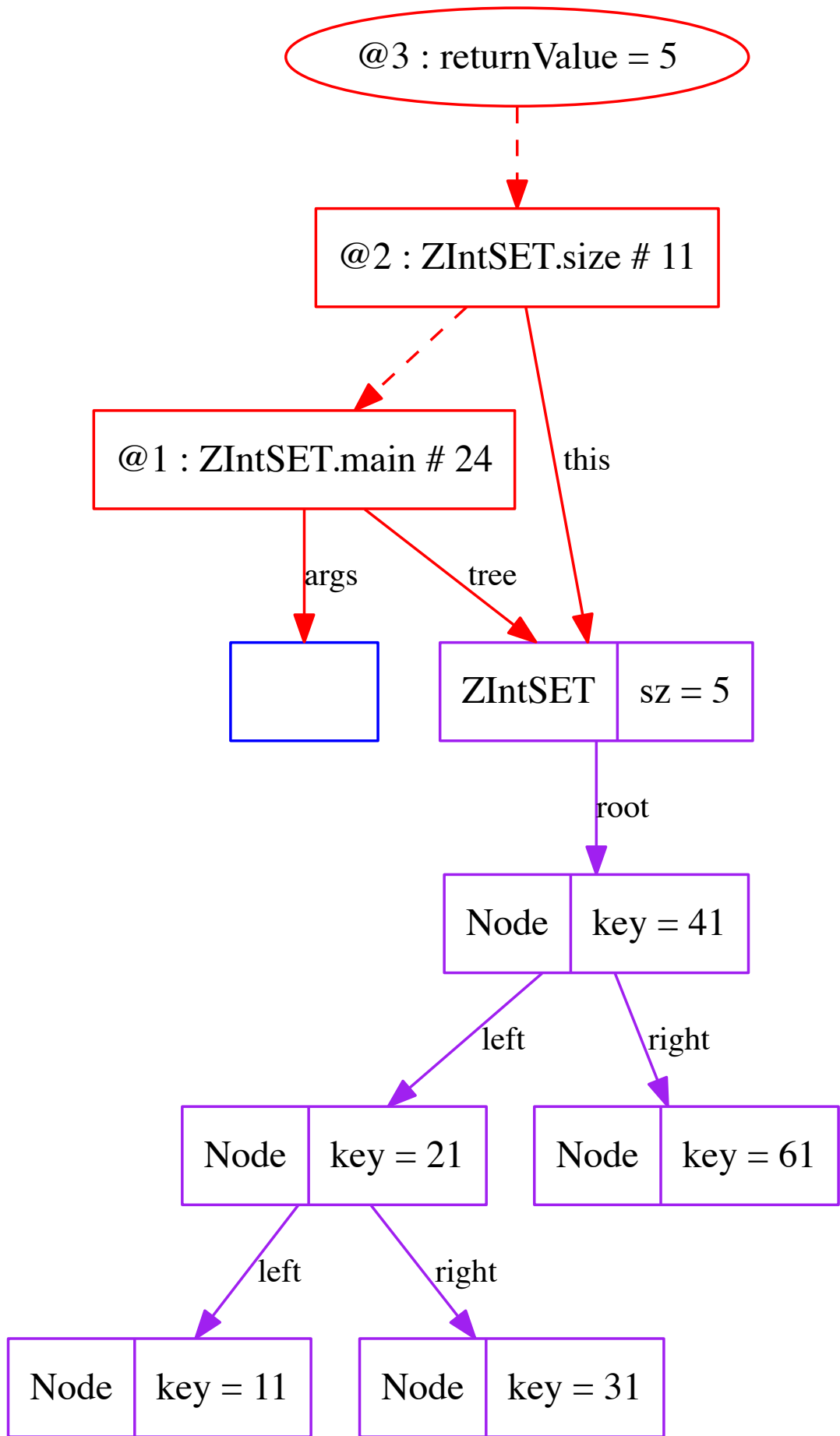

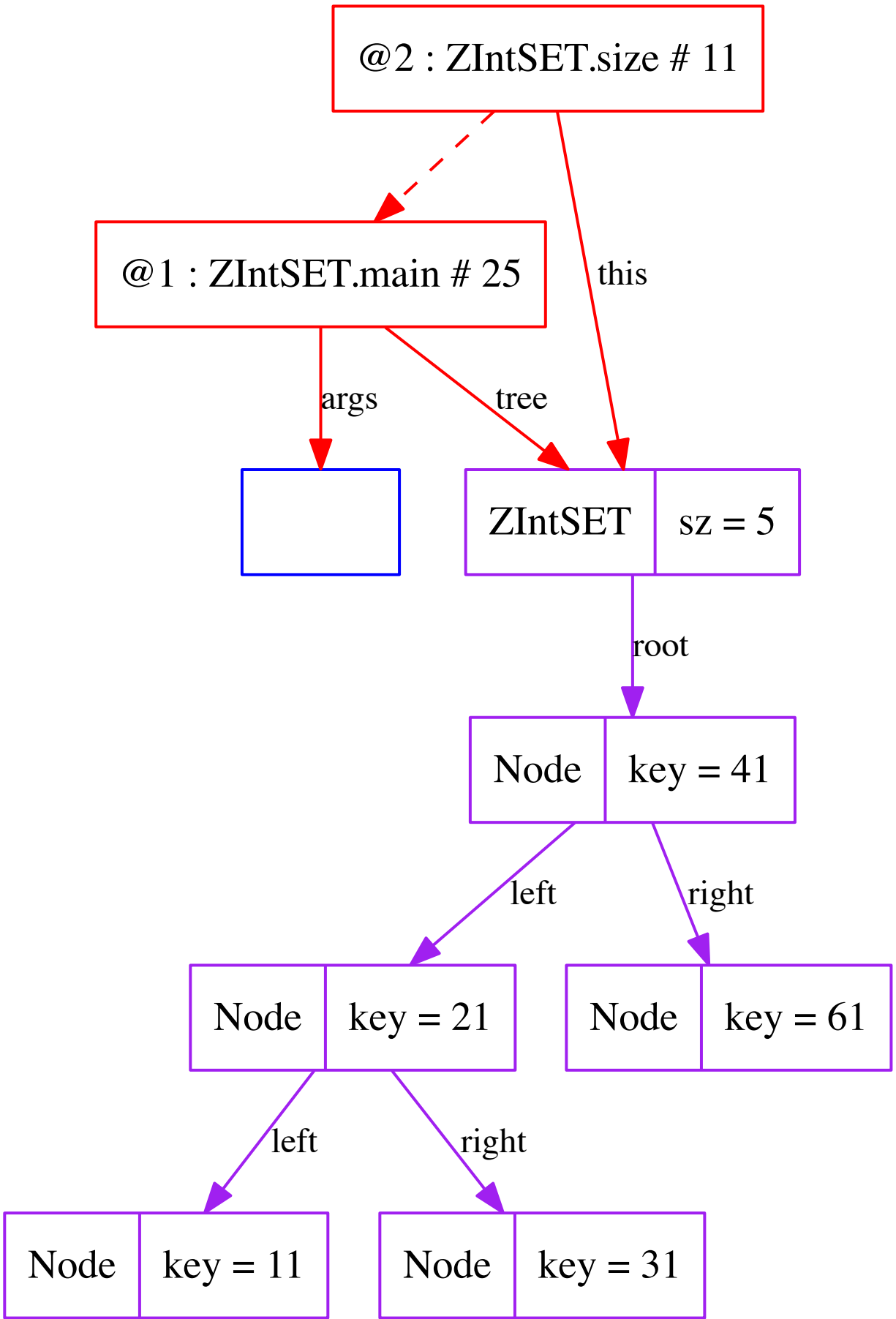

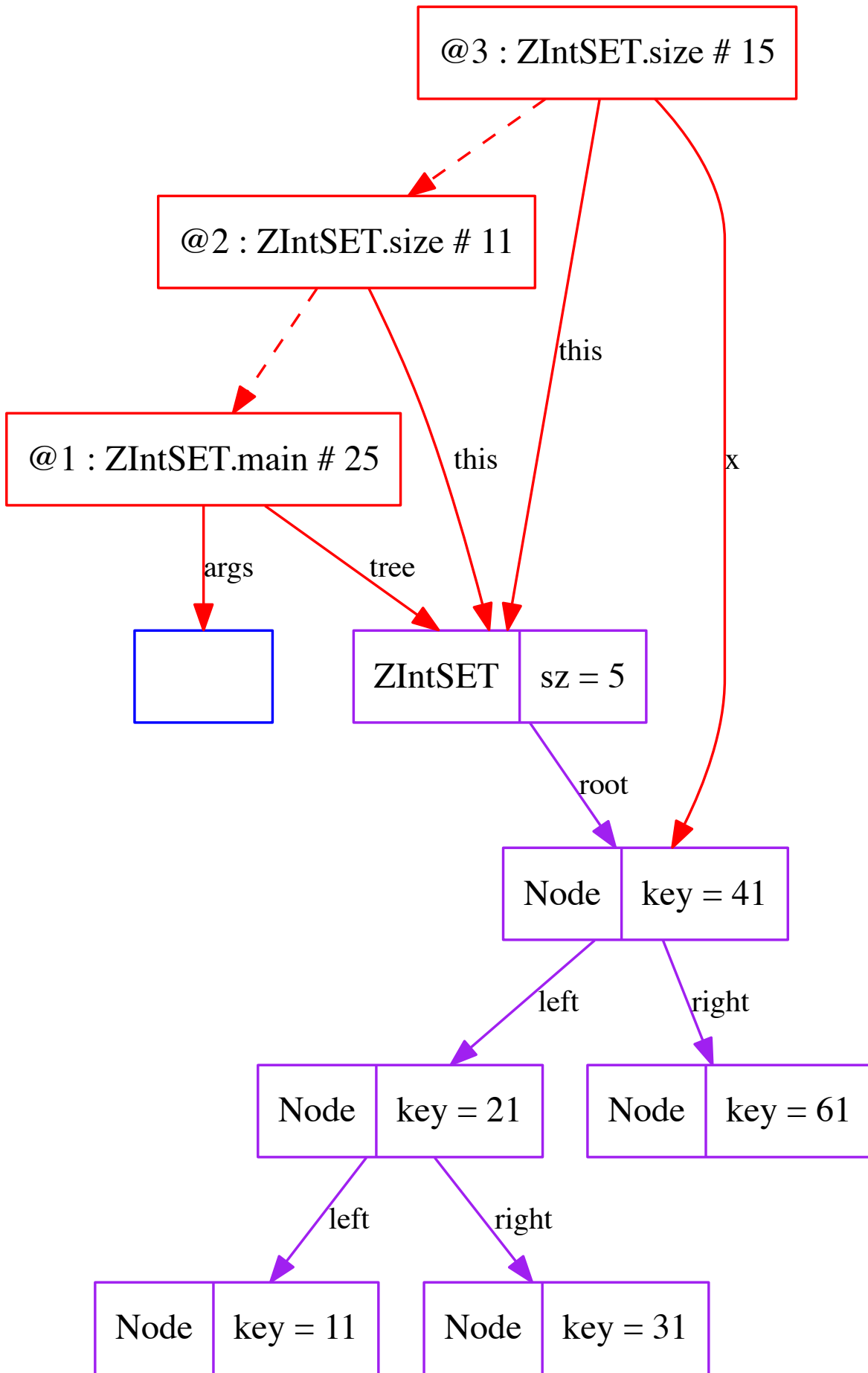

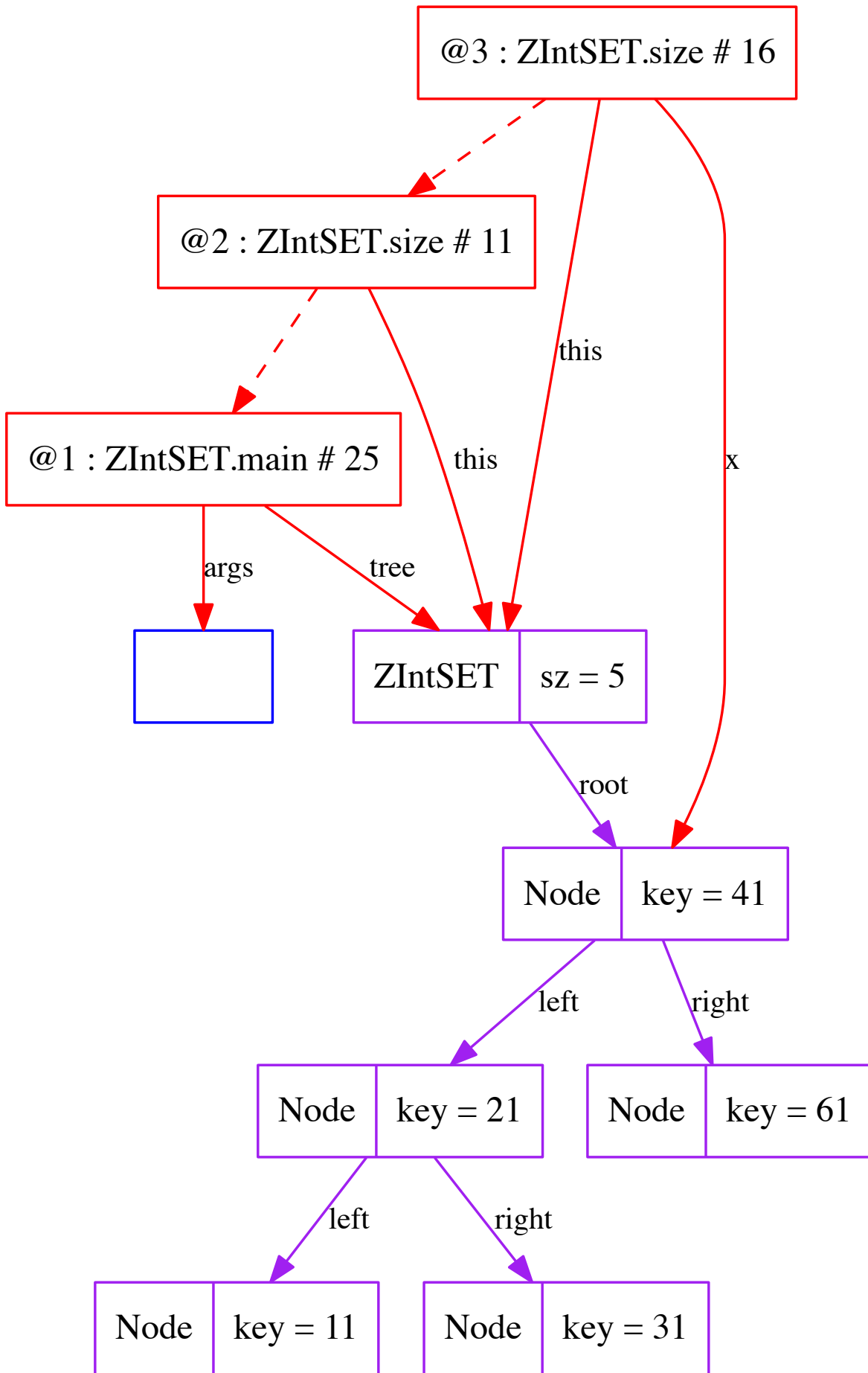

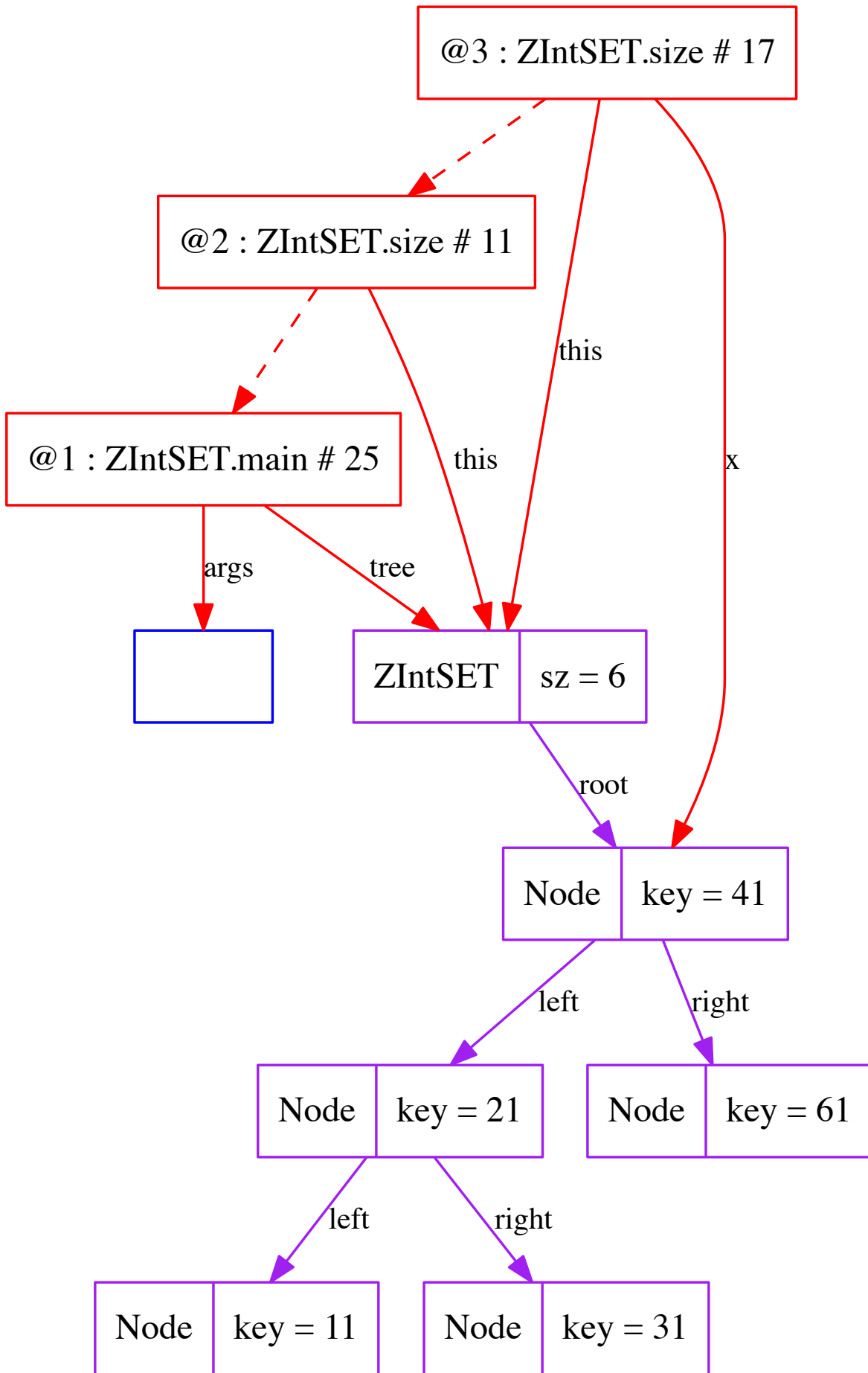

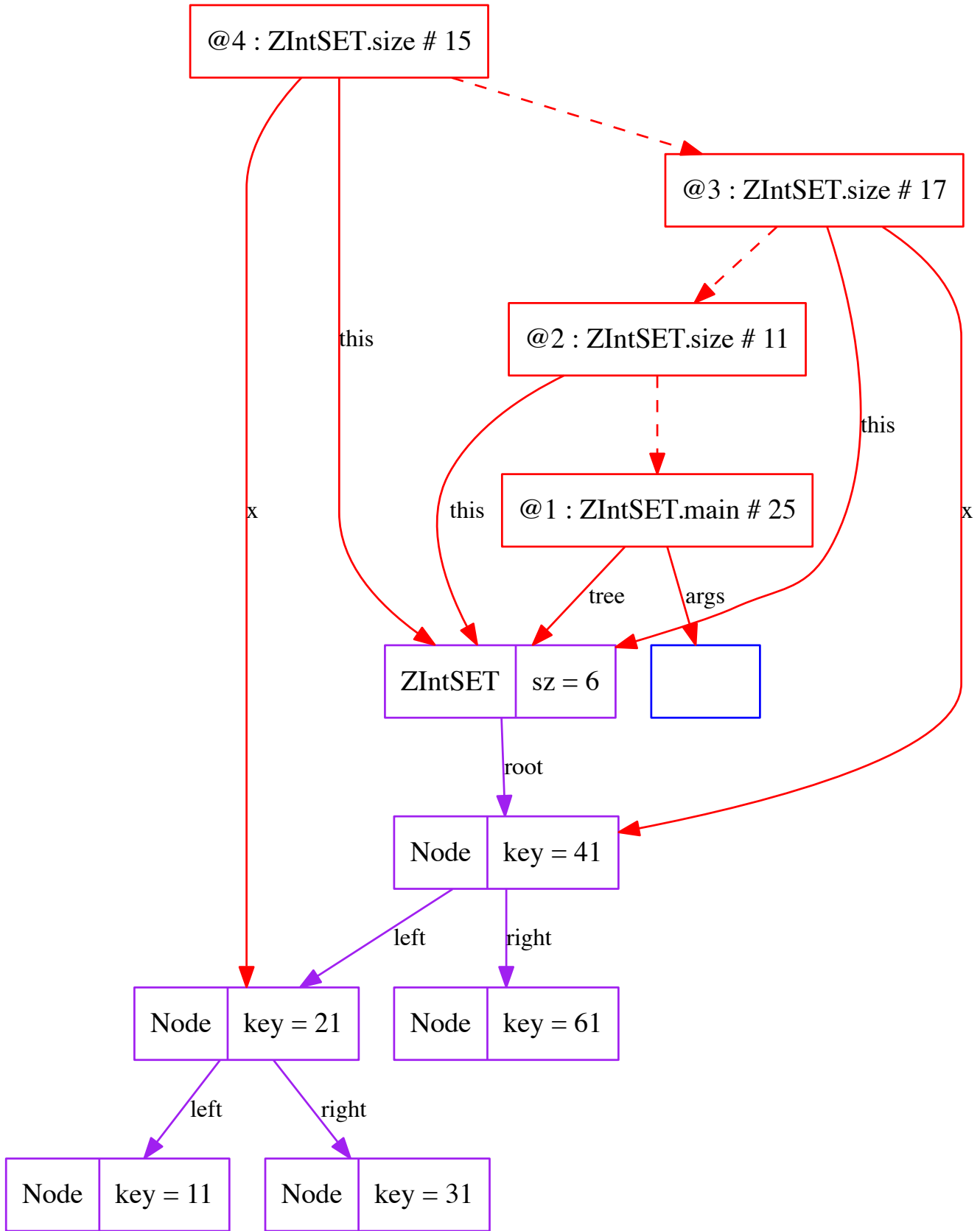

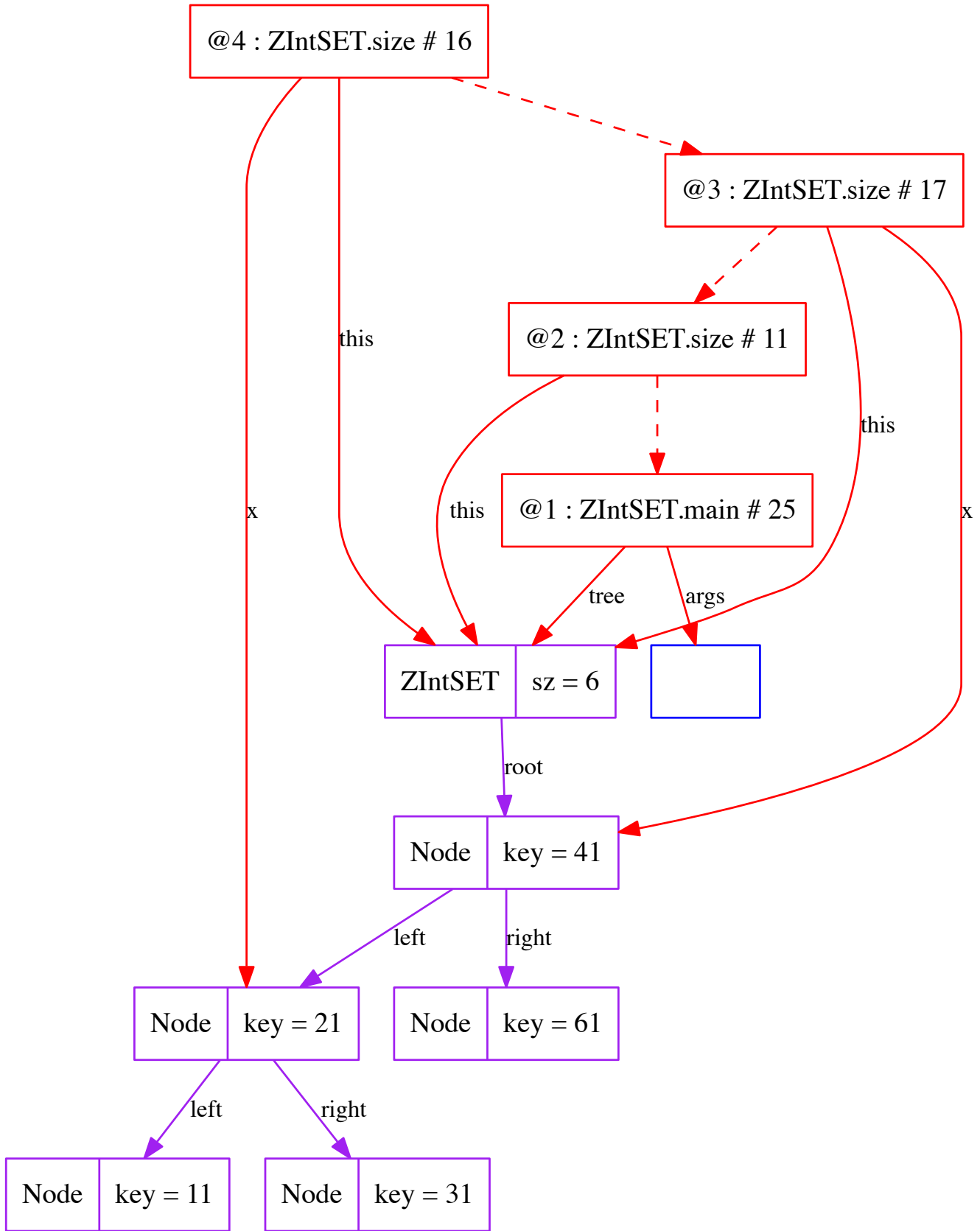

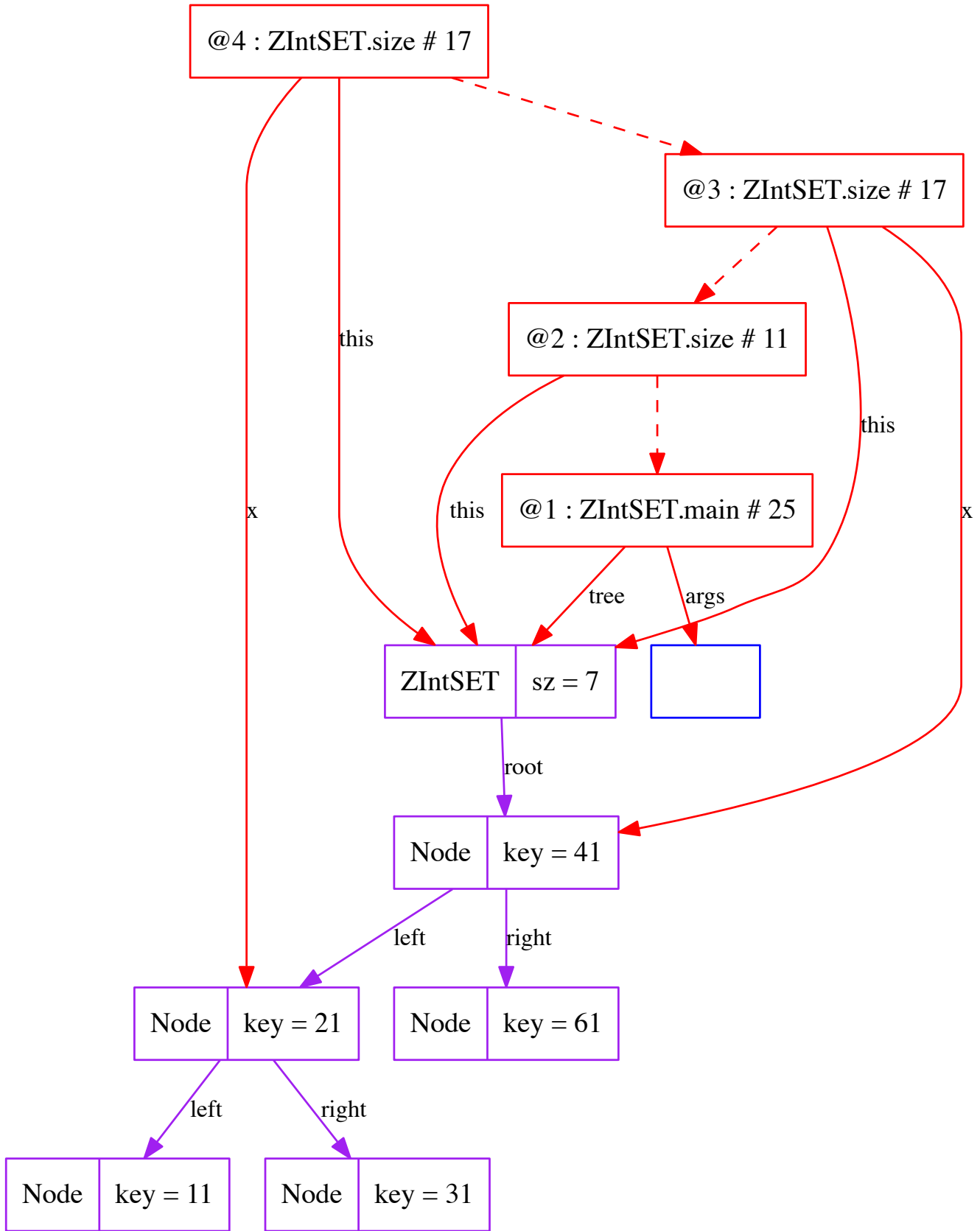

@5 : ZIntSET.size # 15

@4 : ZIntSET.size # 17

@3 : ZIntSET.size # 17

@2 : ZIntSET.size # 11

@1 : ZIntSET.main # 25

[]

ZIntSET sz = 7

Node key = 41

Node key = 61

Node key = 21

Node key = 11

Node key = 31

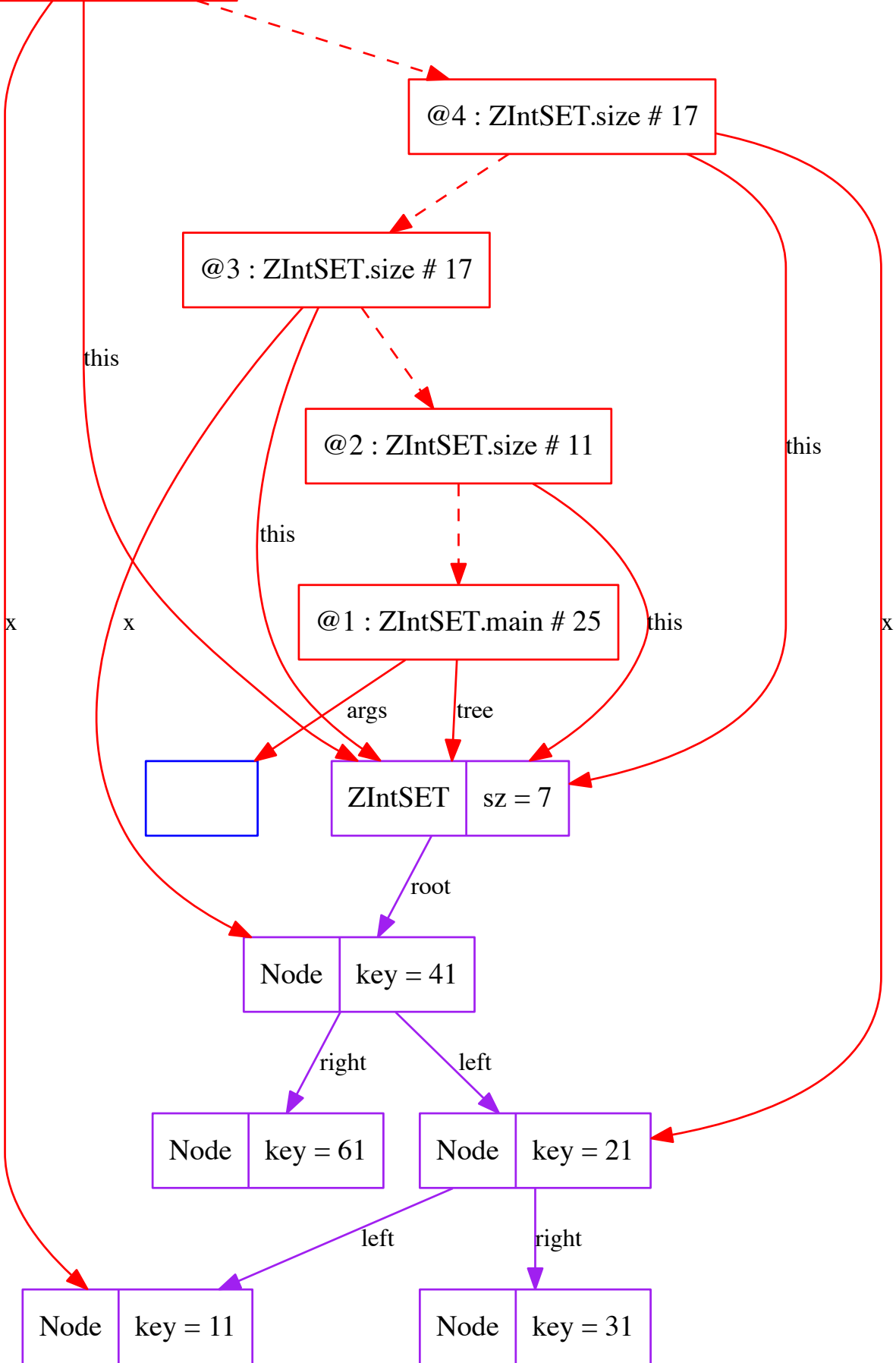

@5 : ZIntSET.size # 16

@4 : ZIntSET.size # 17

@3 : ZIntSET.size # 17

@2 : ZIntSET.size # 11

@1 : ZIntSET.main # 25

ZIntSET sz = 7

Node key = 41

Node key = 61

Node key = 21

Node key = 11

Node key = 31

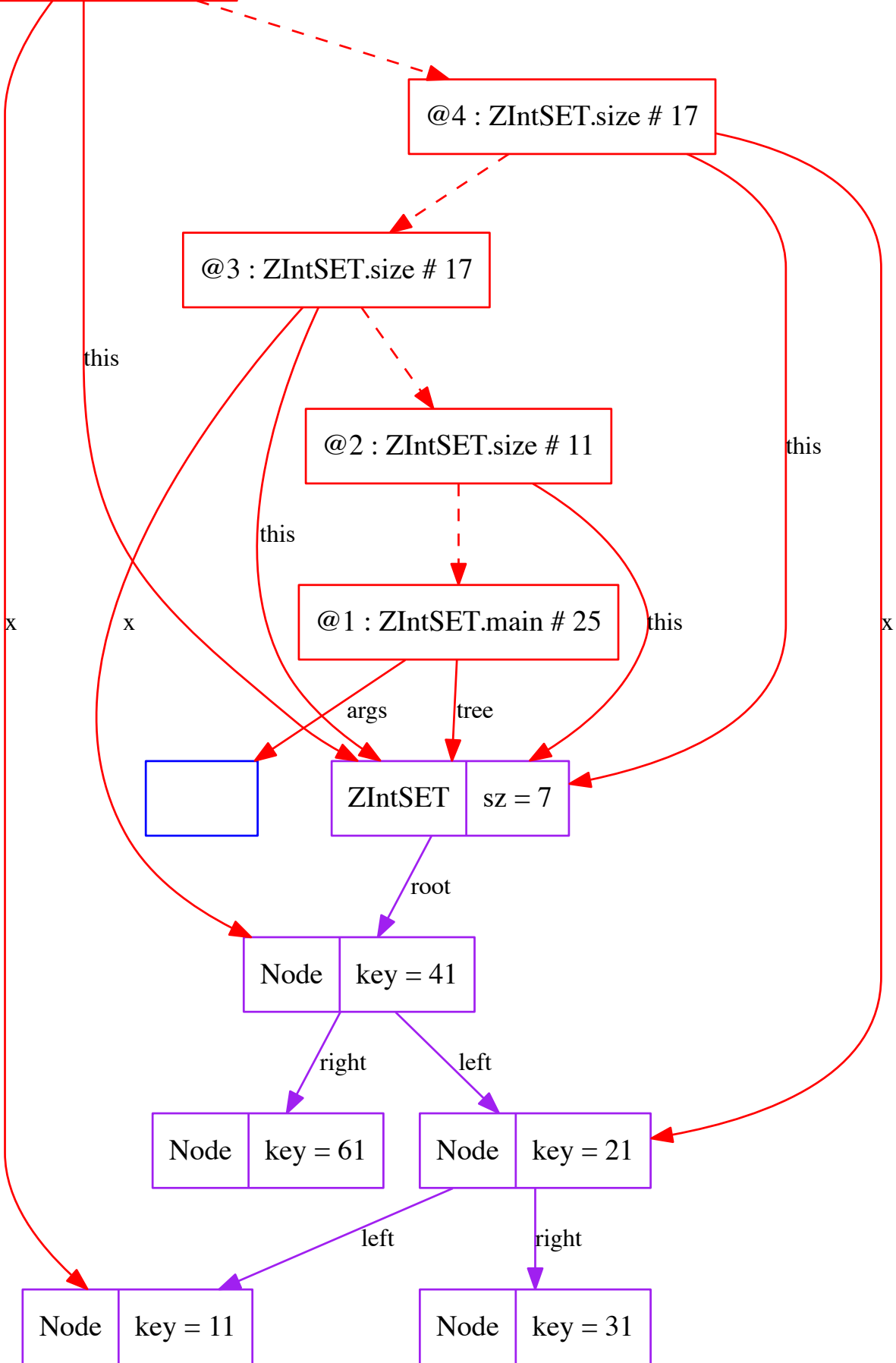

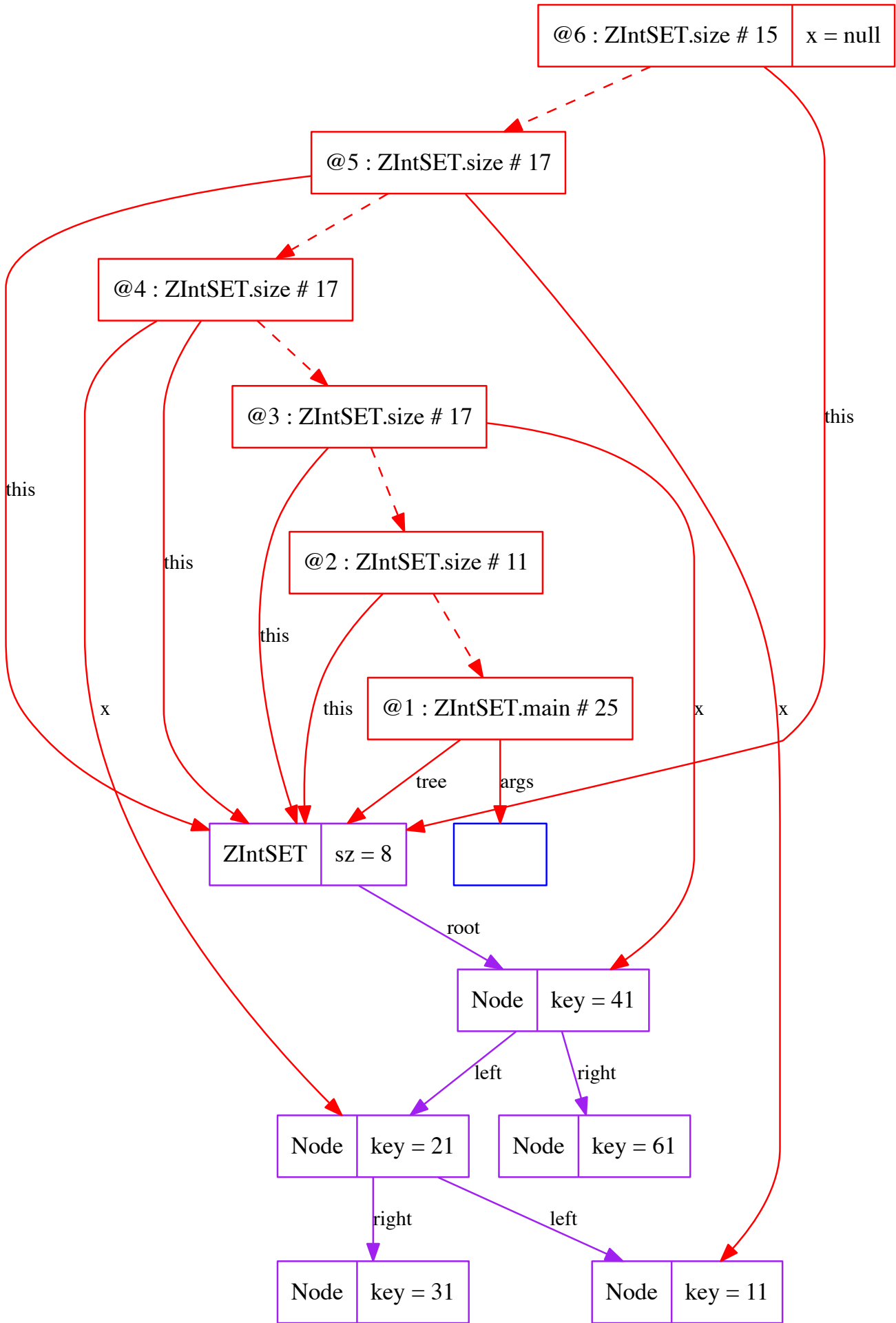

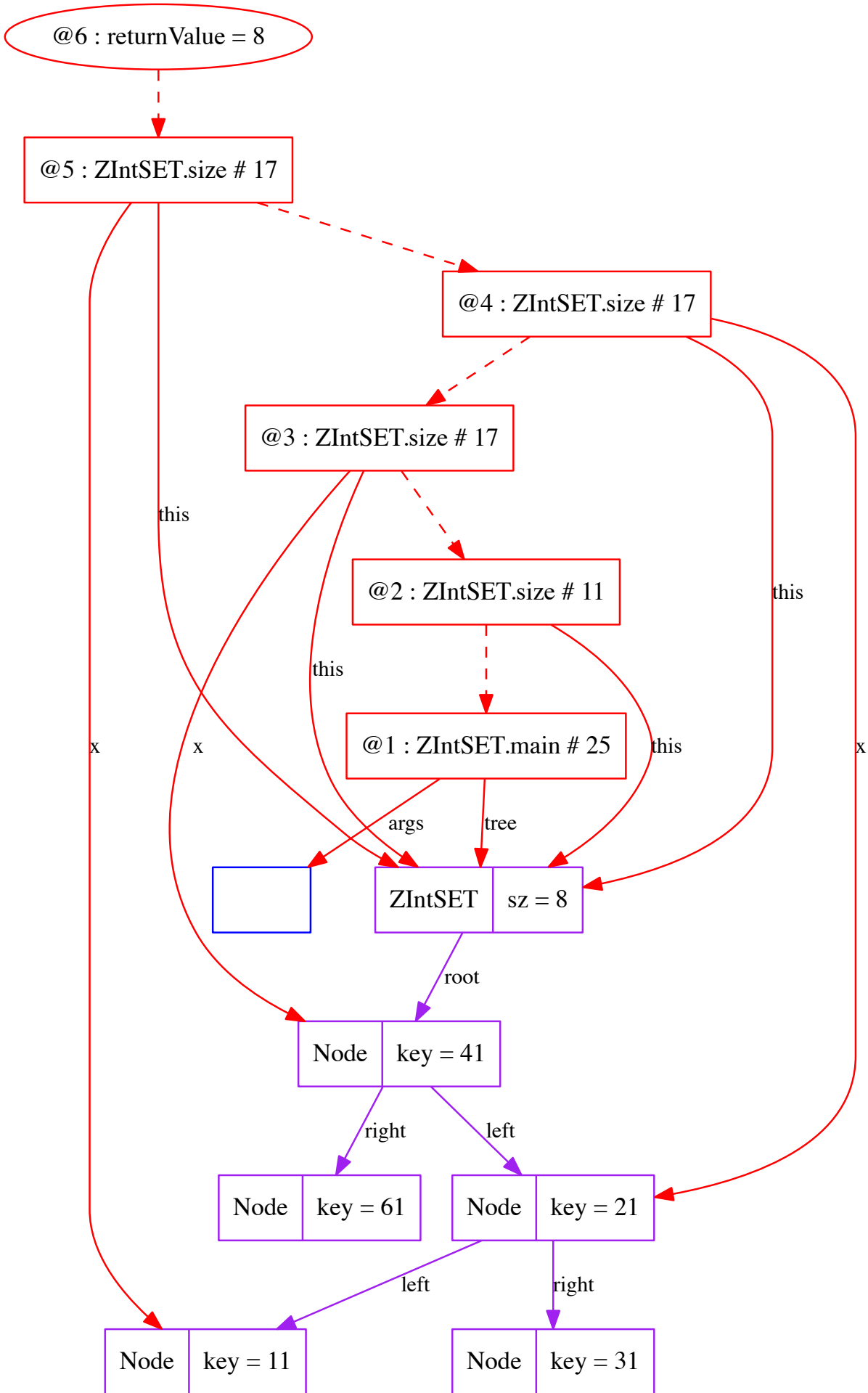

@5 : ZIntSET.size # 18

@4 : ZIntSET.size # 17

@3 : ZIntSET.size # 17

@2 : ZIntSET.size # 11

@1 : ZIntSET.main # 25

ZIntSET sz = 8

Node key = 41

Node key = 61

Node key = 21

Node key = 11

Node key = 31

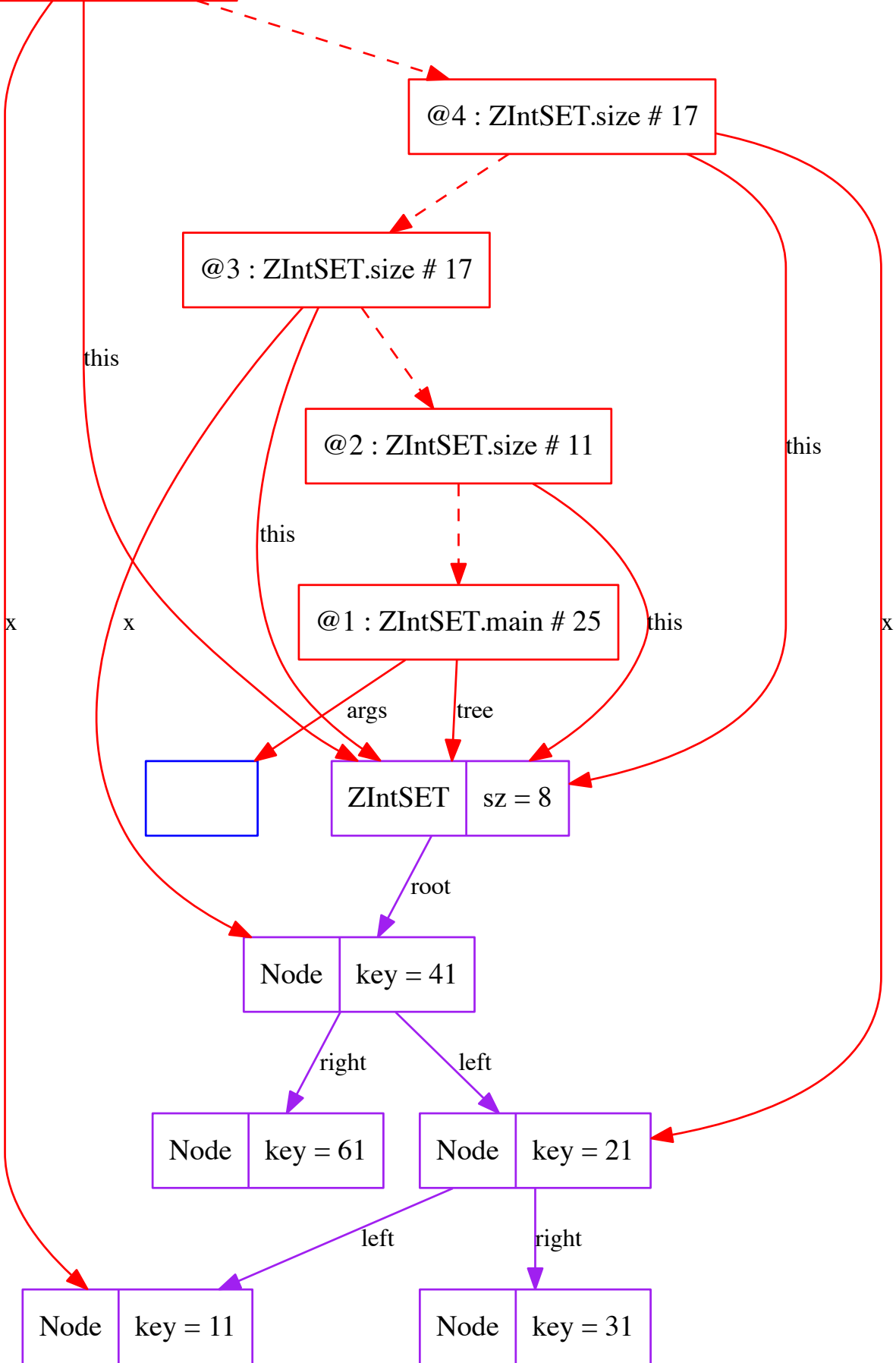

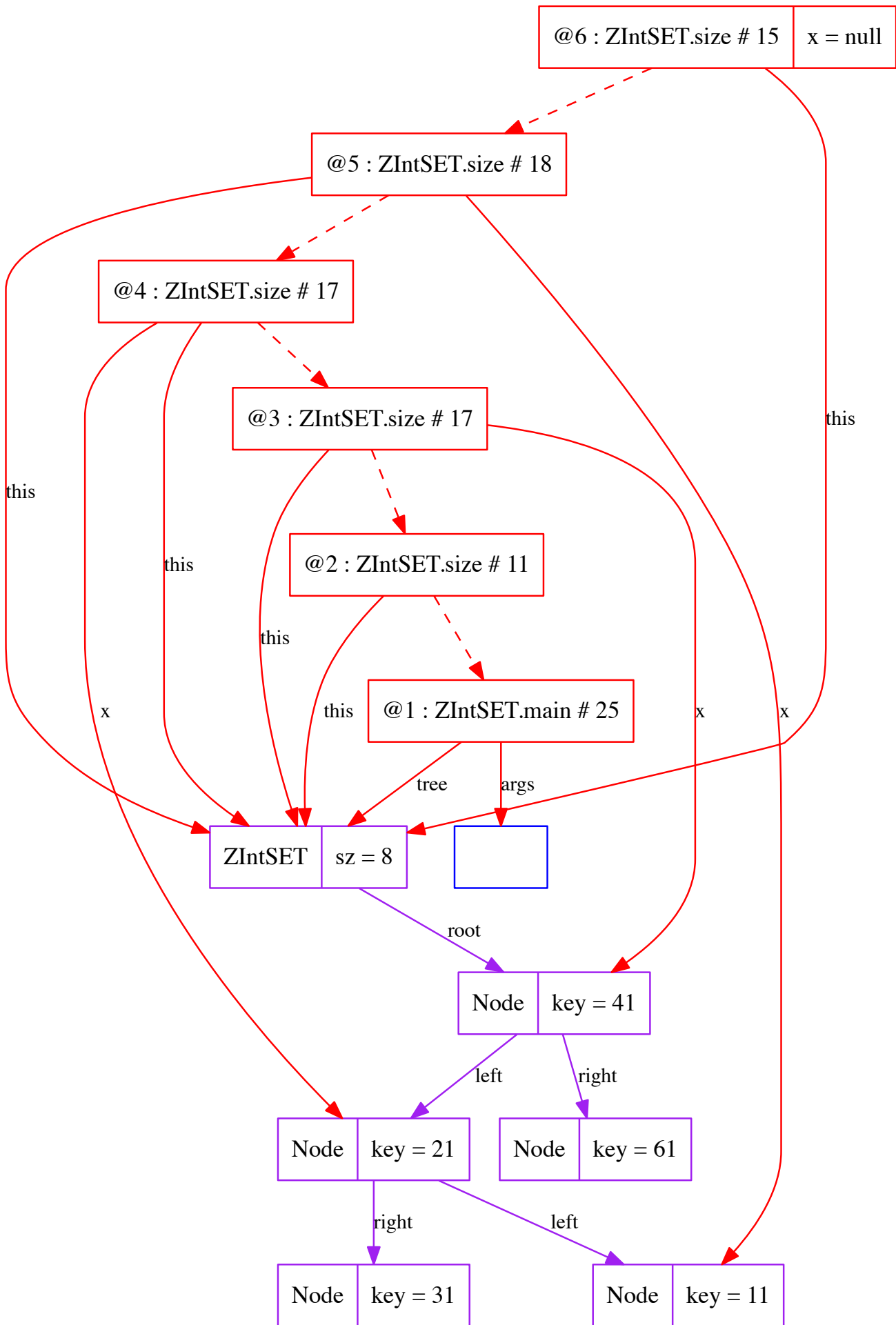

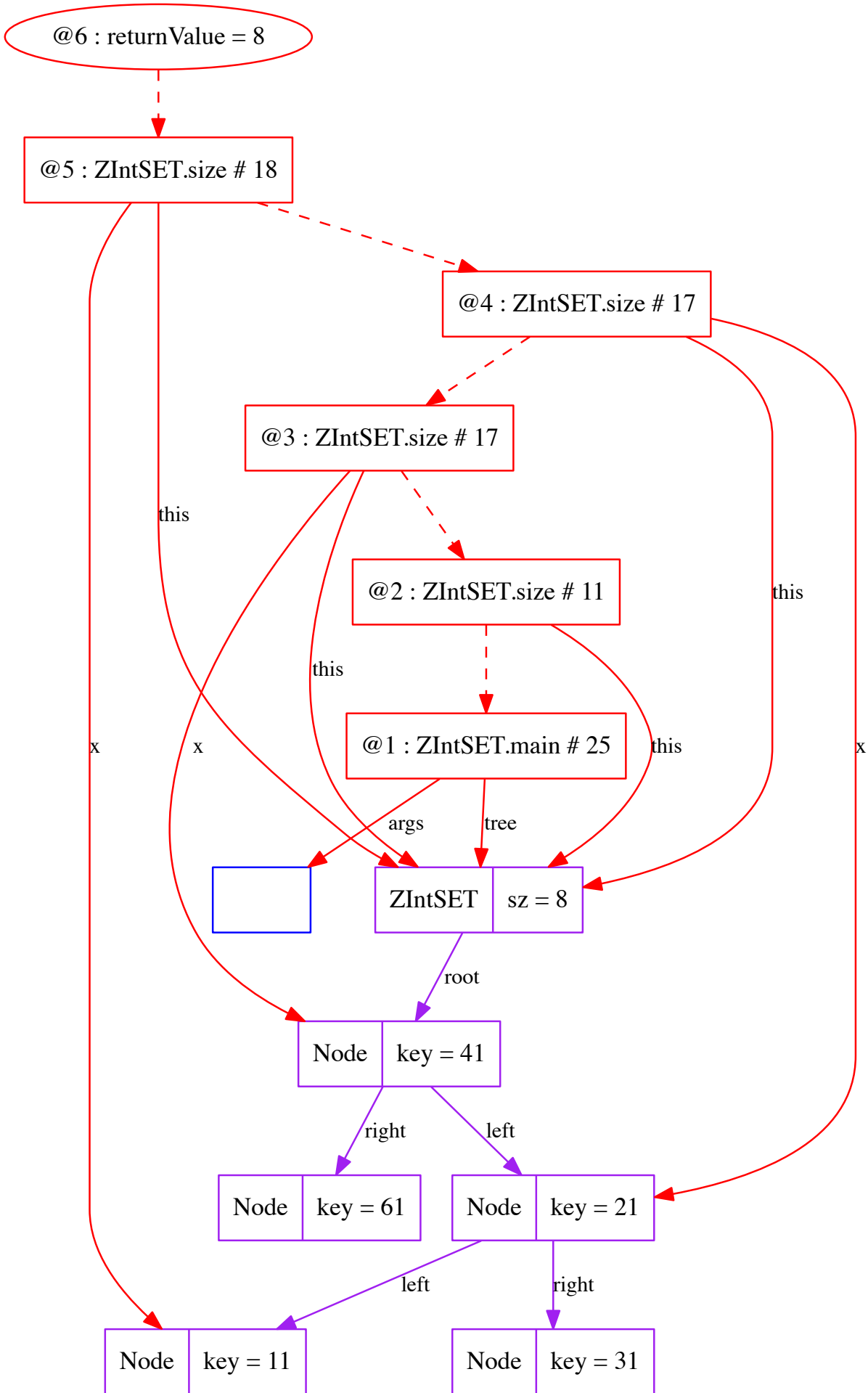

@5 : ZIntSET.size # 19

@4 : ZIntSET.size # 17

@3 : ZIntSET.size # 17

@2 : ZIntSET.size # 11

@1 : ZIntSET.main # 25

ZIntSET sz = 8

Node key = 41

Node key = 61

Node key = 21

Node key = 11

Node key = 31

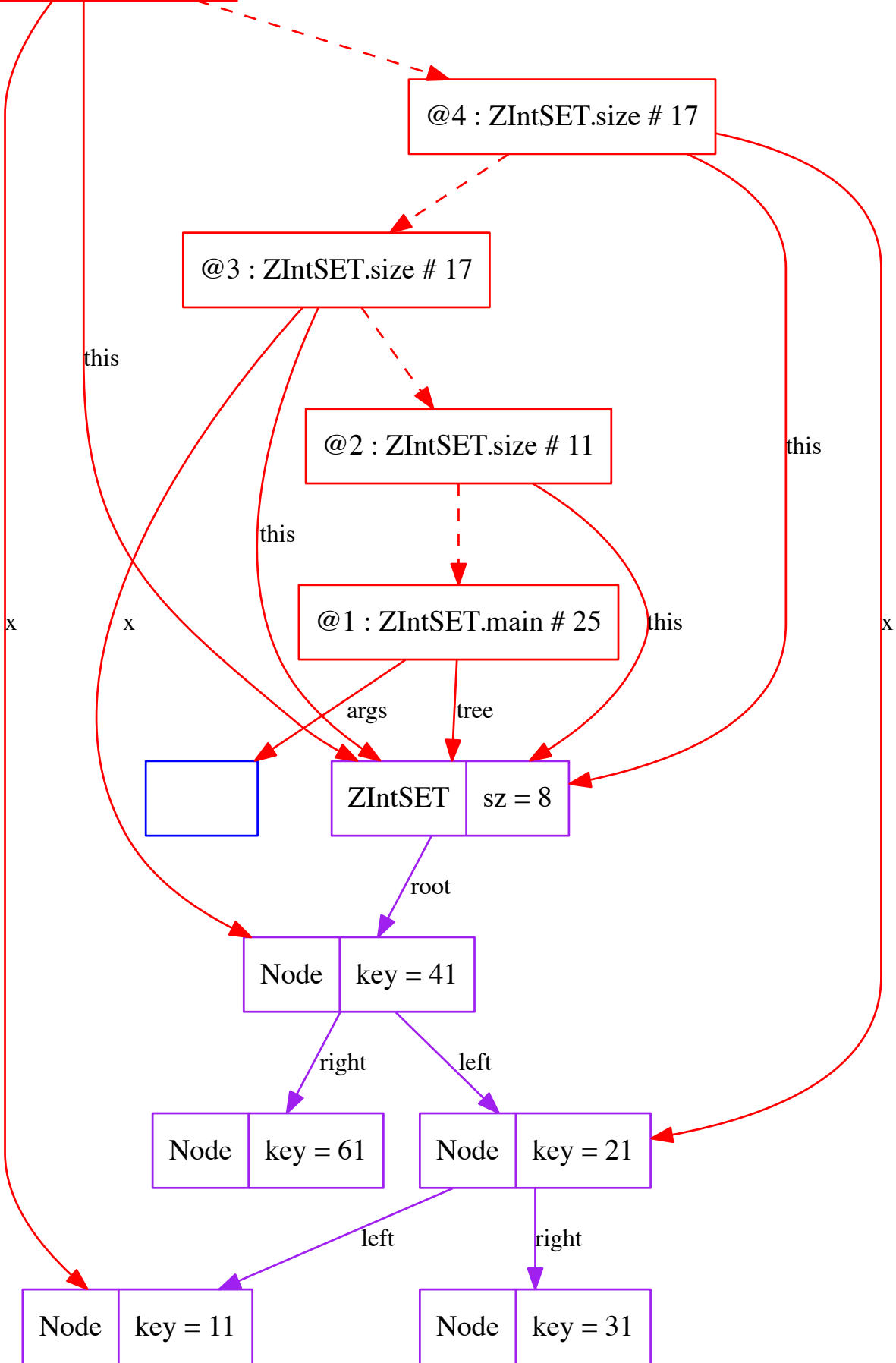

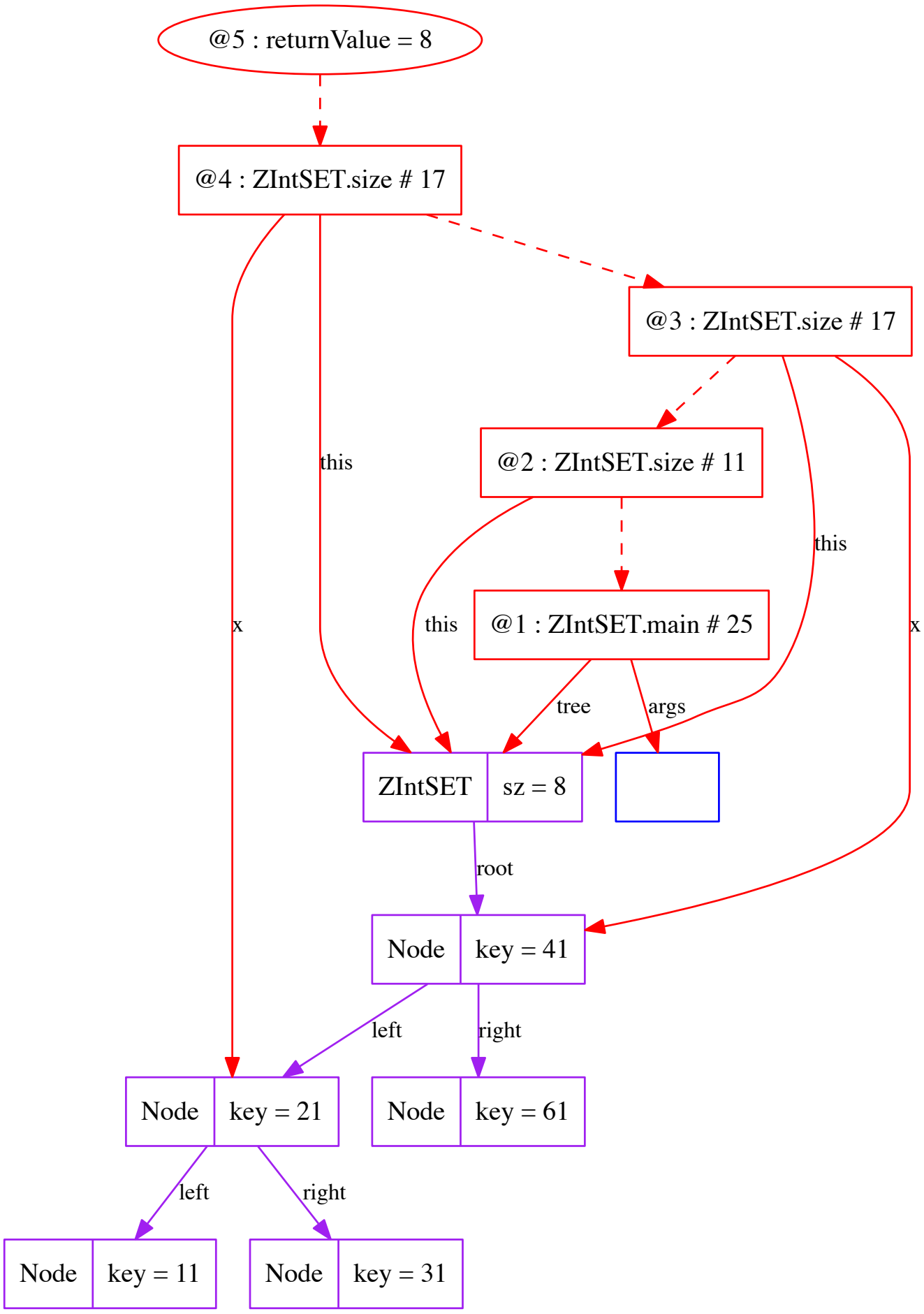

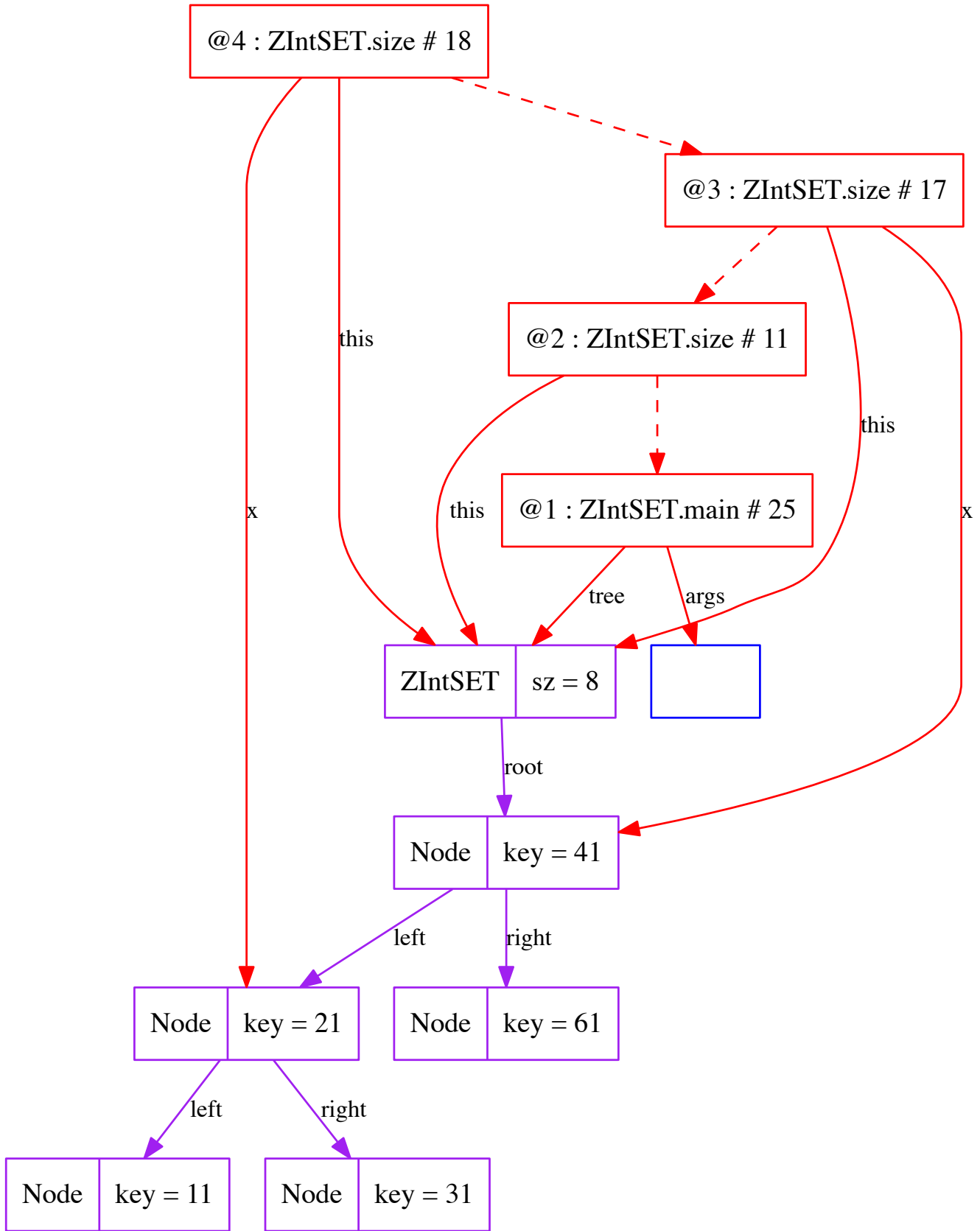

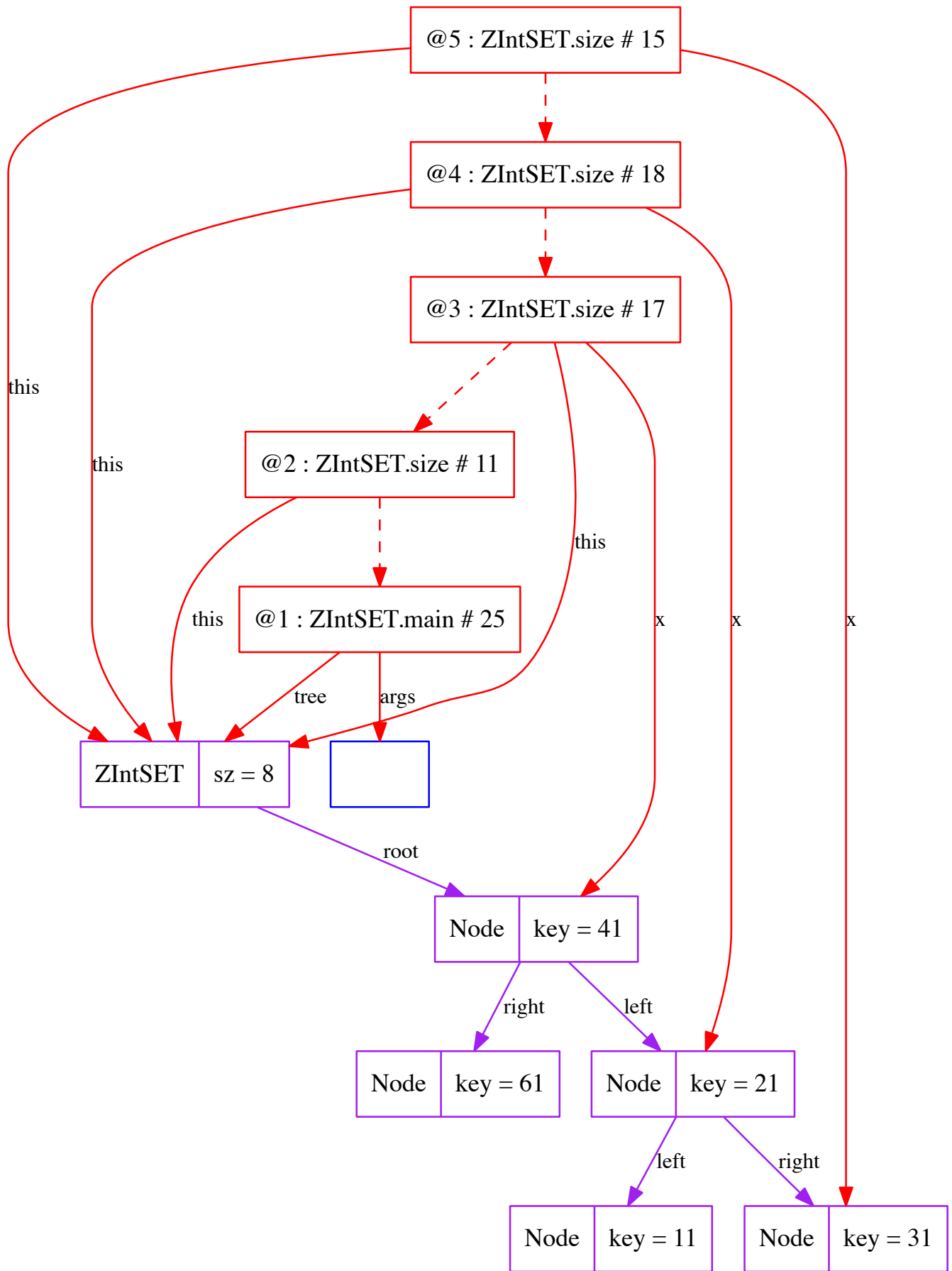

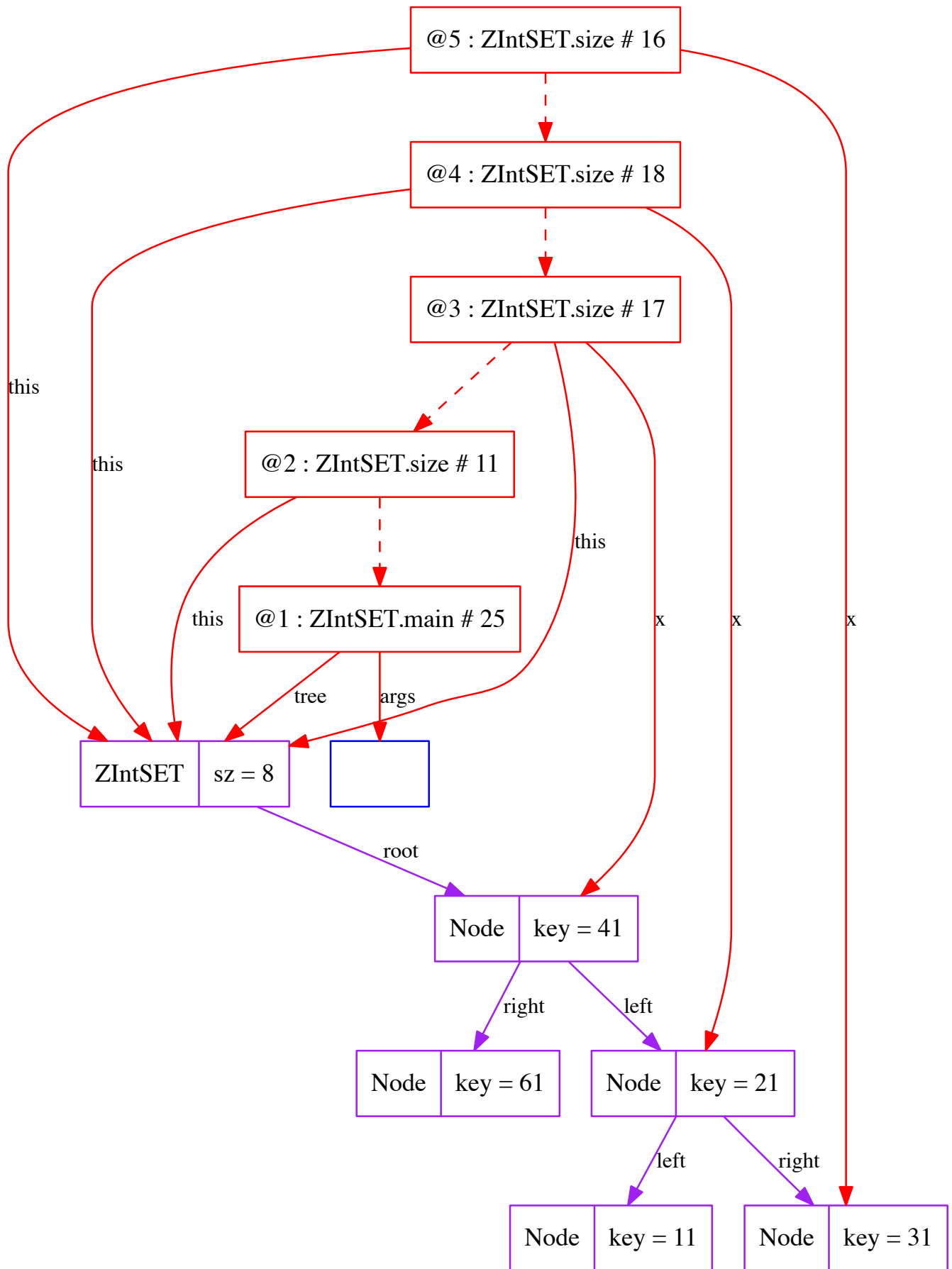

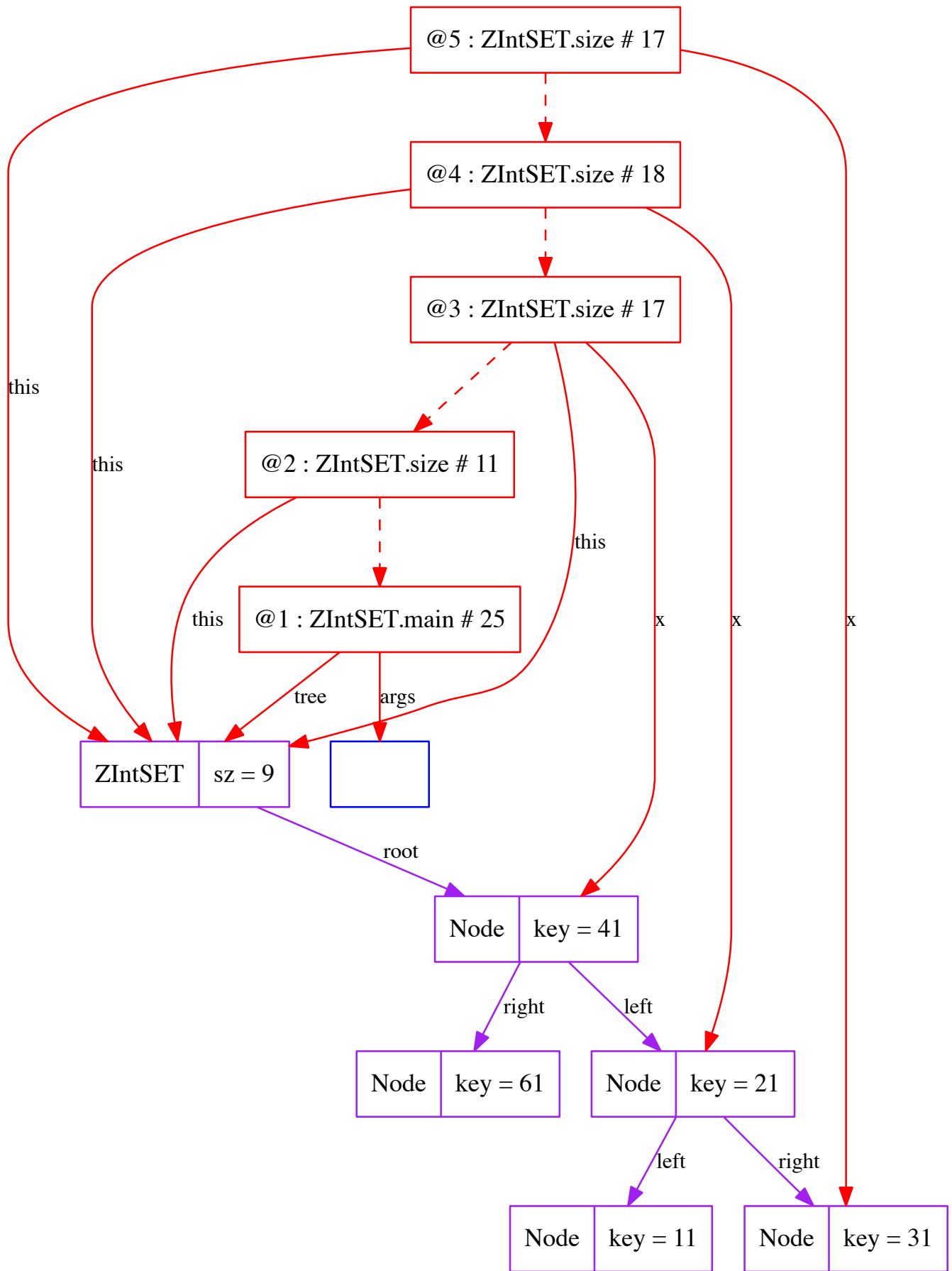

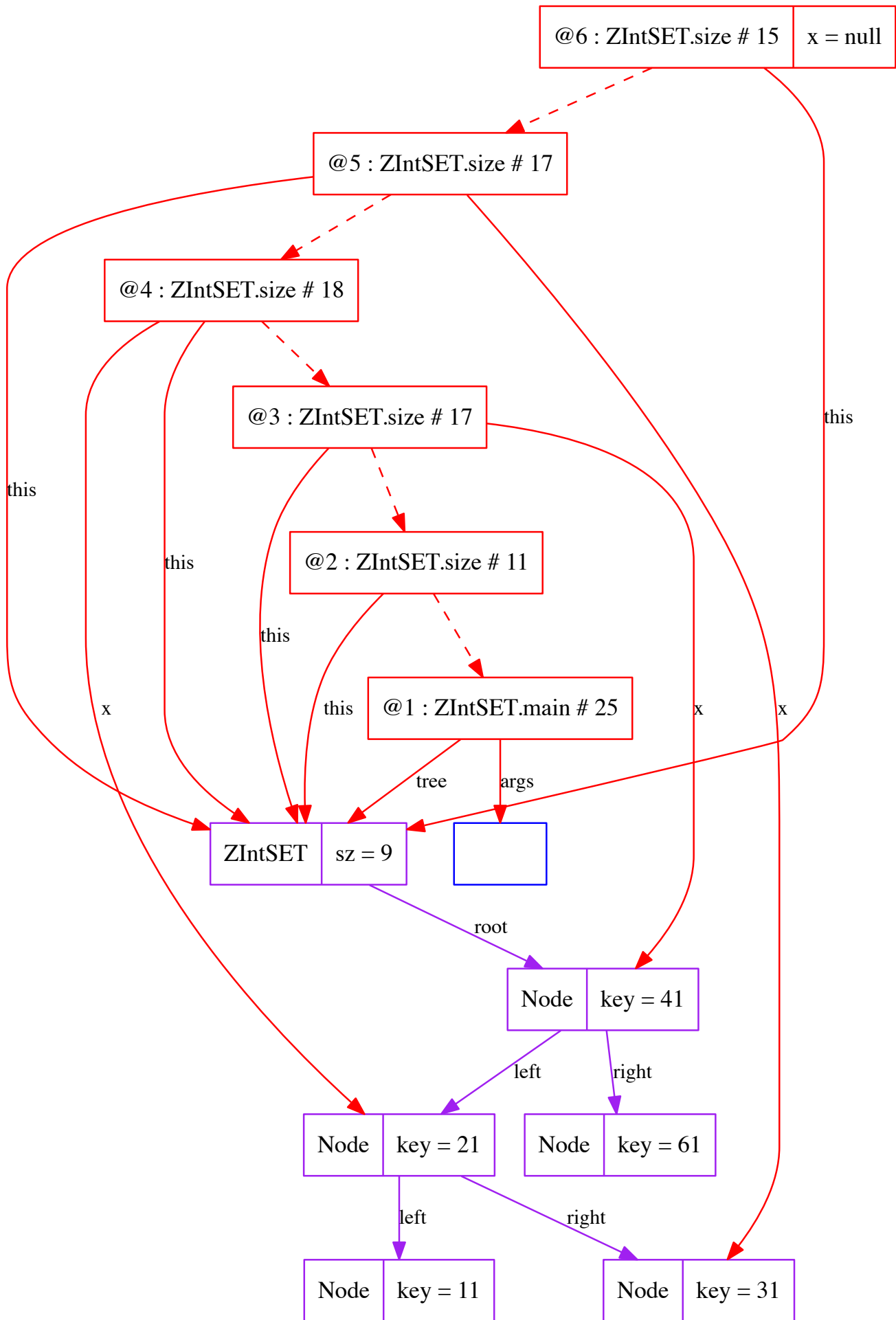

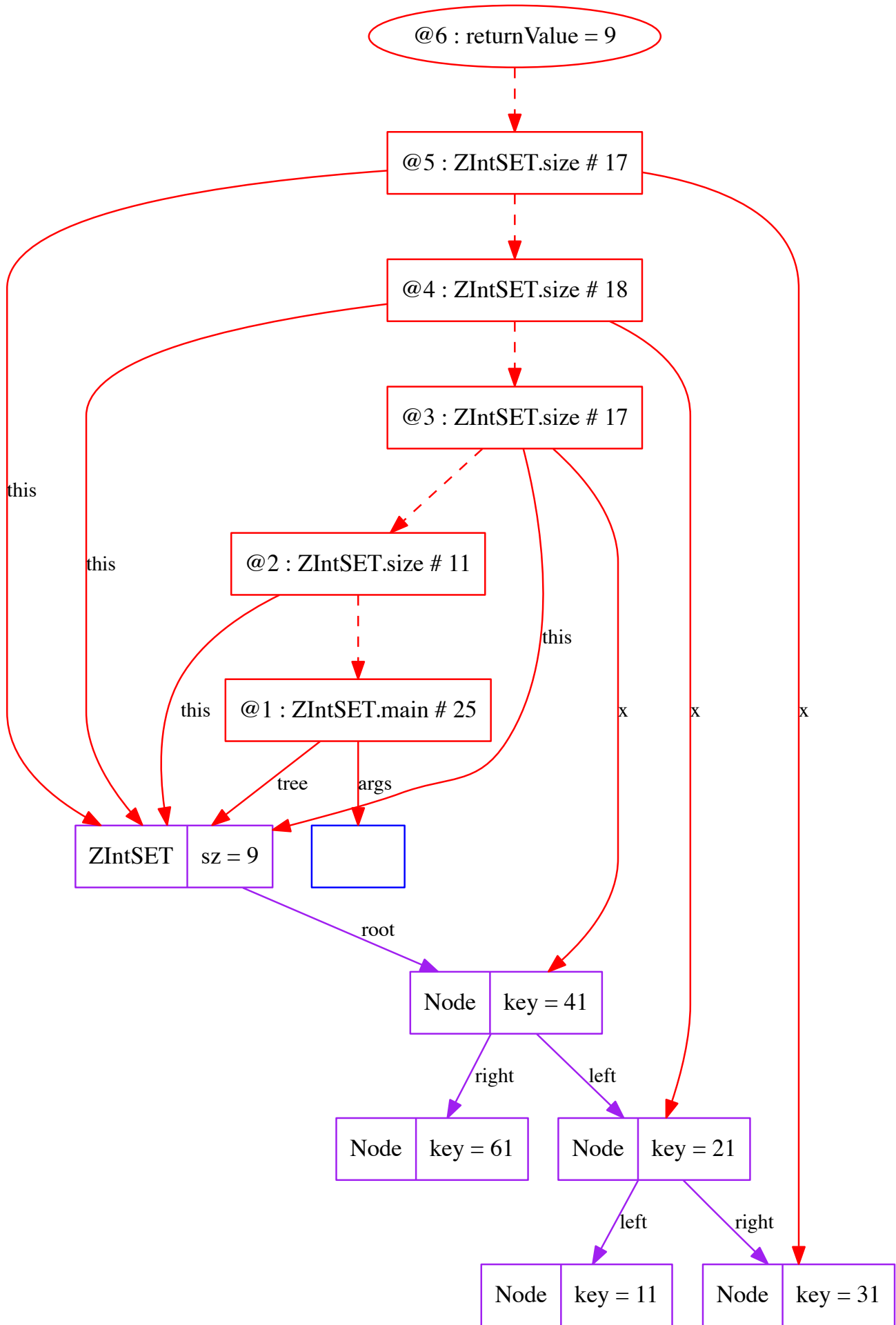

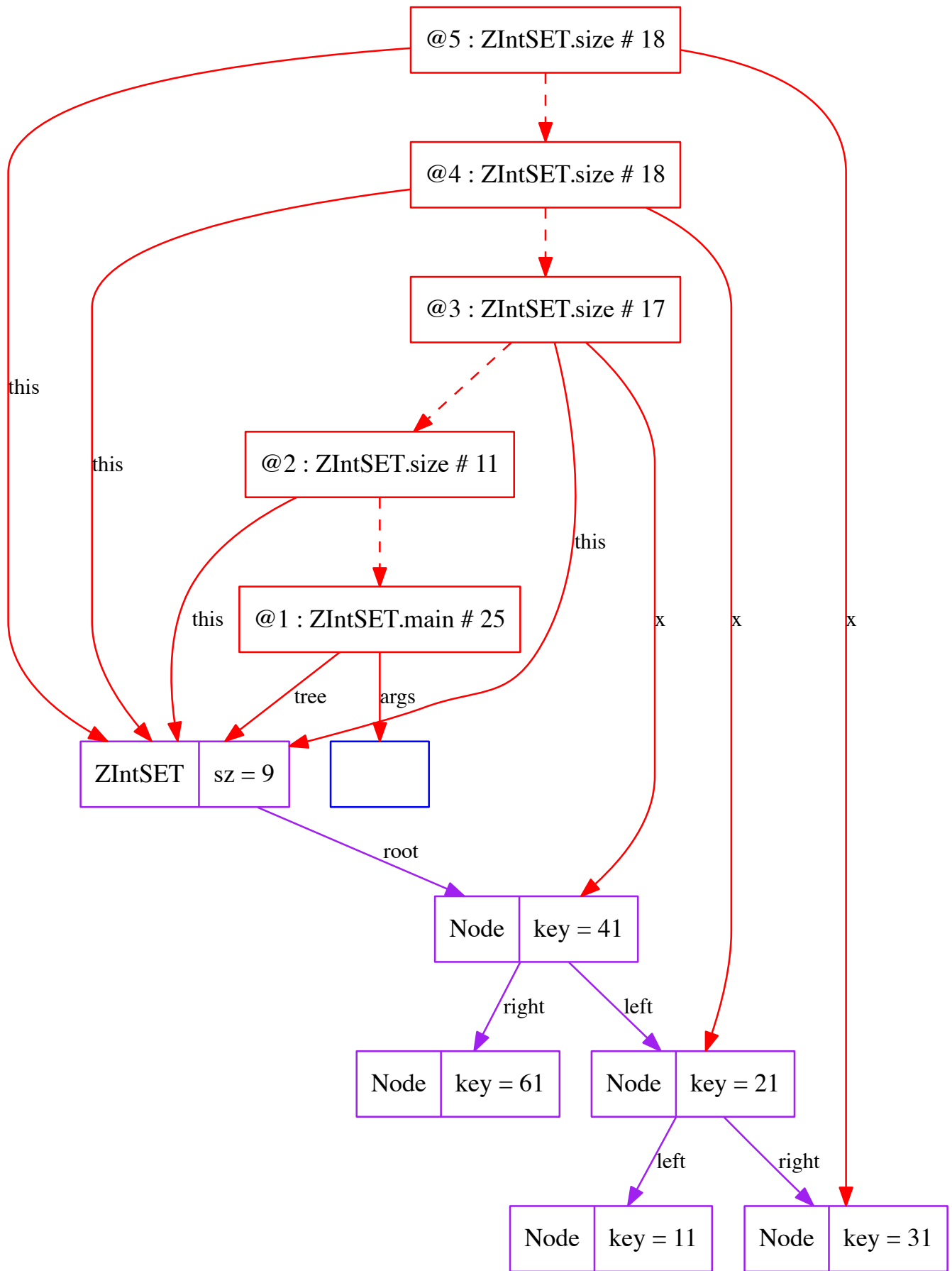

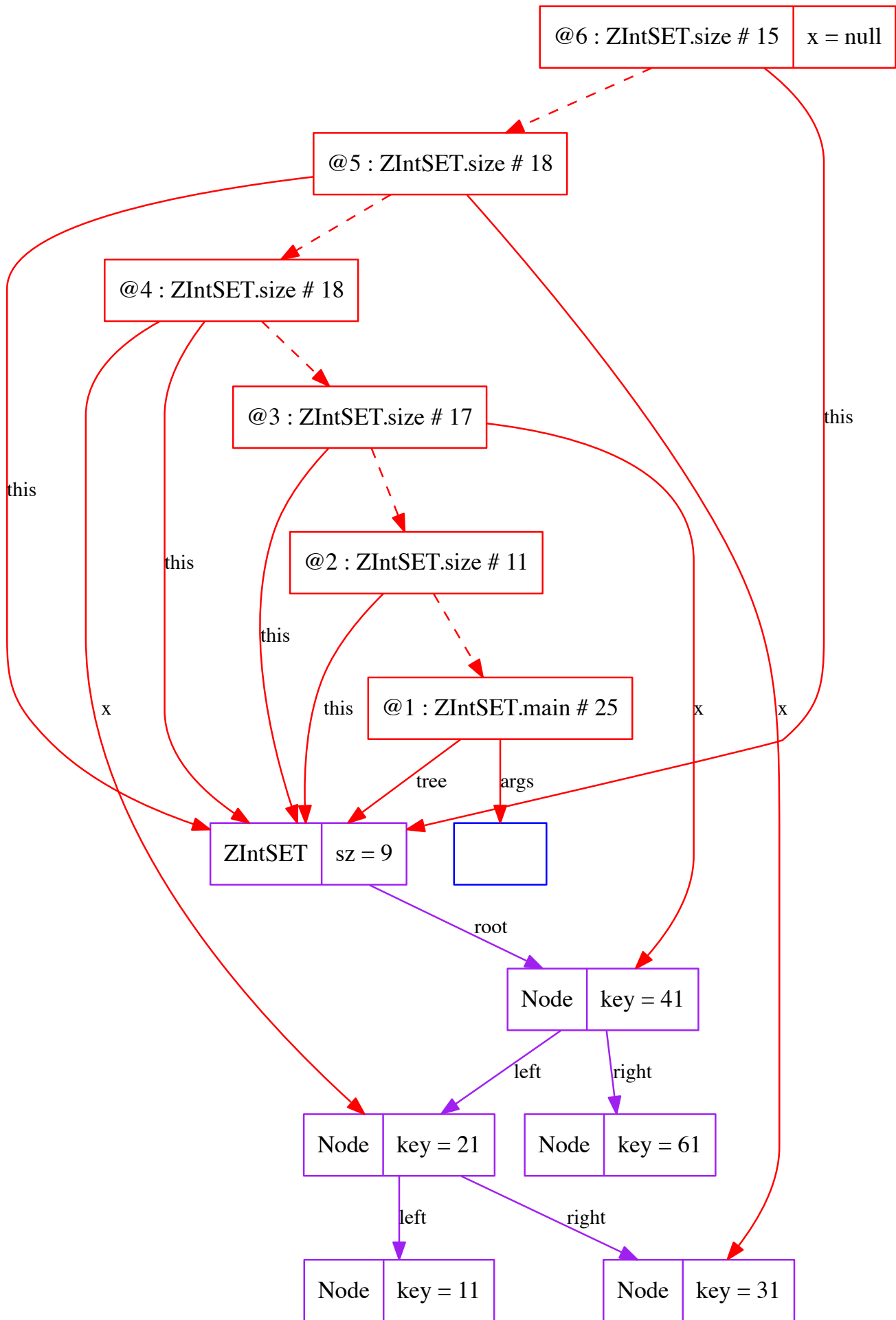

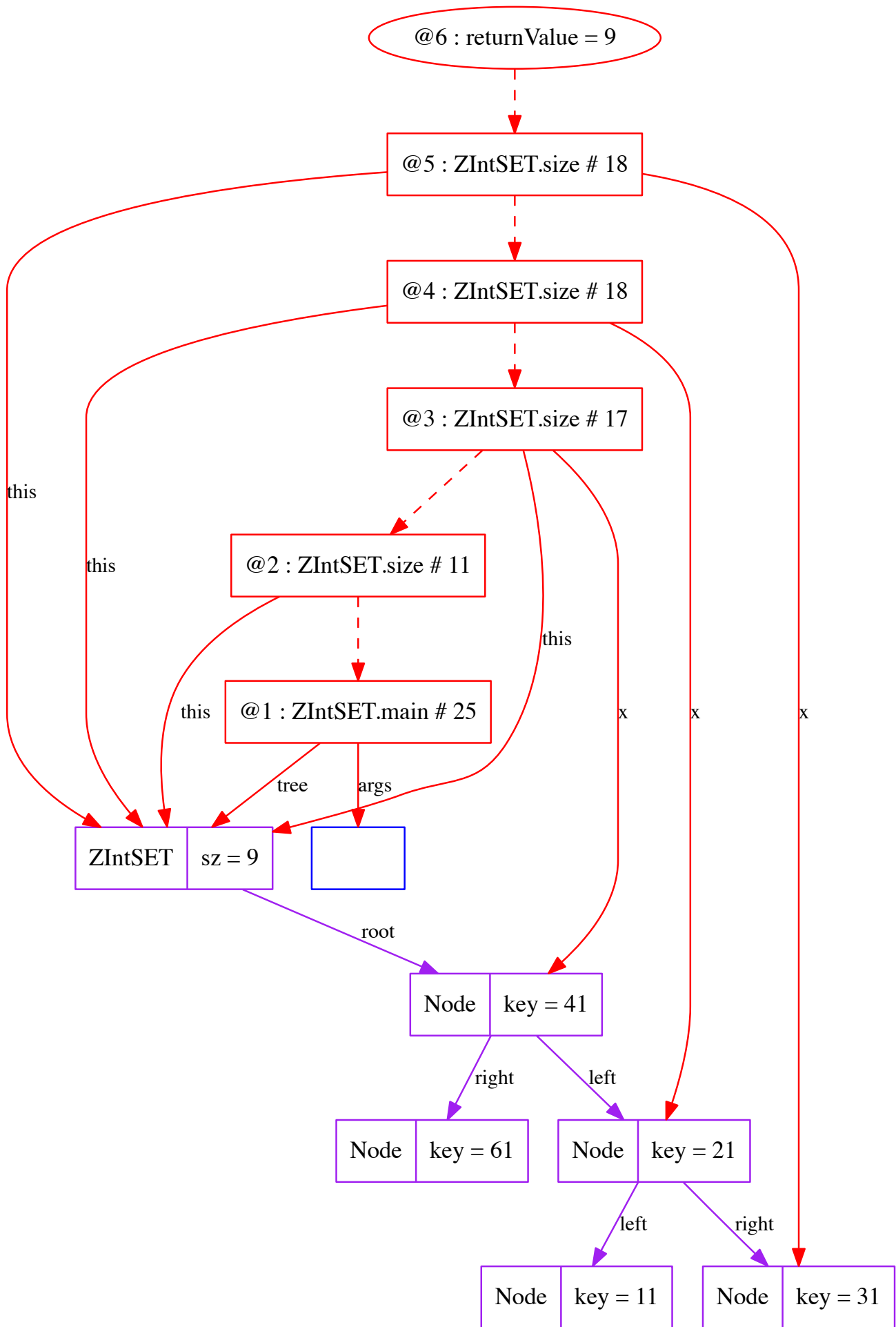

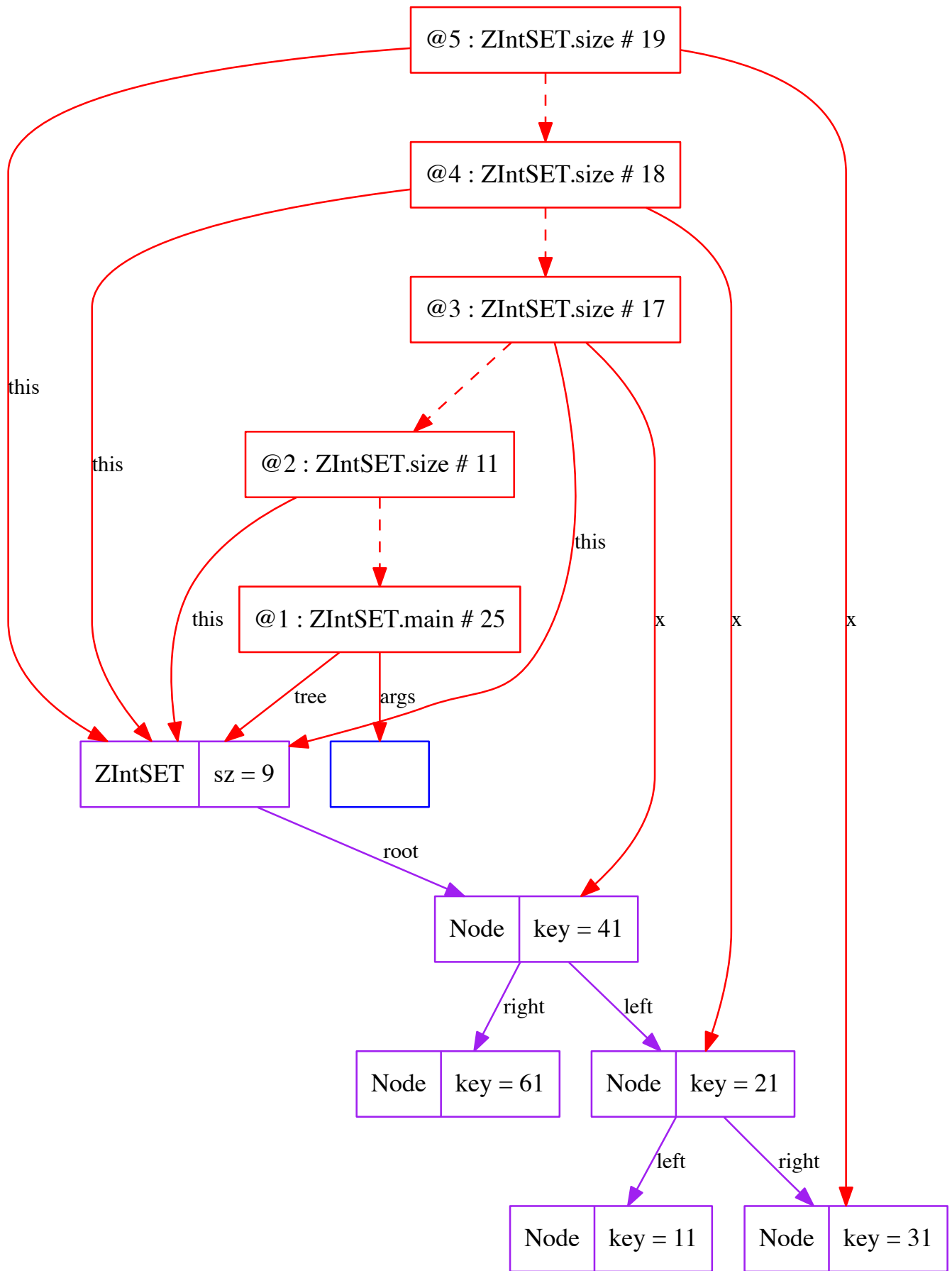

@5 : returnValue = 9

@4 : ZIntSET.size # 18

@3 : ZIntSET.size # 17

@2 : ZIntSET.size # 11

@1 : ZIntSET.main # 25

ZIntSET sz = 9

Node key = 41

Node key = 21

Node key = 61

Node key = 11

Node key = 31

